

The logo for HIRD, featuring the word "HIRD" in bold yellow capital letters centered within a white double-arc shape on a blue background.

**HIRD**

[www.hird.co.uk](http://www.hird.co.uk)

## OPERATORS MANUAL

# MAEDA MINI CRANE MC305-2



**Northern** (Head Office)  
Tel: +44 (0)1482 227333

**Central**  
Tel: +44 (0)1302 341659

**Western**  
Tel: +44 (0)1384 900388

**Southern**  
Tel: +44 (0)203 174 0658

# CONTENTS

| ITEM  | Page |
|---|------|
| <b>INTRODUCTION</b>                               | 1- 1 |
| 1. INTRODUCTION                                   | 1- 2 |
| 2.FOR SAFE USE OF MACHINE                         | 1- 3 |
| 3. MACHINE OVERVIEW                               | 1- 4 |
| 3.1 SPECIFIED OPERATIONS                          | 1- 4 |
| 3.2 MACHINE CONFIGURATION                         | 1- 4 |
| 3.3 MACHINE FUNCTIONS                             | 1- 5 |
| 4. QUALIFICATION FOR OPERATION                    | 1- 6 |
| 4.1 QUALIFICATION FOR CRANE OPERATION             | 1- 6 |
| 5. TERMINOLOGY                                    | 1- 7 |
| 5.1 DEFINITIONS OF TERMS                          | 1- 7 |
| 5.2 DIAGRAM OF WORKING RADIUS AND LIFTING HEIGHT  | 1- 8 |
| 5.3 RATED TOTAL LOAD TABLE                        | 1- 9 |
| 5.4 LOAD INDICATOR                                | 1-15 |
| <b>SAFETY</b>                                     | 2- 1 |
| 1. BASIC PRECAUTIONS                              | 2- 2 |
| 2. DRIVING RELATED PRECAUTIONS                    | 2- 7 |
| 2.1 BEFORE STARTING ENGINE                        | 2- 7 |
| 2.2 AFTER STARTING ENGINE                         | 2- 8 |
| 2.3 WORKING WITH CRANE                            | 2-12 |
| 3. TRANSPORT PRECAUTIONS                          | 2-21 |
| 4. BATTERY HANDLING PRECAUTIONS                   | 2-23 |
| 5. MAINTENANCE PRECAUTIONS                        | 2-25 |
| 5.1 PRECAUTIONS BEFORE MAINTENANCE                | 2-25 |
| 5.2 PRECAUTIONS DURING MAINTENANCE                | 2-27 |
| 6. SAFETY LABEL LOCATIONS                         | 2-32 |
| 7. WEEE DIRECTIVE LABEL LOCATIONS                 | 2-42 |
| <b>OPERATION</b>                                  | 3- 1 |
| 1. MACHINE EACH SECTION                           | 3- 2 |
| 1.1 MACHINE EACH UNIT                             | 3- 2 |
| 1.2 TRAVELING AND CRANE OPERATION UNITS           | 3- 3 |
| 1.3 INSTRUMENT PANEL SECTIONS                     | 3- 6 |
| 1.3.1 DESCRIPTION OF EACH SWITCHES                | 3- 7 |
| 1.3.2 DESCRIPTION OF EACH MONITORS                | 3-10 |
| 1.3.3 DESCRIPTION OF FUSES                        | 3-12 |
| 1.4 OUTRIGGER OPERATION PANEL                     | 3-13 |
| 1.5 OUTRIGGER SAFETY DEVICES                      | 3-15 |
| 1.5.1 FUNCTIONS OF OUTRIGGER SAFETY DEVICES       | 3-15 |
| 1.5.2 NAMES AND DESCRIPTIONS OF OUTRIGGER DISPLAY | 3-16 |
| 1.5.3 OUTRIGGER UN-SET WARNING LAMP               | 3-17 |
| 1.6 MOMENT LIMITER (OVERLOAD DETECTOR)            | 3-18 |
| 1.6.1 MOMENT LIMITER CONFIGURATION                | 3-18 |
| 1.6.2 FUNCTION OF MOMENT LIMITER                  | 3-19 |

| <b>ITEM</b>   | <b>Page</b> |
|---|-------------|
| 1.6.3 MOMENT LIMITER OPERATIONS                           | 3-20        |
| 1.6.4 NAMES OF MOMENT LIMITER DISPLAY UNIT                | 3-22        |
| 1.6.5 MOMENT LIMITER FUNCTIONS                            | 3-29        |
| 1.6.6 MOMENT LIMITER STARTING STATUS                      | 3-31        |
| 1.6.7 MOMENT LIMITER WORKING ENVELOPE SETTING             | 3-32        |
| 1.6.8 EMERGENCY STOP CANCEL SWITCH                        | 3-33        |
| 1.6.9 MOMENT LIMITER ERROR CAUSES AND ACTIONS TO BE TAKEN | 3-34        |
| 1.7 OVER HOIST DETECTOR                                   | 3-35        |
| 1.8 OPERATION SEAT  | 3-36        |
| 1.9 ENGINE HOOD   | 3-37        |
| 1.10 MACHINERY COVER                                      | 3-38        |
| 2. OPERATIONS   | 3-40        |
| 2.1 CHECKING BEFORE OPERATION                             | 3-40        |
| 2.1.1 CHECKING BEFORE STARTING ENGINE (VISIBLE CHECKS)    | 3-40        |
| 2.1.2 CHECKING BEFORE STARTING ENGINE                     | 3-43        |
| 2.1.3 CHECKING AFTER STARTING ENGINE                      | 3-56        |
| 2.2 STARTING ENGINE                                       | 3-66        |
| 2.2.1 NORMAL ENGINE START                                 | 3-66        |
| 2.2.2 STARTING ENGINE IN COLD WEATHER                     | 3-67        |
| 2.3 OPERATIONS AND CHECKS AFTER STARTING ENGINE           | 3-68        |
| 2.4 BREAKING-IN MACHINE                                   | 3-70        |
| 2.5 MACHINE TRAVELING POSTURE                             | 3-70        |
| 2.6 STARTING MOVING MACHINE                               | 3-71        |
| 2.7 CHANGING MACHINE TRAVELING MODE                       | 3-72        |
| 2.8 CHANGING PATH OF MACHINE                              | 3-72        |
| 2.9 STOPPING/PARKING MACHINE                              | 3-74        |
| 2.10 STOPPING ENGINE                                      | 3-75        |
| 2.11 INSPECTION AFTER STOPPING ENGINE                     | 3-75        |
| 2.12 CAUTIONS IN DRIVING                                  | 3-76        |
| 2.13 DESCRIPTION ON OUTRIGGER AND CRANE SAFETY DEVICES    | 3-78        |
| 2.14 OUTRIGGER SETTING OPERATION                          | 3-82        |
| 2.14.1 NAME OF OUTRIGGER COMPONENTS                       | 3-84        |
| 2.14.2 OUTRIGGER SETTING OPERATION                        | 3-84        |
| 2.15 CAUTIONS BEFORE CRANE OPERATION                      | 3-88        |
| 2.16 OPERATIONS BEFORE CRANE OPERATIONS                   | 3-89        |
| 2.17 CRANE OPERATION POSTURE                              | 3-90        |
| 2.18 HOOK RAISING/LOWERING OPERATION                      | 3-90        |
| 2.19 BOOM DERRICKING OPERATION                            | 3-91        |
| 2.20 BOOM TELESCOPING OPERATION                           | 3-92        |
| 2.21 SLEWING OPERATION                                    | 3-93        |
| 2.22 ACCELERATION OPERATION                               | 3-93        |
| 2.23 CRANE STOWING OPERATION                              | 3-94        |
| 2.24 OUTRIGGER STOWING OPERATION                          | 3-96        |
| 2.25 DOS AND DON'TS DURING CRANE OPERATIONS               | 3-100       |

| <b>ITEM</b>  | <b>Page</b> |
|--|-------------|
| 3. HANDLING RUBBER TRACKS                            | 3-102       |
| 3.1 GOOD USE   | 3-102       |
| 3.2 WARRANTY   | 3-102       |
| 3.3 DOS AND DON'TS                                   | 3-103       |
| 3.4 CAUTIONS IN USING RUBBER TRACKS                  | 3-104       |
| 4. HANDLING WIRE ROPES                               | 3-106       |
| 4.1 BENCH MARK FOR REPLACING WIRE ROPES              | 3-106       |
| 4.2 What TO DO WITH TWISTED WINCH WIRE ROPE          | 3-107       |
| 5. TRANSPORTATION                                    | 3-108       |
| 5.1 LOADING/UNLOADING                                | 3-108       |
| 5.2 HOISTING MACHINE                                 | 3-109       |
| 5.3 CAUTIONS IN LOADING MACHINE                      | 3-110       |
| 5.4 CAUTIONS DURING TRANSPORTATION                   | 3-110       |
| 6. HANDLING IN COLD WEATHER                          | 3-111       |
| 6.1 PREPARING FOR LOW TEMPERATURE                    | 3-111       |
| 7. LONG-TERM STORAGE                                 | 3-113       |
| 7.1 BEFORE STORING MACHINE                           | 3-113       |
| 7.2 DURING STORAGE                                   | 3-113       |
| 7.3 AFTER STORAGE                                    | 3-113       |
| 8. HANDLING BATTERY                                  | 3-114       |
| 8.1 CAUTIONS IN HANDLING BATTERY                     | 3-114       |
| 8.2 REMOVING/INSTALLING BATTERY                      | 3-115       |
| 8.3 CAUTIONS IN CHARGING BATTERY                     | 3-116       |
| 8.4 STARTING ENGINE WITH BOOSTER CABLE               | 3-117       |
| 9. TROUBLESHOOTING                                   | 3-119       |
| 9.1 ELECTRICAL COMPONENTS                            | 3-119       |
| 9.2 MACHINE BODY                                     | 3-120       |
| 9.3 ENGINE   | 3-121       |
| <b>INSPECTION AND MAINTENANCE</b>                    | 4- 1        |
| 1. PRECAUTIONS FOR MAINTENANCE                       | 4- 2        |
| 2. BASIC MAINTENANCE                                 | 4- 4        |
| 3. LEGAL INSPECTION                                  | 4- 6        |
| 4. CONSUMABLES                                       | 4- 6        |
| 5. LUBRICATING OIL                                   | 4- 7        |
| 5.1 USE OF LUBRICATING OIL ACCORDING TO TEMPERATURES | 4- 7        |
| 6. ACCESSORY TOOLS AND STANDARD TIGHTENING TORQUE    | 4- 8        |
| 6.1 ACCESSORY TOOLS                                  | 4- 8        |
| 6.2 STANDARD TIGHTENING TORQUE LIST                  | 4- 8        |
| 7. INSPECTION AND MAINTENANCE LIST                   | 4-10        |
| 8. MAINTENANCE PROCEDURES                            | 4-12        |
| 8.1 INITIAL 10 HOUR MAINTENANCE                      | 4-12        |
| 8.2 INITIAL 50 HOUR MAINTENANCE                      | 4-12        |
| 8.3 INITIAL 250 HOUR MAINTENANCE                     | 4-12        |
| 8.4 CHECKING BEFORE OPERATION                        | 4-12        |
| 8.5 IRREGULAR MAINTENANCE                            | 4-13        |
| 8.6 MAINTENANCE EVERY 30 HOURS                       | 4-22        |

| <b>ITEM</b>                                      | <b>Page</b> |
|--|-------------|
| 8.7 MAINTENANCE EVERY 50 HOURS                   | 4-24        |
| 8.8 MAINTENANCE EVERY 250 HOURS                  | 4-28        |
| 8.9 MAINTENANCE EVERY 500 HOURS                  | 4-32        |
| 8.10 MAINTENANCE EVERY 1000 HOURS                | 4-36        |
| 8.11 MAINTENANCE EVERY 1500 HOURS                | 4-45        |
| 8.12 MAINTENANCE EVERY 2000 HOURS                | 4-45        |
| <b>SPECIFICATIONS</b>                            | 5- 1        |
| 1. SPECIFICATION LIST                            | 5- 2        |
| 2. SPECIFICATION DIMENSIONAL DRAWING             | 5- 4        |
| 3. DIMENSIONAL DRAWING OF OUTRIGGER WIDTH        | 5- 5        |
| 4. RATED TOTAL LOAD TABLE                        | 5- 6        |
| 5. WORKING RADIUS AND LIFTING HEIGHT             | 5- 9        |
| <b>INTERACTIVE REMOTE CONTROL</b>                | 6- 1        |
| 1. OUTLINE OF REMOTE CONTROLLER                  | 6- 2        |
| 1.1 FEATURE                                      | 6- 2        |
| 1.2 CONFIGURATION                                | 6- 2        |
| 1.3 FUNCTIONS OF REMOTE CONTROL SYSTEM           | 6- 3        |
| 2. SAFETY PRECAUTIONS                            | 6- 4        |
| 2.1 For Safety Operations                        | 6- 4        |
| 2.2 PRECAUTIONS FOR CRANE OPERATION              | 6- 6        |
| 2.2.1 PRIOR TO STARTING ENGINE                   | 6- 6        |
| 2.2.2 SUBSEQUENT TO STARTING ENGINE              | 6- 7        |
| 2.2.3 TERMINATING THE OPERATION                  | 6- 7        |
| 3. LOCATIONS OF SAFETY LABELS                    | 6- 8        |
| 4. COMPONENTS OF THE TRANSMITTER                 | 6-10        |
| 5. COMPONENTS OF THE RECEIVER                    | 6-16        |
| 5.1 COMPONENTS OF THE RECEIVER                   | 6-16        |
| 5.2 FUSE IN THE RECEIVER                         | 6-18        |
| 6. SETTING UP OPERATION MODES OF TRANSMITTER     | 6-20        |
| 6.1 A MODE                                       | 6-20        |
| 6.1.1 OPENING A MODE SCREEN                      | 6-20        |
| 6.1.2 MESSAGES IN THE A MODE SCREEN              | 6-20        |
| 6.1.3 AN EXAMPLE FOR SETTING IN THE A MODE       | 6-24        |
| 6.2 PROCEDURE IN THE OPERATION MODE              | 6-25        |
| 6.2.1 CALL OUT CRANE MODE                        | 6-25        |
| 6.2.2 CALL OUT OUTRIGGER MODE                    | 6-26        |
| 7. CHECKING BEFORE OPERATION                     | 6-28        |
| 7.1 CHECKING BEFORE STARTING ENGINE              | 6-28        |
| 7.1.1 CHECKING BEFORE TURNING ON THE TRANSMITTER | 6-28        |
| 7.1.2 CHECKING AFTER TURNING ON THE TRANSMITTER  | 6-29        |
| 7.1.3 CHECKING RECEIVER                          | 6-32        |
| 7.2 CHECKING AFTER STARTING ENGINE               | 6-33        |
| 7.2.1 VERIFICATION FOR THE ENGINE START AND STOP | 6-33        |
| 7.2.2 CHECKING "OUTRIGGER MODE" OPERATION        | 6-34        |
| 7.2.3 CHECKING "CRANE MODE" OPERATION            | 6-36        |

| <b>ITEM</b>  | <b>Page</b> |
|--|-------------|
| 8. OPERATION   | 6-39        |
| 8.1 CAUTIONS BEFORE OPERATION                                  | 6-39        |
| 8.2 OPERATION IN OUTRIGGER MODE                                | 6-40        |
| 8.2.1 OUTRIGGER SETTING  | 6-41        |
| 8.2.2 OUTRIGGER STOWAGE  | 6-42        |
| 8.3 OPERATION IN CRANE MODE                                    | 6-43        |
| 8.3.1 SLEWING OPERATION  | 6-44        |
| 8.3.2 BOOM TELESCOPING   | 6-44        |
| 8.3.3 HOOK RAISING AND LOWERING                                | 6-45        |
| 8.3.4 BOOM DERRICKING  | 6-45        |
| 8.3.5 AUTOMATIC HOOK STOW FUNCTION                             | 6-46        |
| 8.3.6 SET-UP AND CANCEL MICRO SPEED AND ENHANCED SPEED MODE    | 6-47        |
| 8.3.7 ENGINE STOP AND EMERGENCY STOP PROCEDURE                 | 6-49        |
| 8.3.8 ENGINE START AND RESET PROCEDURE                         | 6-49        |
| 8.4 CHECKING AFTER CRANE OPERATION                             | 6-50        |
| 9. TROUBLE SHOOTING  | 6-51        |
| 9.1 BEFORE THE TROUBLE SHOOTING                                | 6-51        |
| 9.2 ERRORS IN THE REMOTE CONTROL DEVICES                       | 6-52        |
| 10.SYSTEM SPECIFICATIONS                                       | 6-54        |
| <b>ENGINE AND ELECTRIC MOTOR SPECIFICATIONS</b>                | 7- 1        |
| 1. PRECAUTIONS (FOR ENGINE AND ELECTRIC MOTOR SPECIFICATION)   | 7- 2        |
| 2. SAFETY LABEL LOCATIONS                                      | 7- 3        |
| 3. MACHINE EACH SECTION  | 7- 5        |
| 3.1 MACHINE EACH UNIT  | 7- 5        |
| 3.2 TRAVELING AND CRANE OPERATION UNITS                        | 7- 6        |
| 3.3 INSTRUMENT PANEL SECTIONS                                  | 7- 7        |
| 3.4 POWER UNIT   | 7-10        |
| 3.5 POWER SUPPLY BOX   | 7-10        |
| 3.6 INVERTER UNIT  | 7-11        |
| 4. OPERATION   | 7-14        |
| 4.1 CHECKING BEFORE OPERATION                                  | 7-14        |
| 4.1.1 CHECKING BEFORE STARTING ELECTRIC MOTOR (VISIBLE CHECKS) | 7-14        |
| 4.1.2 CHECKING BEFORE STARTING ELECTRIC MOTOR                  | 7-14        |
| 4.1.3 CHECKING AFTER STARTING ELECTRIC MOTOR                   | 7-14        |
| 4.2 POWER SUPPLY CONNECTION                                    | 7-15        |
| 4.3 OPERATION AND CHECKING AFTER POWER CONNECTION              | 7-17        |
| 4.4 MACHINE OPERATION  | 7-19        |
| 4.5 MACHINE STOP AND CHECKS AFTER STOPPING MACHINE             | 7-19        |
| 4.6 POWER SUPPLY SEPARATION                                    | 7-20        |
| 5. LONG-TERM STORAGE   | 7-21        |
| 6. ELECTRIC MOTOR TROUBLESHOOTING                              | 7-22        |
| 7. PRINCIPLE SPECIFICATION LIST                                | 7-23        |
| 8. SPECIFICATION DIMENSINAL DRAWING                            | 7-24        |

| <b>ITEM</b>   | <b>Page</b> |
|---|-------------|
| <b>SEARCHER HOOK</b>                                    | 8- 1        |
| 1. SEARCHER HOOK EACH SECTION                           | 8- 2        |
| 2. MOMENT LIMITER DISPLAY UNIT                          | 8- 4        |
| 3. OPERATION  | 8- 6        |
| 4. INSPECTION AND MAINTENANCE                           | 8- 8        |
| 4.1 LEGAL INSPECTION                                    | 8- 8        |
| 4.2 CONSUMABLES   | 8- 8        |
| 4.3 INSPECTION AND MAINTENANCE LIST                     | 8- 8        |
| 4.4 MAINTENANCE PROCEDURES                              | 8- 9        |
| 4.4.1 INSPECTION OF BEFORE OPERATION                    | 8- 9        |
| 5. WORKING RADIUS AND RATED TOTAL LOAD                  | 8-11        |
| 5.1 WORKING RADIUS AND LIFTING HEIGHT FOR SEARCHER HOOK | 8-11        |
| 5.2 RATED TOTAL LOAD CHART FOR SEARCHER HOOK            | 8-12        |
| <b>850kg SEARCHER HOOK</b>                              | 9- 1        |
| 1. SAFETY DECAL LOCATIONS                               | 9- 2        |
| 2. SEARCHER HOOK EACH SECTION                           | 9- 5        |
| 3. MOMENT LIMITER DISPLAY UNIT                          | 9- 6        |
| 4. OPERATION  | 9-10        |
| 5. INSPECTION AND MAINTENANCE                           | 9-14        |
| 5.1 LEGAL INSPECTION                                    | 9-14        |
| 5.2 CONSUMABLES   | 9-14        |
| 5.3 INSPECTION AND MAINTENANCE LIST                     | 9-15        |
| 5.4 MAINTENANCE PROCEDURES                              | 9-16        |
| 5.4.1 INSPECTION OF BEFORE OPERATION                    | 9-16        |
| 6. WORKING RADIUS AND RATED TOTAL LOAD                  | 9-18        |
| 6.1 WORKING RADIUS AND LIFTING HEIGHT FOR SEARCHER HOOK | 9-18        |
| 6.2 RATED TOTAL LOAD CHART FOR SEARCHER HOOK            | 9-20        |

# INTRODUCTION

|                                |      |
|--------------------------------|------|
| 1. INTRODUCTION                | 1- 2 |
| 2. FOR SAFE USE OF MACHINE     | 1- 3 |
| 3. MACHINE OVERVIEW            | 1- 4 |
| 4. QUALIFICATION FOR OPERATION | 1- 6 |
| 5. TERMINOLOGY                 | 1- 7 |



# 1. INTRODUCTION

Thank you for purchasing our Mini Crawler Crane “MC-305C-2”.

This manual is a guidebook for safe and effective use of this machine.

This manual describes the procedures for proper operation and maintenance of the machine.

Warnings and precautions defined in this manual shall be observed for safety.

Many of the accidents are caused by the operation, inspection, or maintenance that does not observe the basic precautions.

Be sure to read this manual and understand the procedures for machine operation, inspection, and maintenance thoroughly before performing operation of this machine.

Failure to observe the basic precautions defined in this manual may lead to hazardous accidents.

## WARNING

**Failure to use this machine properly can lead to serious personal injury or death. Operators and maintenance personnel must always read this manual prior to operation or maintenance of this machine.**

**Save this manual at a designated place for reference when necessary. All personnel who work on this machine are to carry out periodic reference.**

- **Only those who have thorough understanding of the fundamental procedures provided in this manual are qualified to perform machine operation.**
- **Keep this manual handy for reference when necessary.**
- **Should you lose or damage this manual, contact Maeda or our sales service agency immediately for ordering a new manual.**
- **This manual should always accompany this machine upon transfer of the machine to the next owner.**
- **This manual has adopted data that was available at the time of the creation of the manual.**

**The contents of this manual, including maintenance specifications, tightening torque, pressure, measuring method, adjustment value, and illustrations, are subject to change upon unremitting refinement of the machine, without notice.**

**Machine maintenance may be susceptible to revisions. Always obtain the latest information from Maeda or our sales service agency before performing maintenance of this machine.**

**For safety instructions, see “2. For Safe Use of Machine” on page 1-3 and “Safety” on page 2-1.**

## 2. FOR SAFE USE OF MACHINE

This manual classifies the risks into the following three categories to present the details of the safety labels in easy-to-understand manner.



This denotes that there is an imminent hazard which will cause serious personal injury or death.

The method of hazard circumvention is stated.



This denotes that there is a hazard which can cause serious personal injury or death.

The method of hazard circumvention is stated.



This denotes that there is a potential hazard which may cause minor or moderate personal injury or serious damage to this machine.

The method of hazard circumvention is stated.

This manual also provides the following to indicate what must be observed for the sake of the machine and what will be of help.



This denotes that failure to handle the machine properly may damage the machine or shorten its life.



This denotes helpful information.

Not only procedures for operation, inspection, and maintenance of this machine described in this manual but also safety precautions should pertain to the case where this machine is only used for specified tasks. Every circumstance incidental to use of this machine is unforeseeable, and therefore, cautions given in this manual and on this machine do not necessarily cover every safety-related issue. Necessary safety actions should be taken under your responsibility if operation, inspection, and maintenance in a situation that is not described in this manual are performed. Even in the above case, never attempt the works and operations this manual prohibits you to do.

### 3. MACHINE OVERVIEW

#### 3.1 SPECIFIED OPERATIONS

This machine is to be used for operation listed below.

- Crane operation

This machine is a mobile crane with a rubber track traveling dolly (carrier) mounted with a boom crane. This self-propelled crane is capable of moving (traveling) in the worksite and craning an object weighing within the rated total load.

This is also a remote-controlled crane.

#### 3.2 MACHINE CONFIGURATION

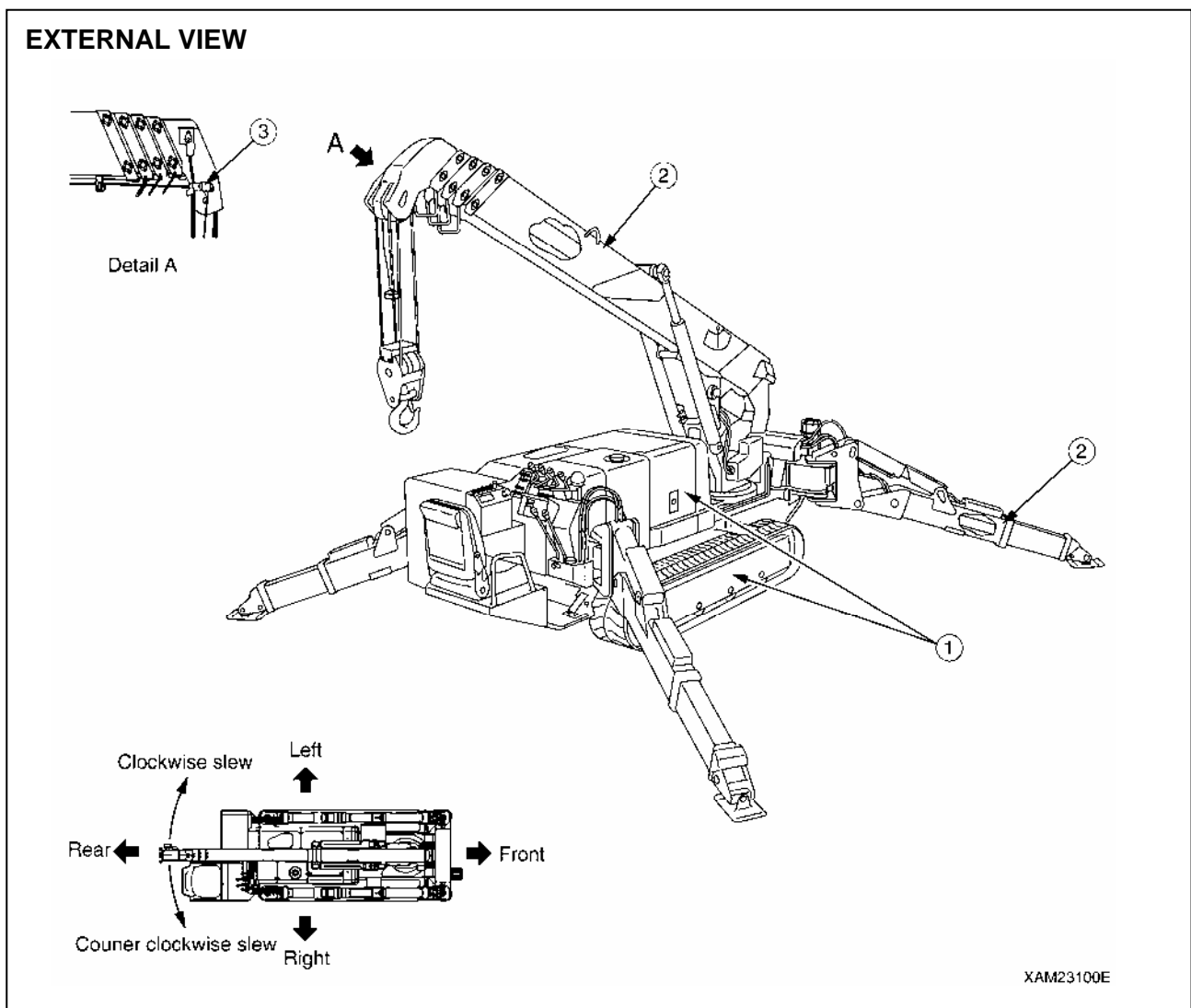

- (1) Traveling dolly
- (2) Crane
- (3) Safety device

Viewed from the operation seat, the front, back, left, and right of the machine are determined in this manual, viewing in the traveling direction (front) of the machine.

Boom slewing motion is determined with the machine viewed from immediately above; slew clockwise denotes right-handed motion and slew counterclockwise denotes left-handed motion.

This machine is composed of the units listed below.

### **[1] TRAVELING DOLLY**

This is composed of a traveling gear, engine, traveling operation unit, and crane operation unit.

### **[2] CRANE**

This is composed of a telescoping system, derrick system, hook block, winch system, and outrigger system.

### **[3] SAFETY DEVICE**

This is composed of the following parts and devices: Over hoist detector / automatic stop device, three-winding stop alarm / automatic stop device, load indicator, hydraulic safety valve, hydraulic automatic locking device, slinging rope detachment protector, alarm buzzer, audio alarm, level, crane tip-over alarm (an alarm issued in the event of the crane operation at 3-degree inclination and traveling at 15-degree inclination), traveling lever lock, traveling/crane/outrigger selector switch (designed to prevent the machine from craning at traveling), outrigger safety device (outrigger interlock and crane interlock), moment limiter (working envelope limited), working status lamp, outrigger non-installation warning lamp.

## **3.3 MACHINE FUNCTIONS**

### **[1] TRAVELING DOLLY**

- This is a compact machine designed to keep the overall width between the crane and outrigger minimized with them housed (in traveling position).  
This compact design is ideal for work in confined areas.
- Two-traveling lever operation enables not only direction changes among forward, backward, and right/left but pivot turn and spin turn.

### **[2] CRANE**

- An automatic slide outrigger is embedded in the crane to permit outrigger extension and grounding from the operation seat.
- Through the combined use of telescoping, derricking, and slewing besides winch system operation, the crane is capable of raising or lowering the hook block and moving an object weighing within the rated total load to a designated position within the confines of the working envelope.
- Remote-control units allow remote outrigger setting and remote crane operation.

## 4. QUALIFICATION FOR OPERATION

### **WARNING**

- **A high incidence of occupational accidents in crane operation has been reported. Be aware that experienced engineers are also no exception.**
- **Warnings and precautions defined in this manual shall be observed for safety assurance during operation of the machine.**

### 4.1 QUALIFICATION FOR CRANE OPERATION

Only personnel that have obtained the license stipulated by laws and regulations applicable to the place of use are qualified to operate this machine.

Contact the relevant government office or our sales service agency for further information.

## 5. TERMINOLOGY

### 5.1 DEFINITIONS OF TERMS

#### [1] RATED TOTAL LOAD

This is the maximum load that can be applied according to a boom length and angle. The load includes the mass (weight) of hoisting accessories (hooks) and slinging ropes.

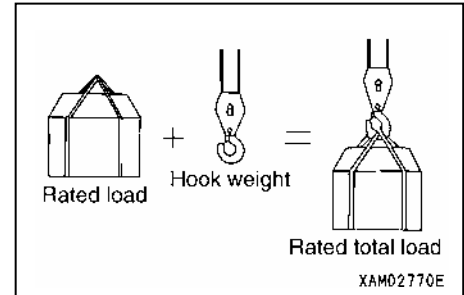

#### [2] RATED LOAD

This is a load derived by subtracting the mass (weight) of hoisting accessories (hooks) and slinging ropes from the rated total load, which is a withstand load for hoisting.

#### [3] WORKING RADIUS

This is a horizontal distance between the axis of slewing and the hook center.

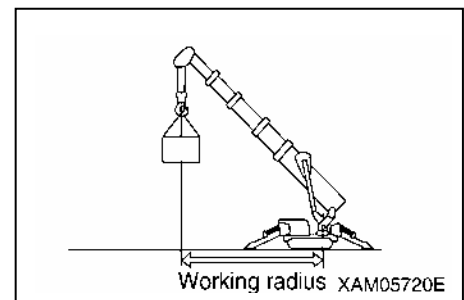

#### [4] BOOM LENGTH

This is a distance between the boom primary pin and the sheave pin of the end boom.

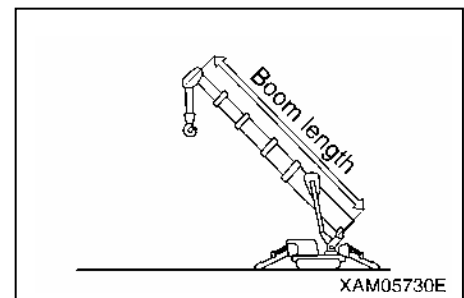

#### [5] BOOM ANGLE

This is an angle which the boom forms with the horizon.

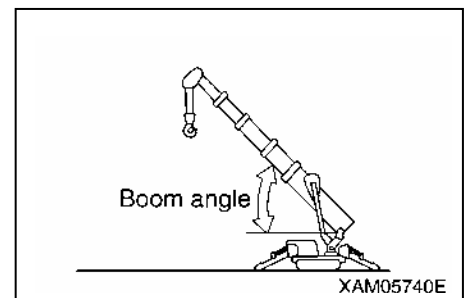

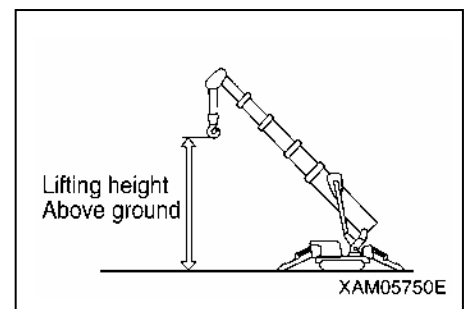

#### [6] LIFTING HEIGHT ABOVE GROUND

This is a vertical distance between the hook bottom and the ground with the hook raised until the upper limit.



## 5.2 DIAGRAM OF WORKING RADIUS AND LIFTING HEIGHT

### ⚠ WARNING

- The working radius/lifting height diagram indicates the relation between the working radius, boom angle and lifting height above ground of this machine, without any load suspended.
- “5.575m Boom” in the working radius/lifting height diagram shows the status where one half of first  mark is extended from the second stage boom.
- “7.075m Boom” in the working radius/lifting height diagram shows the status where one half of second  mark is extended from the second stage boom.

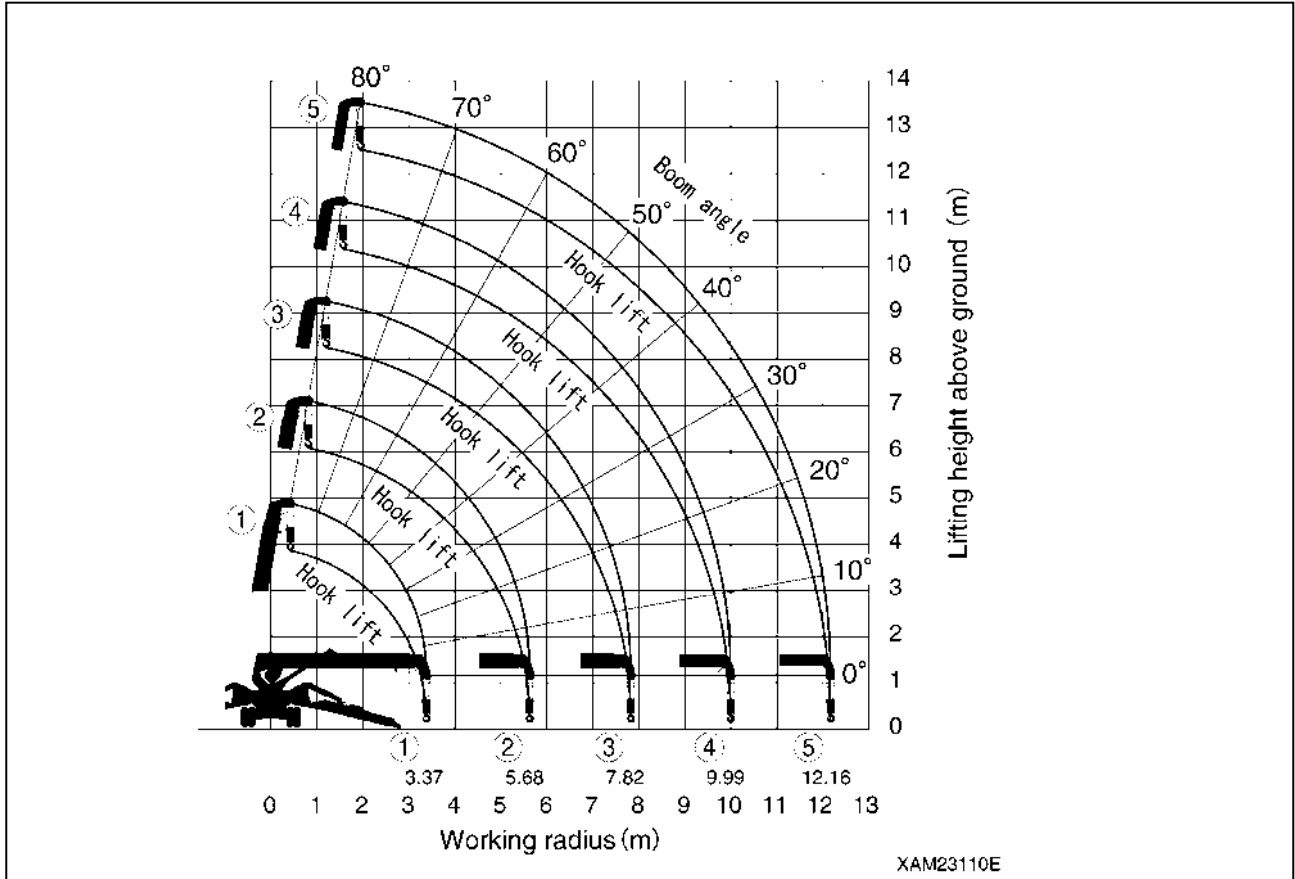

- Point A denotes a boom angle and point B denotes a lifting height above ground in the figure at right. The same working radius is applied to points A and B.

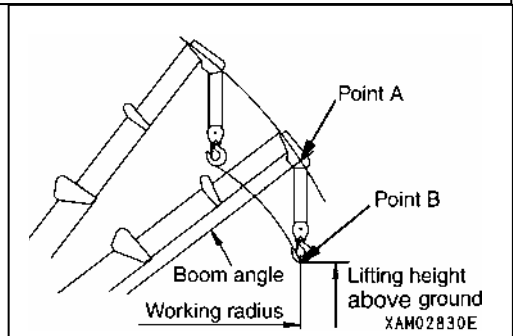

- The “diagram of working radius and lifting height” shows the relationships the working radius, boom angle, and lifting height at no load, allowing for no deflection in the boom. A deflection occurs in the boom when an object is hoisted, which causes the working radius to widen slightly. The rated total load decreases with increase in the working radius. Actual crane operation requires the planning of work, allowing for sufficient clearance more than that provided in the diagram.

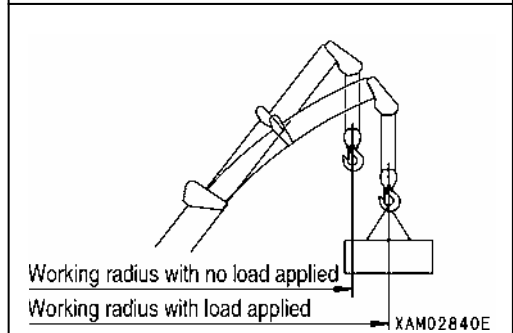

# 5.3 RATED TOTAL LOAD CHART

## ⚠ CAUTION

Rated total load chart is based on level, hard ground. Depending on the outrigger setting or ground conditions, machine may tip over.

Rated total load chart is based on working radius with bending of boom and lifted load taken into consideration.

If boom is extended to any extent, work should be performed within the capacity for "5.575m Boom".

When more than one half of the first mark is exposed from the boom (2), work should be carried out within the performance for the "7.075m Boom".

When more than one half of the second mark is exposed from boom (2), work should be carried out within the performance for the "8.575m Boom".

If working radius exceeds the value of Working Radius column in the chart by any extent, work should be performed within the rated total load in the next column of Working Radius.

Rated total load is shown with the mass of hook (20kg) included.

Unless outrigger is extended to maximum, work should be performed in accordance with the "Rated Total Load Chart without extending outrigger to maximum".

| With outrigger extended to maximum            |                     |  |      |      |      |      |      |      |                     | With outrigger extended to medium |  |  |  |      |      |      |      |      |       |     |     |     |     |
|---|---------------------|--|------|------|------|------|------|------|---------------------|-----------------------------------|--|--|--|------|------|------|------|------|-------|-----|-----|-----|-----|
|   |                     |  |      |      |      |      |      |      |                     |                                   |  |  |  |      |      |      |      |      |       |     |     |     |     |
| Crane work with outrigger extended to maximum | Boom 1 and Boom 1+2 |  |      |      |      |      |      |      |                     |                                   | Crane work with outrigger extended to medium | Boom 1 and Boom 1+2  |  |      |      |      |      |      |       |     |     |     |     |
|   | Working radius m    | 2.5  | 3.0  | 3.5  | 4.0  | 4.5  | 5.0  | 5.62 | Working radius m    | 2.5                               |  | 3.0  | 3.5  | 4.0  | 4.5  | 5.0  | 5.62 |      |       |     |     |     |     |
|   | Rated total load kg | 2980   | 2390 | 1990 | 1710 | 1490 | 1340 | 1160 | Rated total load kg | 2980                              |  | 2360   | 1960   | 1680 | 1380 | 1140 | 950  |      |       |     |     |     |     |
|   | Boom 1+2+3          | When boom 3 is extended to any extent whatsoever, the work should be carried out within the performance of boom configuration 1+2+3.         |      |      |      |      |      |      |                     |                                   |  | Boom 1+2+3   | When boom 3 is extended to any extent whatsoever, the work should be carried out within the performance of boom configuration 1+2+3.         |      |      |      |      |      |       |     |     |     |     |
|   | Working radius m    | 2.73   | 3.03 | 3.4  | 4.04 | 4.55 | 5.6  | 7.07 | 8.2                 | Working radius m                  |  | 2.73   | 3.03   | 3.4  | 4.04 | 4.55 | 5.6  | 7.07 | 8.2   |     |     |     |     |
|   | Rated total load kg | 2270   | 2120 | 1680 | 1440 | 1260 | 1110 | 990  | 880                 | 730                               |  | 630  | Rated total load kg  | 2270 | 2090 | 1680 | 1420 | 1240 | 1070  | 950 | 800 | 610 | 520 |
|   | Boom 1+2+3+4        | When boom 4 is extended to any extent whatsoever, the work should be carried out within the performance of boom configuration 1+2+3+4.       |      |      |      |      |      |      |                     |                                   |  | Boom 1+2+3+4   | When boom 4 is extended to any extent whatsoever, the work should be carried out within the performance of boom configuration 1+2+3+4.       |      |      |      |      |      |       |     |     |     |     |
|   | Working radius m    | 4.0  | 4.5  | 5.0  | 6.0  | 7.0  | 8.0  | 9.0  | 9.99                | Working radius m                  |  | 4.0  | 4.5  | 5.0  | 6.0  | 7.0  | 8.0  | 9.0  | 9.99  |     |     |     |     |
|   | Rated total load kg | 1080   | 985  | 880  | 770  | 670  | 570  | 500  | 435                 | Rated total load kg               |  | 1060   | 950  | 860  | 750  | 630  | 490  | 410  | 350   |     |     |     |     |
|   | Boom 1+2+3+4+5      | When more than half of mark 1 is exposed from boom 4, the work should be carried out within the performance of boom configuration 1+2+3+4+5. |      |      |      |      |      |      |                     |                                   |  | Boom 1+2+3+4+5   | When more than half of mark 1 is exposed from boom 4, the work should be carried out within the performance of boom configuration 1+2+3+4+5. |      |      |      |      |      |       |     |     |     |     |
| Working radius m                              | 4.5                 | 5.0  | 6.0  | 7.0  | 8.0  | 9.0  | 10.0 | 11.0 | 12.16               | Working radius m                  | 4.5  | 5.0  | 6.0  | 7.0  | 8.0  | 9.0  | 10.0 | 11.0 | 12.16 |     |     |     |     |
| Rated total load kg                           | 790                 | 660  | 520  | 430  | 380  | 340  | 310  | 280  | 260                 | Rated total load kg               | 780  | 650  | 500  | 410  | 360  | 320  | 290  | 260  | 250   |     |     |     |     |
| With outrigger extended to minimum            |                     |  |      |      |      |      |      |      |                     |                                   |  |  |  |      |      |      |      |      |       |     |     |     |     |
| Crane work with outrigger extended to minimum | Boom 1 and Boom 1+2 |  |      |      |      |      |      |      |                     |                                   | Boom 1 and Boom 1+2                          |  |  |      |      |      |      |      |       |     |     |     |     |
|   | Working radius m    | 2.5  | 3.0  | 3.5  | 4.0  | 4.5  | 5.0  | 5.62 | Working radius m    | 2.5                               | 3.0  | 3.5  | 4.0  | 4.5  | 5.0  | 5.62 |      |      |       |     |     |     |     |
|   | Rated total load kg | 2980   | 2350 | 1800 | 1430 | 1140 | 950  | 790  | Rated total load kg | 2980                              | 2350   | 1800   | 1430   | 1140 | 950  | 790  |      |      |       |     |     |     |     |
|   | Boom 1+2+3          | When boom 3 is extended to any extent whatsoever, the work should be carried out within the performance of boom configuration 1+2+3.         |      |      |      |      |      |      |                     |                                   | Boom 1+2+3                                   | When boom 3 is extended to any extent whatsoever, the work should be carried out within the performance of boom configuration 1+2+3.         |  |      |      |      |      |      |       |     |     |     |     |
|   | Working radius m    | 2.73   | 3.03 | 3.4  | 4.04 | 4.55 | 5.6  | 7.07 | 8.2                 | Working radius m                  | 2.73   | 3.03   | 3.4  | 4.04 | 4.55 | 5.6  | 7.07 | 8.2  |       |     |     |     |     |
|   | Rated total load kg | 2270   | 2090 | 1680 | 1370 | 1160 | 910  | 790  | 670                 | 510                               | 430  | Rated total load kg  | 2270   | 2090 | 1680 | 1370 | 1160 | 910  | 790   | 670 | 510 | 430 |     |
|   | Boom 1+2+3+4        | When boom 4 is extended to any extent whatsoever, the work should be carried out within the performance of boom configuration 1+2+3+4.       |      |      |      |      |      |      |                     |                                   | Boom 1+2+3+4                                 | When boom 4 is extended to any extent whatsoever, the work should be carried out within the performance of boom configuration 1+2+3+4.       |  |      |      |      |      |      |       |     |     |     |     |
|   | Working radius m    | 4.0  | 4.5  | 5.0  | 6.0  | 7.0  | 8.0  | 9.0  | 9.99                | Working radius m                  | 4.0  | 4.5  | 5.0  | 6.0  | 7.0  | 8.0  | 9.0  | 9.99 |       |     |     |     |     |
|   | Rated total load kg | 1060   | 950  | 860  | 680  | 530  | 420  | 340  | 300                 | Rated total load kg               | 1060   | 950  | 860  | 680  | 530  | 420  | 340  | 300  |       |     |     |     |     |
|   | Boom 1+2+3+4+5      | When more than half of mark 1 is exposed from boom 4, the work should be carried out within the performance of boom configuration 1+2+3+4+5. |      |      |      |      |      |      |                     |                                   | Boom 1+2+3+4+5                               | When more than half of mark 1 is exposed from boom 4, the work should be carried out within the performance of boom configuration 1+2+3+4+5. |  |      |      |      |      |      |       |     |     |     |     |
| Working radius m                              | 4.5                 | 5.0  | 6.0  | 7.0  | 8.0  | 9.0  | 10.0 | 11.0 | 12.16               | Working radius m                  | 4.5  | 5.0  | 6.0  | 7.0  | 8.0  | 9.0  | 10.0 | 11.0 | 12.16 |     |     |     |     |
| Rated total load kg                           | 780                 | 650  | 500  | 410  | 360  | 320  | 290  | 240  | 210                 | Rated total load kg               | 780  | 650  | 500  | 410  | 360  | 320  | 290  | 240  | 210   |     |     |     |     |

XAM23120E



The rated total load chart provides the maximum loads that the crane is capable of hoisting objects in parallel with the length of the boom. The loads are specified by working radius.

### [1] BOOM LENGTH

The following figures illustrate the condition of the booms, "Boom (1)", "Boom (1) + (2)", "Boom (1) + (2) + (3)", "Boom (1) + (2) + (3) + (4)", and "Boom (1) + (2) + (3) + (4) +(5)" in the preceding boxes in the rated total load chart.

1. "Boom (1)": All the booms are retracted.



2. "Boom (1) + (2)": With booms (3), (4), and (5) retracted, boom (2) is fully extended.

"Boom (1) + (2)" is to apply to crane operation with boom (2) extended even if only slightly.

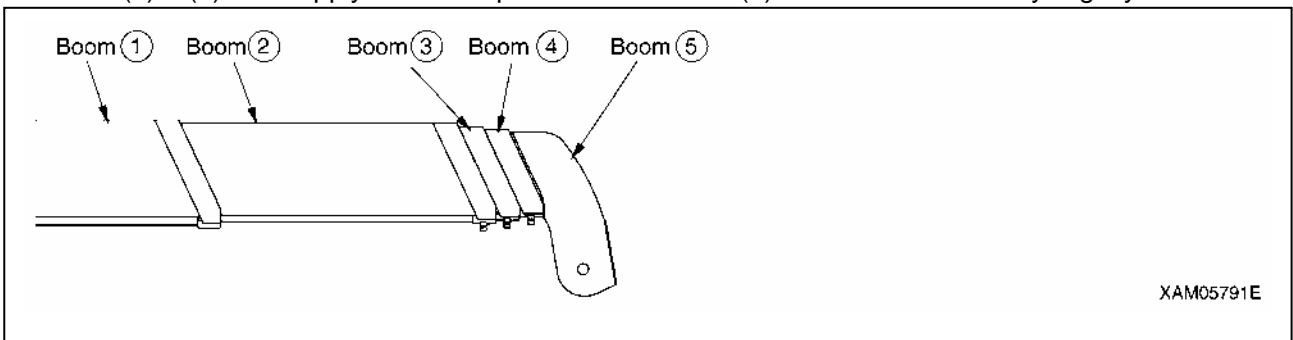

3. "Boom (1) + (2) + (3)": With booms (4) and (5) retracted, booms (2) and (3) are fully extended.

"Boom (1) + (2) + (3)" is to apply to crane operation with boom (3) extended even if only slightly.

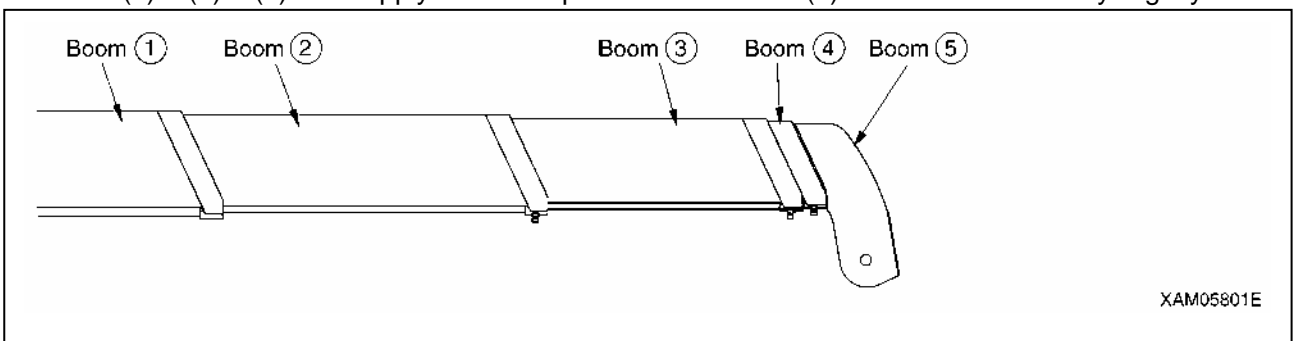

4. "Boom (1) + (2) + (3) + (4)": With booms (2) and (3) fully extended, booms (4) and (5) are extended midway (half of the "▀" mark" passes boom (3)).  
"Boom (1) + (2) + (3) + (4)" is to apply to crane operation with booms (4) and (5) extended even if only slightly.

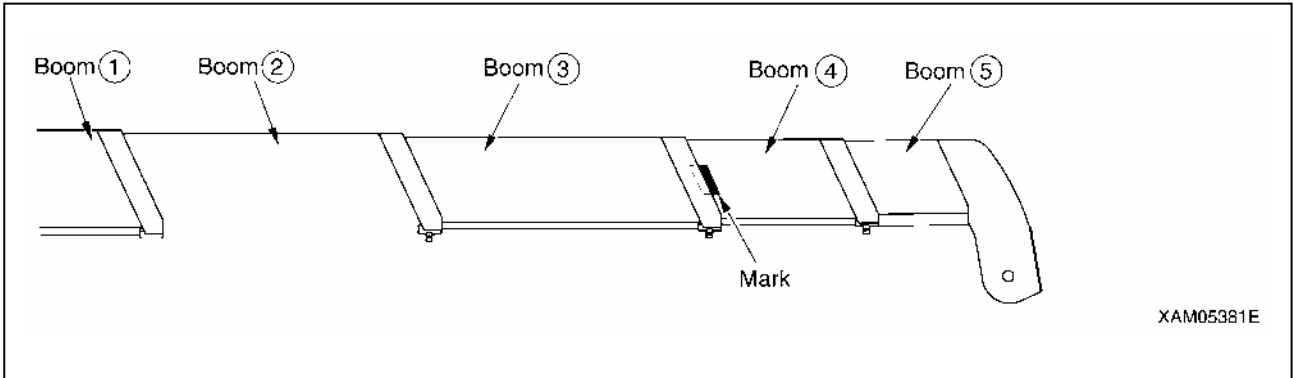

5. "Boom (1) + (2) + (3) + (4) + (5)": All the booms are fully extended.  
"Boom (1) + (2) + (3) + (4) + (5)" is to apply to crane operation with half of the "▀" mark" on boom (4) passes boom (3).

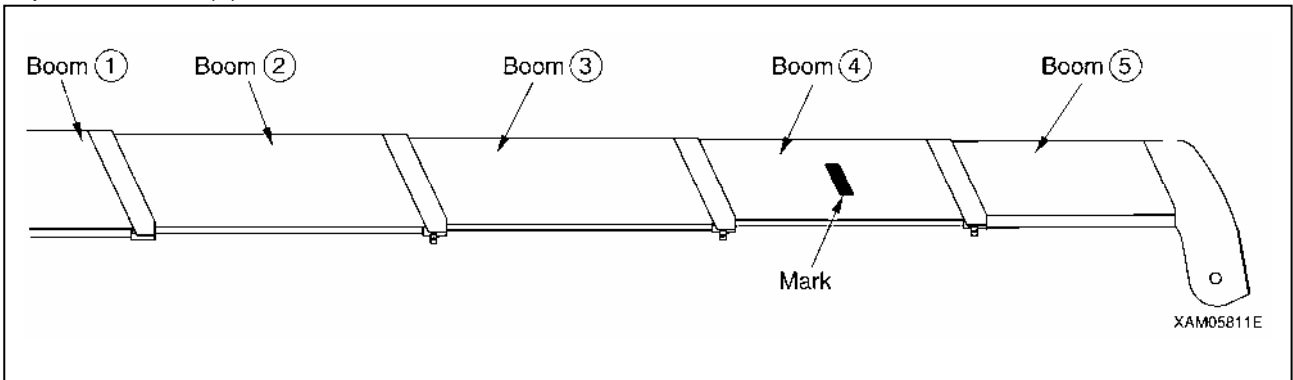

## [2] OUTRIGGER MAXIMUM EXTENSION

### ⚠ WARNING

- Make sure all the outriggers are placed properly before performing crane operation. This machine features a safety-interlock system that prevents crane operation unless all the lamps, other than the boom retraction lamp on the outrigger monitor, are on.
- Always place the machine in a horizontal position with the use of the level when extending the outriggers. A warning buzzer sounds when the machine is inclined 3° or more and stops when the machine is placed in a horizontal position.
- When the crane is used with the outriggers extended other than at the maximum, crane operation should proceed with respect to the values specified in the rated total load chart corresponding to “When the crane is used with the outriggers extended at the minimum/midway”.

Failure to perform crane operation with proper values may cause the machine to topple over. Exercise caution when performing operation.

- Despite the maximum extension of all the outriggers, the width of extended outriggers decreases due to an ungraded ground even when clearance "a" in the right figure is 50 mm.

Crane operation should proceed with respect to the values specified in “When the crane is used with the outriggers extended midway” in the rated total load chart.

- The machine becomes unsteady at some point if it undergoes a 360-degree slewing with an object hoisted. Irrespective of the rated total load, ensure operation in a short working radius and at low speed.

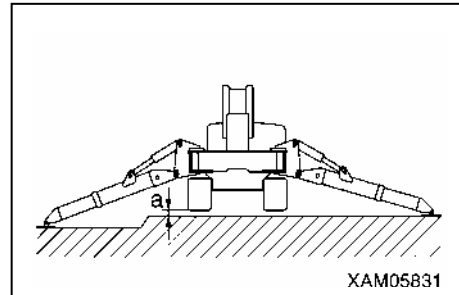

The figure shown at right represents the condition “When the crane is used with the outriggers extended at the maximum” in the rated total load chart.

Ensure that all the lamps, other than the boom retraction lamp on the outrigger monitor, are on.

If the inner box is retracted even if only slightly, crane operation should proceed with respect to the values specified in the rated total load chart corresponding to “When the crane is used with the outriggers extended at the minimum/midway”.

See "OPERATION 2.14 OUTRIGGER SETTING OPERATION" for proper setting of the outriggers.

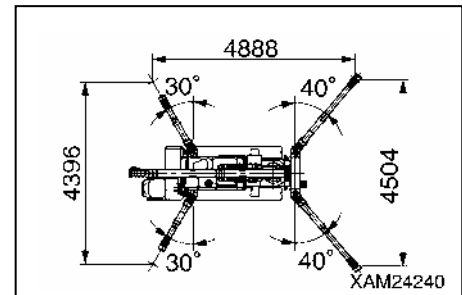

### NOTES

Outrigger maximum extension is defined as that:

1. The outrigger is set at the positioning pin position (40° front, 30° back).
2. The inner box of all the outriggers is extended fully.
3. All the outriggers are placed on a level surface.
4. Approx. 50mm is assured for clearance "a" (between the outrigger bottom and crawler bottom) in the figure at right.

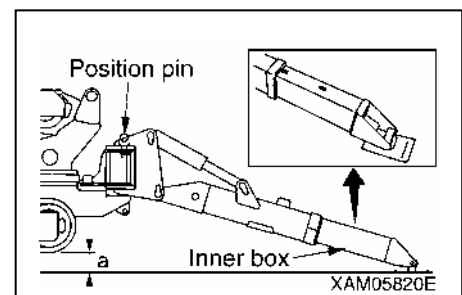

### [3] OUTRIGGER MIDWAY EXTENSION

#### ⚠ WARNING

- Make sure all the outriggers are placed properly before performing crane operation. This machine features a safety-interlock system that prevents crane operation unless all the lamps, other than the boom retraction lamp on the outrigger monitor, are on.
- Always place the machine in a horizontal position with the use of the level when extending the outriggers. A warning buzzer sounds when the machine is inclined 3° or more and stops when the machine is placed in a horizontal position.
- When the crane is used with the outriggers extended other than at the maximum, crane operation should proceed with respect to the values specified in the rated total load chart corresponding to “When the crane is used with the outriggers extended at the minimum/midway”.

Failure to perform crane operation with proper values may cause the machine to topple over. Exercise caution when performing operation.

- Despite the midway extension of all the outriggers, the width of extended outriggers decreases due to an ungraded ground even when clearance "a" in the right figure is 50 mm.

Crane operation should proceed with respect to the values specified in “When the crane is used with the outriggers extended at the minimum” in the rated total load chart.

- The machine becomes unsteady at some point if it undergoes a 360-degree slewing with an object hoisted. Irrespective of the rated total load, ensure operation in a short working radius and at low speed.

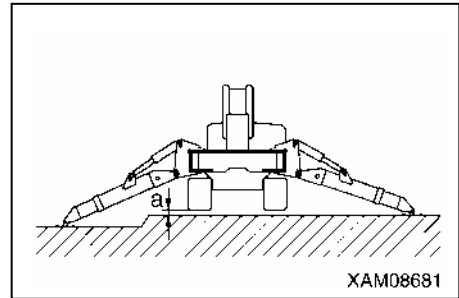

The figure shown at right represents the condition “When the crane is used with the outriggers extended midway” in the rated total load chart.

#### NOTES

Outrigger midway extension is defined as that:

1. The outrigger is set at the positioning pin position (40° front, 30° back).
2. The inner box of all the outriggers is extended midway.
3. All the outriggers are placed on a level surface.
4. Approx. 50mm is assured for clearance “a” (between the outrigger bottom and crawler bottom) in the figure at right.

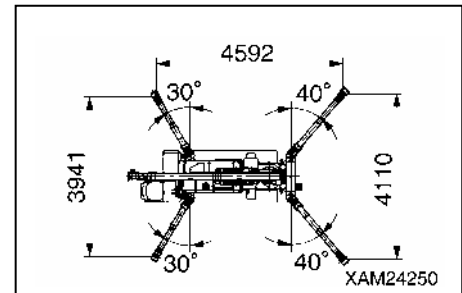

#### NOTES

If even a group of outriggers is retracted to a midway point, all the outriggers are deemed to be extended midway.

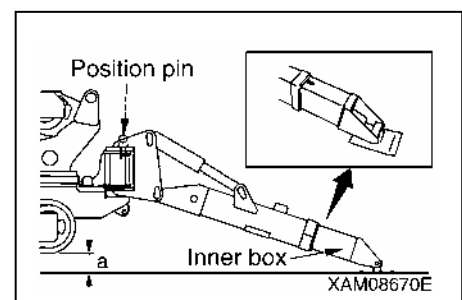

**[4] OUTRIGGER MINIMUM EXTENSION**

**⚠ WARNING**

- Make sure all the outriggers are extended before performing crane operation. Crane operation is allowed only when all the outriggers are placed properly. Potential overturning of the machine may occur that leads to serious personal injury if disregarded.
- Always place the machine in a horizontal position with the use of the level when extending the outriggers.  
A warning buzzer sounds when the machine is inclined 3° or more and stops when the machine is placed in a horizontal position.
- When the crane is used with the outriggers extended other than at the maximum, crane operation should proceed with respect to the values specified in the rated total load chart corresponding to “When the crane is used with the outriggers extended at the minimum/midway”. Failure to perform crane operation with proper values may cause the machine to topple over. Exercise caution when performing operation.
- Crane operation with the outriggers extended at the minimum is permitted only if the outriggers are placed on a level surface. 50mm of dimension between the outrigger bottom and crawler bottom should be obtained.
- On ungraded ground or similar, the width of extended outriggers decreases even when clearance "a" in the right figure is 50 mm. Do not perform crane operation under such extension condition. Potential overturning of the machine may occur that leads to serious personal injury if disregarded.
- The machine becomes unsteady at some point if it undergoes a 360-degree slewing with an object hoisted. Irrespective of the rated total load, ensure operation in a short working radius and at low speed.

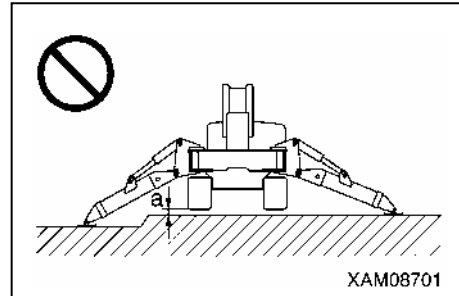

The figure shown at right represents the condition “When the crane is used with the outriggers extended at the minimum” in the rated total load chart.

**NOTES**

Outrigger minimum extension is defined as that:

1. The outrigger is set at the positioning pin position (40° front, 30° back).
2. The inner box of all the outriggers is minimized.
3. All the outriggers are placed on a level surface.
4. Approx. 50mm is assured for clearance "a" (between the outrigger bottom and crawler bottom) in the figure at right.

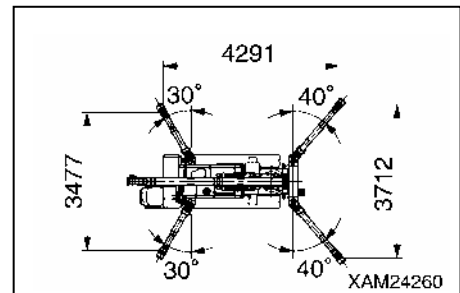

**NOTES**

If even a group of outriggers is retracted to the minimum point, all the outriggers are deemed to be extended at the minimum.

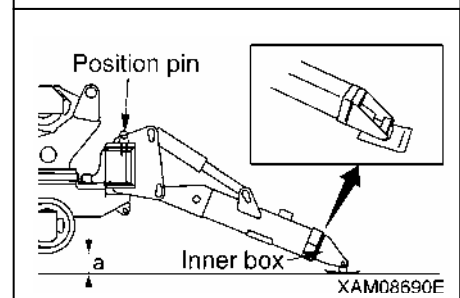

## 5.4 LOAD INDICATOR

### **⚠ WARNING**

- The following precautions should always be observed when reading the “rated total load” provided by the load indicator. Potential overturning or damage to the machine may occur that leads to a serious accident if disregarded.
  1. The outriggers should be placed on a level and firm surface.
  2. The outriggers should be extended at the maximum.
- The weight of an object including that of a hoisting accessory and slinging rope must remain below the rated total load for hoisting objects. With the boom length (number of stages) and angle specified, make a comparison between the rated total load provided by the load indicator and the weight of the object.
- The rated total loads provided by the load indicator are not available if the outriggers are not extended at the maximum.  
Only read the “boom angle” on the load indicator.

The load indicator, composed of a “pointer” and “scale plate” as shown at right, is attached to both sides of boom 1.

The load indicator shown at right provides readouts on the rated total load under the following conditions: that the outriggers are placed on a level and firm surface, that the outriggers are extended fully (see section 5.3 “[2] Outrigger maximum extension” in Introduction), and that no deflection is developed in the boom.

How to read the load indicator:

- Read an intersection point of the scale plate and the pointer of the boom.

The value read is a rated total load on the relevant boom.

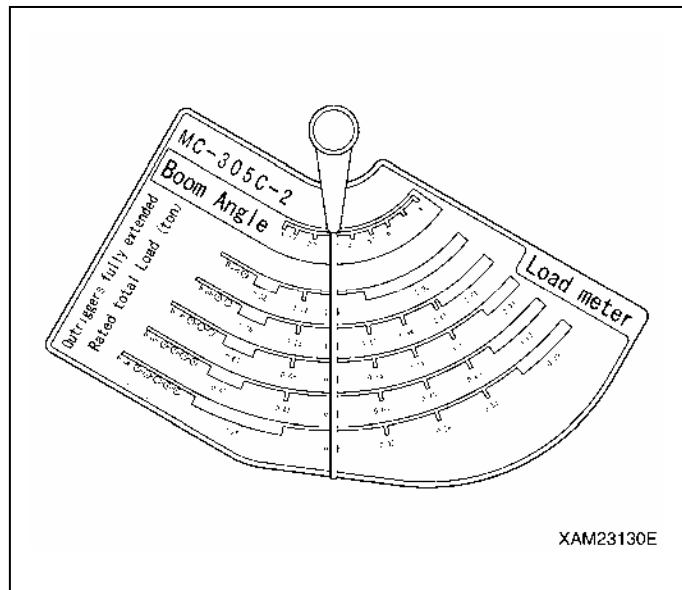

[An example of observation]

**⚠ WARNING**

- The following precautions should always be observed when reading the "rated total load" provided by the load indicator. Potential overturning or damage to the machine may occur that leads to a serious accident if disregarded.
  1. The outriggers should be placed on a level and firm surface.
  2. The outriggers should be extended at the maximum.
- The rated total loads provided by the load indicator are not available if the outriggers are not extended at the maximum.
 

Only read the "boom angle" on the load indicator.

This explanation of the observation assumes the case when the load indicator is showing the following condition.

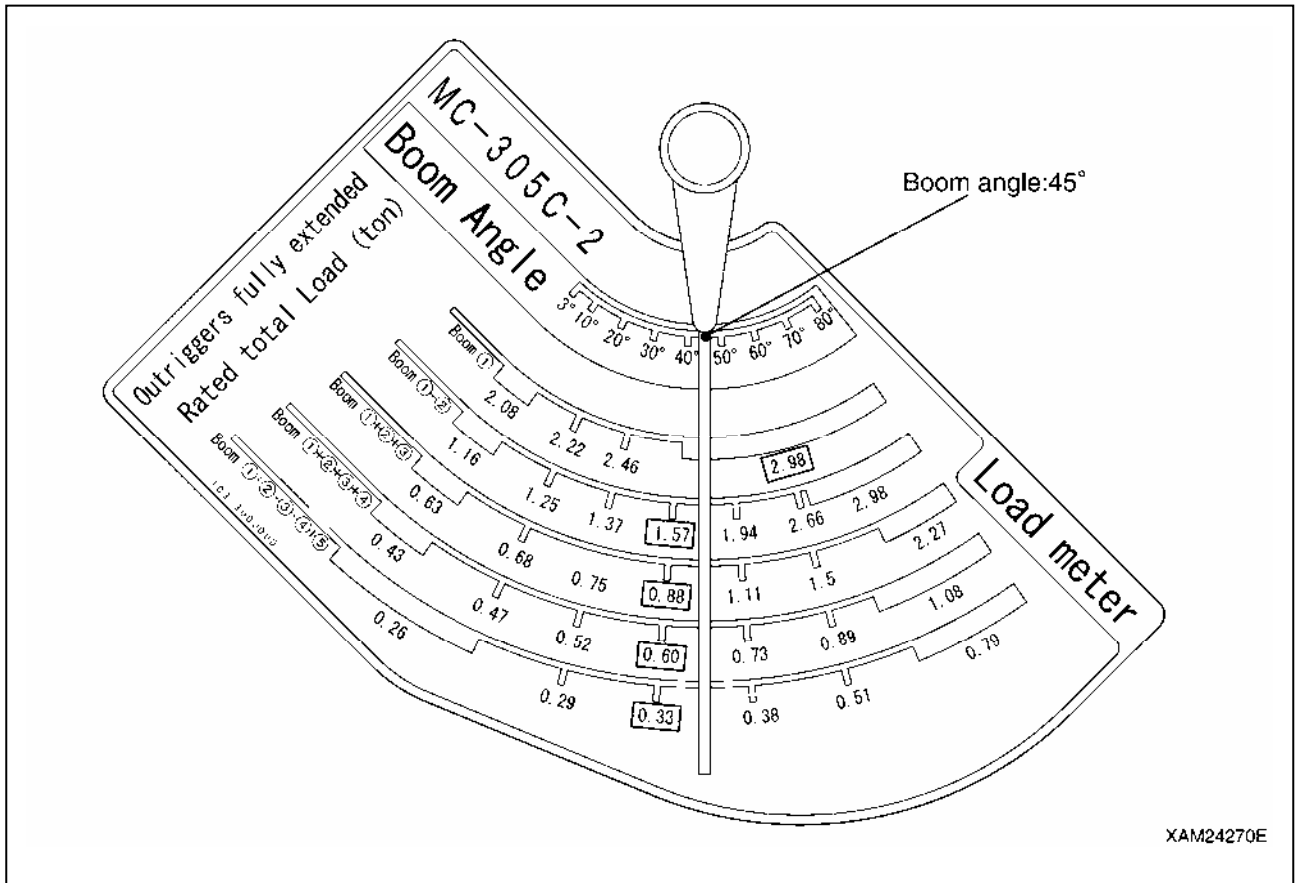

1. Boom angle
 

The boom angle is approximately 45 degrees.
2. Rated total load when outriggers are fully extended
  - 2.98 t if boom (1).
  - 1.57 t if booms (1) + (2).
  - 0.88 t if booms (1) + (2) + (3).
  - 0.60 t if booms (1) + (2) + (3) + (4).
  - 0.33 t if booms (1) + (2) + (3) + (4) + (5).

# SAFETY

|                                   |      |
|-----------------------------------|------|
| 1. BASIC PRECAUTIONS              | 2- 2 |
| 2. DRIVING RELATED PRECAUTIONS    | 2- 7 |
| 3. TRANSPORT PRECAUTIONS          | 2-21 |
| 4. BATTERY HANDLING PRECAUTIONS   | 2-23 |
| 5. MAINTENANCE PRECAUTIONS        | 2-25 |
| 6. SAFETY LABEL LOCATIONS         | 2-32 |
| 7. WEEE DIRECTIVE LABEL LOCATIONS | 2-42 |

## WARNING

All the safety precautions defined in this manual should always be read and observed.

Failure to follow the safety precautions can cause serious personal injury or death.

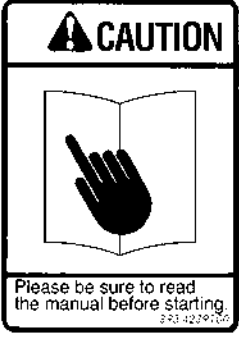

# 1. BASIC PRECAUTIONS

| OBSERVE THE MANUAL AND SAFETY LABELS   |   |
|--|---|
| <ul style="list-style-type: none"><li>• Read well and understand this manual as well as the safety labels labeled on various part of this Machine. Attempt to drive/operate without understanding fully may result in wrong operation that may cause personal or equipment accidents.</li><li>• Fully understand the proper use and inspection/maintenance procedures, and exercise safe works.</li><li>• Make sure this manual and the safety labels labeled on various part of this Machine are legible all the time. Whenever illegibility or loss occurs, order us or our sales service agency and put the safety label back to the original location.</li></ul> |  |

| DRIVING LICENSE  |
|--|
| <ul style="list-style-type: none"><li>• Licenses are necessary to drive this Machine. Always obtain licenses before driving. ★See “Introduction 4. Qualification for Operation” for details</li><li>• The drivers are requested to receive educations and training of the handling methods and other subjects in the applicable office, and obtain sufficient driving operation skill before work.</li></ul> |

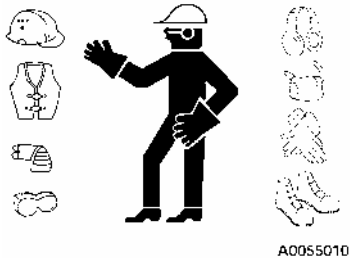
| WEAR PROTECTIVE EQUIPMENT AND CLOTHES SUITABLE FOR WORK  |   |
|--|---|
| <ul style="list-style-type: none"><li>• Always put on a helmet, safety shoes and safety belt.</li><li>• Select and make sure to put on necessary protective equipment suitable for the relevant working condition.</li><li>• Do not wear loose garment or accessory item that may catch operation lever or protrusions and cause unexpected movement of the Machine.</li></ul> |  |

| COMMIT TO SAFE OPERATION   |
|--|
| <ul style="list-style-type: none"><li>• Obey the instructions and signs given by the manager and work supervisor, and observe safety first during the work.</li><li>• Obey the crane work basics during work.</li><li>• Before starting driving or a work, always carry out the inspections before work.</li><li>• Do not work under bad weather for instance strong wind, thunder or mist.</li><li>• Do not drive under any condition when you are overtired, dosed with alcohol or after taking a somnific drug.</li><li>• Obey all of the workplace rules, safety regulations and operation method sequences during driving operations and inspection/maintenance.</li><li>• Pay attention to surrounding conditions and pedestrians all the time when driving or working. Whenever pedestrian approaches unwarily, abort working once, and take a measure such as issuing a warning.</li><li>• When driving, be mentally prepared for unexpected situation and so that you can take measures immediately.</li><li>• Do not attempt any use out of the capabilities and purposes described in this manual under any circumstance.</li><li>• Observe the designated rated total load and work range when driving.</li><li>• Do not attempt inattentive driving, harsh driving or awkward operation under any circumstance.</li><li>• Pull out the key when leaving operation seat.</li></ul> |

## USE OF MACHINE THAT WAS RENTED OR PREVIOUSLY USED BY SOMEONE ELSE

Check the following subjects on writing before using any Machine that was rented or previously used by someone else.

In addition, check the inspection record table for the maintenance conditions such as the periodic inspections.

- (1) Crane capacity
- (2) Crane maintenance condition
- (3) Behavior and disadvantage unique to the crane
- (4) Other subjects that require attention when driving
  - (a) operating condition of the brakes, crutches and others
  - (b) Presence/absence and lighting condition checkup of lightings and rotating lamps
  - (c) Operation condition of hook, winches, boom, outriggers and related

## PROVIDE SAFETY DEVICES FOR SURE

- Check that all guards and covers are attached properly. Repair immediately if damaged.
- Understand how to use the safety devices well and use properly.
- Do not detach any safety device under any circumstance. Keep control to achieve proper function all the time.
- Improper use of safety device leads to serious bodily accidents.
- Do not trust safety device too much to operate.

## FOLLOW INSTRUCTIONS AND SIGNS WHEN WORKING

- When working with the crane, appoint a work supervisor and mutual signs beforehand, and follow the work supervisor and signs during work.
- When working at a location where many parts are unsealed from the driver, be especially careful to follow the instructions and signs of the work supervisor and pay attention when driving.
- When working with the crane, the clearance between the boom and the traveling dolly and also the gaps between the movable parts of the derrick cylinder may catch body parts such as an arm or finger. The driver is requested to make sure no one is within the working radius of the crane before operating crane.

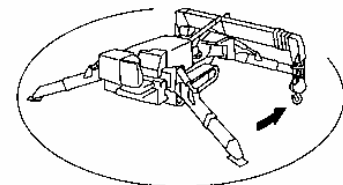

XAM05500



A0055130

## PREPARE FOR ABNORMALITY

- Carry out secure inspections and services, and be careful to prevent accident before happening.
- Whenever you feel abnormality of the Machine, abort working immediately, ensure safety and report to the manager.
- Assign in advance who takes which solution to prevent secondary accident.
- Do not drive the Machine when fuel or hydraulic oil is leaking from the Machine. Report the manager what is the abnormality, and fully repair the fuel/hydraulic oil before use.  
The fuel for this Machine is light petroleum. Be especially careful for presence of fuel leak.
- Before leaving the Machine, lower the hoisted load to the ground, stop the engine and pull out the engine key.



A0055020

## TEMPORARY STORAGE WHEN ABNORMALITY IS FOUND WITH MACHINE

In case the Machine is found with abnormality and is therefore stored temporarily waiting for service, apply following measures to notify all persons in the office that the use is prohibited due to failure.

- Indicate warning tags on the crane operation lever and other applicable parts.

Write clearly the information such as abnormality contents, name and contact of the storage manager, and the term of storage.

- Keep immovable when parking by for instance putting the blocks on the rubber tracks as pawls.
- Pull out the engine key and bring with you.

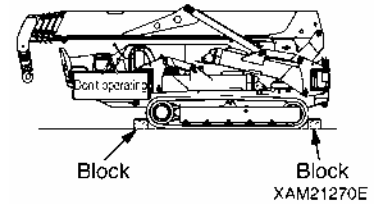

## PROVISION OF FIRE EXTINGUISHER AND FIRST AID BOX

Always observe followings to prepare for injuries and fires.

- To prepare for fires, decide the fire extinguisher storage location and install one, fully read the attached label for the usage and be prepared for fighting against the emergencies.
- Decide the location to store the first aid box. In addition, inspect the first aid box periodically and replenish the contents as necessary.
- Decide the measures to take upon an injury or fire accident.
- Decide how to contact the emergency address (for instance the emergency physician, ambulance or fire department), and show the contact address at designated position so any person can make the contact.

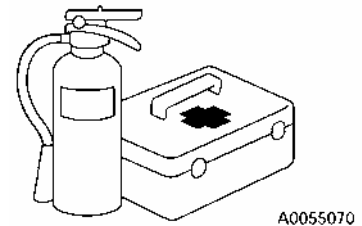

## DO NOT RUSH AND BE CAREFUL WHEN WORKING

- Do not attempt sudden lever operation or harsh driving.
- When two or more cranes work close to each other, drive carefully while paying attention to accidents such as trips caused by contacting each other. Also, appoint a guide if necessary for increased prevention of contact accidents.
- When abnormality or danger occurs during work, abort working immediately to avoid hazard.
- Abort the work under bad weather (heavy rain, strong wind, thunder, thick fog).

Decide whether to abort working by seeing the "work abort decision standard" in the work schedule and by discretion of the work supervisor of the site.

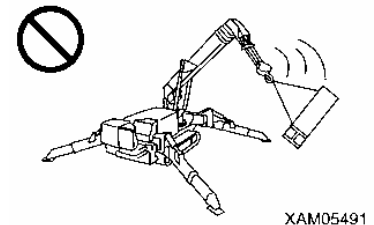

## DO NOT MODIFY

Do not modify the Machine without our written consent under any circumstance.

The modification raises a safety issue, so consult us or our sales service agency beforehand.

We cannot be held responsible for any bodily accident or failure caused by modification that was performed without consulting us.

## SAFETY WHEN REFILLING FUEL

- Light petroleum is used as the fuel of this Machine.  
Do not refill wrong kind of fuel.  
Refilling wrong oil may damage the engine.
- Always stop the engine before refilling fuel.  
Refilling the oil when engine is driving may cause leaked fuel to draw fire from hot muffler or other substance.
- Oversupply of oil results in spilling and is dangerous. Refill slightly fewer than the specified level.  
Always wipe away cleanly whenever the fuel spills.
- Securely close the tank cap after replenishing fuel.



A0055020



A0055040

## KEEP FIRE AWAY FROM OIL

Attempt to let a fire approach the fuel, hydraulic oil or engine oil may result in catching fire. Strictly observe the followings.

- Do not let any fire such as a cigarette or match approach combustibles.
- Securely close all of the fuel and oil container caps.
- Keep the fuel and oils in well-ventilated location.
- Store the fuel and oils in a fixed location and keep unrelated persons away.
- Do not leave the site when replenishing the fuel or oil.  
Be especially careful to observe "Safety when refilling fuel" described earlier when replenishing oil.
- Cleanly wipe away fuel and oil that spilled during replenishment.



A0055020



A0055040

## HANDLING HIGH TEMPERATURE

During short time after stopping operation of the Machine, the engine itself and engine oil, cooling water and hydraulic oil are in high temperature, and in addition the pressure is accumulated inside the hydraulic oil tank.

Attempt to inspect the engine, remove the radiator cap, drain oil, drain water or replace the filter under such condition may result in burns.

Wait until the temperature drops, then follow the following sequences.

- To prevent emission of the high temperature oil, stop the engine and wait until the oil temperature drops, and when loosening the cap, turn slowly and relieve the pressure before detaching the cap.  
(To find how much the oil temperature dropped, let your hand approach the surface of the hydraulic oil tank or similar location without actually contacting and find out from the ambient temperature.)



A0055050

## BEWARE OF ASBESTOS DUST

Inhalation air containing asbestos may result in lung cancer. This Machine does not use any asbestos, but asbestos may be contained in the wall, ceiling or other part of construction within the work area of this Machine. In addition, be careful of the followings when working with a material that may be using asbestos.

- Put on designated dust free mask and/or other equipment as necessary.
- Do not use compressed air for cleaning.
- Spray water when cleaning to prevent asbestos dusts from flying into air.
- Always work at windward location when driving the Machine at a site that may contain asbestos dusts.
- Strictly observe the assigned rules related to the working site and environmental standard.

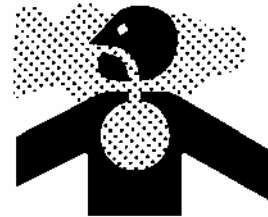

A0055060

## CRANE INJURY PREVENTION

Do not let whole or part of your body enter any of the following clearances, since such act may cause serious bodily accidents.

- Between the boom and the traveling dolly.
- Between the outrigger support and the ground contact surface.
- Between the boom/post and the derrick cylinder.
- Between the winch drum and the wire ropes.
- Between sheaves and wire rope.
- Between the crawlers and the ground.



A0055130

## BEWARE OF EXHAUST GAS

When starting the engine or handling fuel/cleaning oil/paint indoors or at a location with bad ventilation condition, prevent gas-poisoning risk by improving the ventilation by opening the windows and exits. If the ventilation is insufficient even after opening the windows and exits, set up a ventilation fan.



A0055060

## 2. DRIVING RELATED PRECAUTIONS

### 2.1 BEFORE STARTING ENGINE

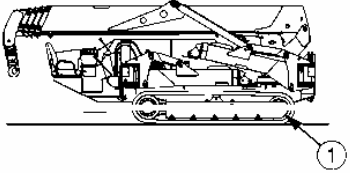
| <b>ESTABLISH SAFETY OF WORKING SITE</b>   |   |
|---|---|
| <ul style="list-style-type: none"> <li>• Confirm that no danger is present at the working site before starting work.</li> <li>• Investigate the ground and road surface condition of the working site and decide the best working method.</li> <li>• Flatten the inclination of the working site as much as possible before starting work. Also, if sands and gravels are excessive, spray water before work.</li> <li>• When working over the roadway, enforce keep out by for instance placing guides or surrounding by barriers, and ensure the safety of the traffic vehicles and pedestrians.</li> <li>• Enforce keep out to prevent people from entering the working site and apply measures to prevent people from approaching. Attempt to approach moving Machine may result in hard collision by contact or pinching, and may result in serious bodily accidents and deaths.</li> <li>• When traveling in the water or crossing over shallow water, check the ground condition, depth and water velocity beforehand and make sure not to exceed the allowable water depth (no higher than center of idler (1)).</li> </ul> <p>★ See “Operation 2.12 [2] Allowable Water Depth” for details</p> |  <p style="text-align: right; margin-top: 5px;">XAM22770</p> |

| <b>INSPECTION BEFORE STARTING ENGINE</b>  |   |
|---|---|
| <p>Execute following inspections before the first engine startup of the day.</p> <p>Omitting these inspections may result in serious bodily accidents.</p> <ul style="list-style-type: none"> <li>• Inspect for the fuel/oil leak, accumulation of combustibles around the engine and battery systems, and similar phenomenon.</li> </ul> <p>★ See “Operation 2.1 Checking Before Operation” for details.</p> <ul style="list-style-type: none"> <li>• Inspect the fuel quantity, cooling water quantity, hydraulic oil tank quantity, air cleaner blockage, electrical wiring damage, and check operations of safety devices and instruments.</li> </ul> <p>★ See “Operation 2.1 Checking Before Operation” for details.</p> <ul style="list-style-type: none"> <li>• Make sure the operation levers are at neutral position. Check that the operation linkages operate adequately. Always repair if any result of the above is faulty.</li> </ul> |  <p style="text-align: right; margin-top: 5px;">A0055020</p> |

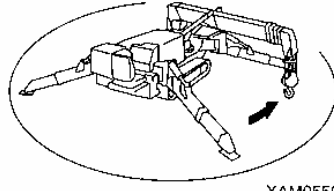
| <b>CAUTIONS WHEN STARTING ENGINE</b>   |   |
|--|---|
| <ul style="list-style-type: none"> <li>• Make sure no person or object is within the boom swing radius area before starting engine.</li> <li>• Blow the horn for warning before starting the engine.</li> <li>• Do not start the engine by short-circuiting the starter circuit. Such may cause a fire.</li> </ul> |  <p style="text-align: right; margin-top: 5px;">XAM05500</p> |

## 2.2 AFTER STARTING ENGINE

### INSPECTION AFTER STARTING ENGINE

Omitting the inspections after starting the engine results in delay to notice the Machine abnormalities, and may result in bodily accidents and Machine damages.

Execute inspection in a wide location with no obstacle. In addition, be sure to prevent people from approaching nearby the Machine.

- Inspect the equipment operation conditions, Machine traveling conditions, outrigger operation conditions, winch winding up and down, boom derricking, and crane operation conditions such as extension, retraction and swinging.
- Inspect the sound, vibration, heat and odor of the Machine, and check for instrument errors, air leaks, oil leaks, fuel leaks, water leaks and other bad factors. Be extra careful with fuel leaks.
- Always repair broken part whenever an abnormality is found.  
Attempt to use without servicing may result in unexpected bodily accidents and/or Machine failures.

### CAUTIONS WHEN STARTING TO MOVE MACHINE

To prevent serious injuries and death accidents, always execute the followings before moving the Machine.

- Set the Machine to the traveling posture in the right diagram.  
Do not travel when the hook block is not contained.
- Make the boom fully lowered and retracted.
- Fix the hook block to the containment position.
- Make the outrigger contained.
- ★ See "Operation 2.5 Machine Travel Posture" for details.
- Make sure again that no one or object is in the vicinity before starting to move.
- Blow the horn for warning before starting to move.
- Always remain seated in the cab seat during traveling operation of the Machine.
- The Machine is prohibited to travel when a person or load is on the traveling dolly or the boom.
- When traveling, stow hook and outrigger, and make sure the surrounding safety.
- When stowing outriggers, insert each position pins completely to lock.

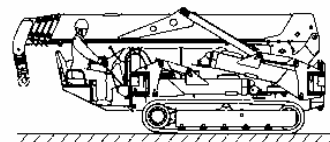

XAM22750

### CAUTIONS WHEN MOVING FORWARD/BACKWARD OR CHANGING DIRECTION

Always observe followings to prevent serious injuries and deaths when moving the Machine.

- Drop the speed early and wait until the Machine stops before changing from forward to backward, or backward to forward.
- Blow the horn and alert to the people nearby before changing between forward/backward movements or changing direction.
- Check that no one is around the Machine.  
The front of the Machine frame requires special attention because certain part of vision is blocked, so stop the Machine as necessary and make sure no one is at front or around.
- Place a guide if the location is hazardous or with bad view.
- Make sure to prevent people from crossing the moving direction or be at the direction to be changed.

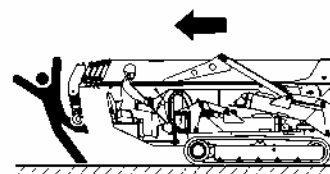

XAM22790

## CAUTIONS WHEN TRAVELING

Always observe followings to prevent serious injuries and death accidents when the Machine is traveling.

- Do not attempt looking sideways or other dangerous act when driving.
- Do not over speed, start moving sudden, stop sudden, swing sudden or meander since such acts are dangerous.
- ALWAYS remain seated in the cab seat when operating during drive.
- Whenever you find a machine abnormality (sound, vibration, odor, instrument error, fuel leak, water leak or oil leak), immediately park the Machine in a safe location and inspect the cause.
- Do not operate to suddenly change the direction. Such may cause the Machine to lose the balance or to damage the Machine or nearby object.
- When traveling over uneven terrain, travel as slow as possible to prevent tripping, and avoid acute operation when changing the direction.
- Avoid moving over obstacles as much as possible.  
Travel as slowly as possible when moving over an obstacle for unavoidable reason. Also, do not move diagonally over obstacles that cause the Machine to tilt excessively (10 degrees or more).
- When traveling, ensure extra clearance to prevent accident of contacting other machinery or object.
- When traveling in the water or crossing over shallow water, check the ground condition, depth and water velocity beforehand and make sure not to exceed the allowable water depth (no higher than center of idler (1)).
- ★ See "Operation 2.12 [2] Allowable Water Depth" for details.
- Check the withstand ability against the Machine mass before crossing over a bridge or construction that is a private property. In case of highway, ask the applicable road management administration and follow the given advice.
- Do Not travel with load hoisted.

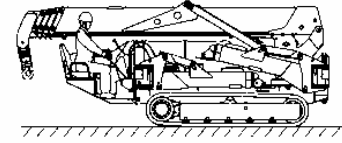

XAM22750

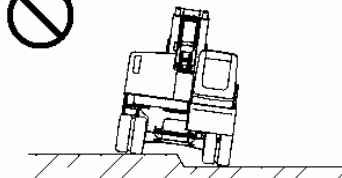

XAM05241

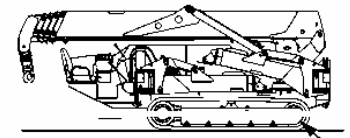

XAM22770

## BE CAREFUL WHEN TRAVELING OVER SLOPE

ALWAYS observe followings to prevent serious injuries and death accidents when traveling over a slope for unavoidable reason.

- Be careful of tripping and skids when traveling over slope.
- Do not change orientation on or horizontally when traveling over slope. Practice safe traveling by for instance lowering to the plain land and divert.
- ★ See "Operation 2.12 [3] Cautions on Upward/downward slope" for details.
- Skids happen more than you think on grasses, fallen leaves, and on wet steel plates.  
Avoid the Machine from being horizontal over the slope as much as possible, and decrease the speed sufficiently.
- Travel slowly by low speed when traveling downhill. In addition, brake (by setting the travel lever to neutral) as necessary.

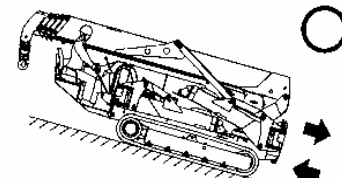

XAM22780

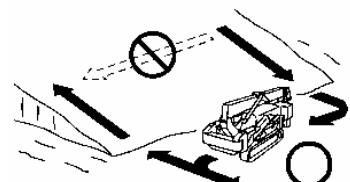

XAM05261



## BE CAREFUL OF TRIPPING ON UNSTABLE GROUND

Always observe followings to prevent serious injuries and death accidents when traveling over an unstable ground for unavoidable reason.

- Do not enter soft ground area. The Machine is difficult to evacuate from such area.
- The ground near cliff, roadside and deep gully is unstable, so avoid going near such ground as much as possible.
- The Machine may trip or fall when the ground loosens due to mass and/or vibration of the Machine. Be especially careful that the ground is likely loosen after rain, use of dynamite or earthquake.
- Avoid going near the earth fills or vicinity of dug gutter that are instable.

Crumbles caused by mass and/or vibration of the Machine may cause the Machine to tilt.

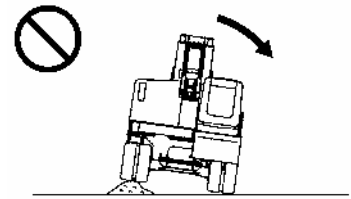

XAM08711

## CAUTIONS WHEN SNOW COVERED OR FROZEN

Always observe followings to prevent serious injuries and death accidents when traveling over a snow covered ground or frozen road for unavoidable reason.

- The snow covered grounds and frozen roads cause slips even when the inclination is small, so decrease the speed when traveling and avoid starting sudden, stopping sudden stop and swinging sudden. Uphill and downhill are especially likely to cause slips and thus dangerous.
- Ground of the frozen road becomes soft when the air temperature rises and causes the Machine travels and other operations to be unstable. Be very careful.
- Under cold weather, check that the load to be hoisted is not frozen stuck to the ground or other substance. Attempt to hoist without knowing the load is frozen stuck to the ground or other substance is dangerous.
- Do not directly contact metal surface with your body part such as a finger or hand under cold weather. Attempt to contact the metal surface of the Machine under harsh cold weather may cause the skin to stuck frozen to the metal surface.
- Remove snow and/or ice laid on the Machine that causes the safety nameplates to be hard to read. Be especially careful to securely remove those that are on the boom and thus may fall.

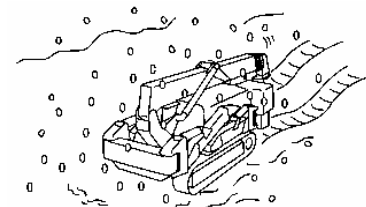

XAM05620

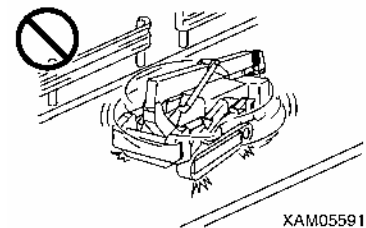

XAM05591

## CAUTIONS WHEN PARKING

- Park at a location where the ground is level, rock falls and landslides do not occur, is a lowland and flood does not occur.
- To park on a slope for unavoidable reason, use blocks as pawls to immobilize the Machine.
- When parking on the street, place the flags, protection barriers, lighting and similar objects, and caution notices without interfering the traffic, so that other traveling machines can notice clearly.
- Stop the engine before leaving the Machine. Always bring back the starter key with you and store in a fixed location.
- Stop the engine before leaving the Machine.
- When parking, the lock lever must be placed to "Lock".

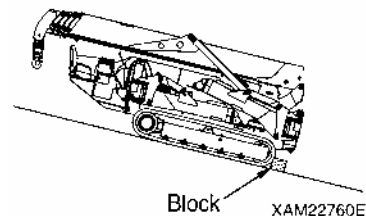

XAM22760E

## CAUTIONS UNDER COLD WEATHER

- Remove snow from and defreeze the swing gear, boom and winch related parts, and check the movements before work.
- Warm up enough.  
Attempt to operate the operation levers and switches without enough warm-up causes the Machine to react dull, and may result in unexpected accidents.
- Avoid acutely accelerating the engine during short time after starting the engine.
- Increase the oil temperature of the hydraulic circuit by relieving the oil pressure (let the pneumatic oil to escape to the hydraulic oil tank by raising to above the hydraulic circuit set pressure) by using operation lever. Doing so improves the Machine reactions and prevents improper operations.
- If the battery fluid is frozen, do not charge battery or start the engine using other power source.  
Such act may cause the battery to catch fire.  
Before charging or starting up using other power source, defreeze the battery fluid and check that failures such as battery fluid leak do not exist.
- After end of the work, wipe off and apply wraps if substances such as condensation, snow or mud are stuck to the wire harness, connector (1), switches, sensors or similar part.  
If the infiltrated condensation and/or similar substance freezes, the Machine may operate improperly upon the next use and cause unexpected accidents.

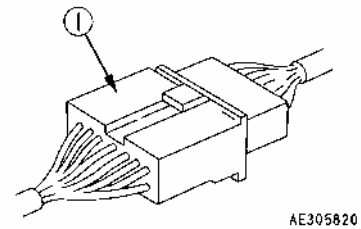

## 2.3 WORKING WITH CRANE

### INSPECTION BEFORE STARTING WORK

Check that the safety devices and crane operate properly.

- Operate each of the operation levers and switches under no load, and check that operations take place without abnormality.

Repair immediately if any abnormality exists.

- Check that the safety devices such as the moment limiter, outrigger safety device, and over hoist detector / automatic stop device activate properly.

### CAUTIONS WHEN HANDLING MOMENT LIMITER

- Use/store the moment limiter under the following ranges of ambient temperature.  
★ Temperature of use: 10 to 50 °C Storage temperature: -20 to 60 °C
- Avoid direct sunlight so that the temperature of the moment limiter body does not exceed the above range.
- Avoid locations with strong acid or alkaline atmosphere as much as possible. Otherwise, unexpected failures may occur.
- Do not apply impact to the moment limiter body for instance by colliding with an object. Such attempt may damage the case and may result in failures and improper operations.
- Do not push the panel sheet of the moment limiter body by a force more than necessary or push with sharp object such as a tip of a screwdriver. Such act may damage the panel sheet and may result in failures and improper operations.
- Do not remove the case cover or panel sheet from, or disassemble the moment limiter body. Such act may damage case and/or panel sheet and may result in failures and improper operations.

### CAUTIONS WHEN SETTING UP MOMENT LIMITER

- The moment limiter calculates the moments assuming the Machine is level.  
If you work with the crane when the Machine is not level, warnings and alarms are not issued even when the rated total load is near.  
Always set the outrigger horizontally to the ground while looking at the level gauge.
- Before using the crane, check that the boom angle display, boom length display and real load display of the moment limiter are displayed correctly following the crane movements. Attempt to use without correct display results in failure to obtain correct measurement result and may result in serious bodily accidents caused by reasons such as an improper operation and/or breakage of nearby equipment.
- Always make sure the wire strand setting of the moment limiter matches with the wire strand of the crane. If the wire strands do not match, always let the wire strands match by changing the wire strand setting of the moment limiter or by changing the wire strand of the crane. Attempt to use with unmatched wire strands results in failure to obtain correct measurement result and may result in serious bodily accidents caused by reasons such as an improper operation and/or breakage of nearby equipment.
- Do not carelessly change the setting when measuring with the moment limiter. Such attempt results in failure to obtain correct measurement result and may result in serious bodily accidents caused by reasons such as an improper operation and/or breakage of nearby equipment.

### PLACE CRANE ON LEVEL AND HARD SOIL

- Always place the outriggers on a level, stable and solid ground.  
Attempt to work with crane without outriggers firmly contacting the ground may cause the Machine to trip.
- Always place all outriggers before working with crane.
- Do not set any outrigger near the location that may collapse, for instance a soft ground, roadside or drilled hole.  
In case the outriggers need to be placed on a soft ground for unavoidable reason, always reinforce the ground by laying a sufficiently large and strong base plate below each of all outrigger supports.

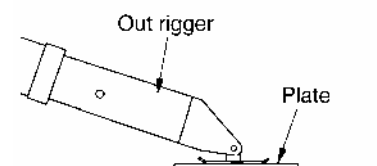

XAM05860E

## CHECK OUTRIGGER PLACEMENT CONDITION

Always observe followings to prevent serious injuries and death accidents when placing the outriggers.

- When placing the outriggers, always keep the Machine sternly level while looking at the level gauge. Occasionally view the level gauge and make sure to keep the Machine level during the crane works as well.
- Place the outriggers at a maximum extension condition as the basic rule.

In case of placing in a non-maximum extension condition for unavoidable reason, always find the values outrigger middle extension or outrigger minimum extension values in the rated total load chart before work.

- Place the outriggers in a style that the rubber tracks are approximately 50 mm above the ground.
- Make sure all of the outrigger position pins are securely fixed.

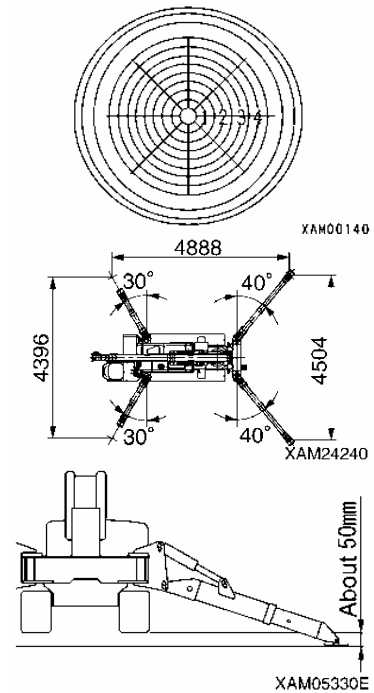

## CAUTIONS WHEN PLACING OUTRIGGER

- Do not let people approach nearby when placing the outriggers. Otherwise, serious accidents for instance the outrigger support catching a foot may occur.

- Always set the emergency stop cancel switch at side of the instrument panel to OFF (auto) position before outrigger operation. Do not attempt any outrigger operation with the emergency stop cancel switch at ON (cancel) position. Inspections and maintenance works are the only occasions where the emergency stop cancel switch is set to ON (cancel) position.

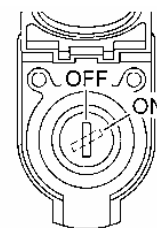

XAM19640A

## CAUTIONS HIGH TEMPERATURE OIL WHEN WORKING WITH CRANE

When hydraulic oil temperature exceeds 80 degrees, high pressure hoses and seals can be damaged by heat, and it may cause burn by spouted oil.

If temperature of hydraulic oil becomes over 80 degrees, stop operation and wait until the oil cools down.

Continuous hook raising / lowering operation at high working lifting height and a long time accelerated operation are easier to raise oil temperature. Especially be careful for these operations.

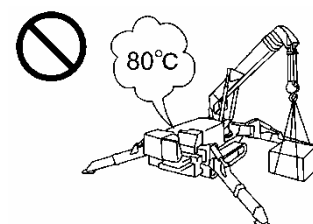

XAM35690

## BEWARE OF ELECTRICAL CABLE ABOVE

- Do not let the Machine contact with electrical cables above. High voltage cables may inflict electrical shock by mere approaching.
- Persons who sling are likely to suffer electrical shocks. Always observe followings to prevent accidents.
  - If the boom or the wire ropes may contact an electrical cable in the workplace, consult the electricity company and make sure that the measures (measures for instance placement of a guard personnel or application of wrap tubes and warning tags to the electrical cable) stipulated by the related regulations are taken before starting work.
  - Put on rubber soled shoes and rubber gloves, and be careful that the body parts unprotected by rubber or other insulation do not contact the wire rope or the Machine frame.
  - Place a guide and let him/her watch so that the boom, wire rope or Machine frame does not go near the electrical cable too much. Before doing so, decide the emergency signs and other necessities.
  - Ask the electricity company for the voltage in the electrical cables in the working site.
  - Ensure the offset distances (safe distance) shown in the following table between the boom/Machine frame and electrical cables.

|                                    | Voltage of Electrical Cable | Minimum Safe Distance |
|------------------------------------|-----------------------------|-----------------------|
| Low voltage<br>(Distribution line) | 100·200V                    | 2m                    |
|                                    | 6,600V                      | 2m                    |
| Special<br>(Transmission line)     | 22,000V                     | 3m                    |
|                                    | 66,000V                     | 4m                    |
|                                    | 154,000V                    | 5m                    |
|                                    | 187,000V                    | 6m                    |
|                                    | 275,000V                    | 7m                    |
|                                    | 500,000V                    | 11m                   |

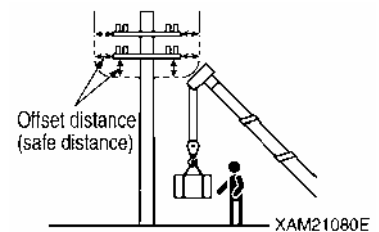
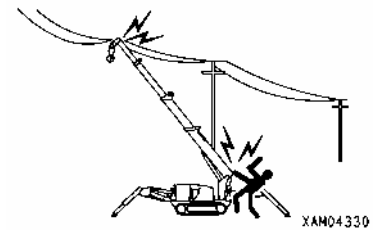

## **MEASURES WHEN CHARGE ACCIDENT OCCURS**

When an electrical charge accident occurred, do not panic but calm down, and apply solution by the following sequence.

### **1. Report**

Immediately report to the electricity company or related management company, and receive instructions for the power transmission stop, emergency procedures and related.

### **2. Evacuation of related personnel from vicinity of Machine**

Let the related personnel including the workers from vicinity of the Machine to prevent secondary disasters.

Personnel who suffered electrical shock by holding a sling rope, guide rope or other conductor when the Machine was charged should evacuate by his/her own effort.

Do not try to help such person. Otherwise, secondary electrical shock accident occurs.

### **3. Emergency procedure**

Take the solution by following sequence in case of urgency where personnel received electrical shock because the Machine was charged.

(1) If the Machine can be operated, immediately operate the Machine to move the Machine constructions away from the contact and out of the range of the cause of the charge. Be careful not to snip the distribution power cable.

(2) Evacuate the Machine completely away from the cause of the charge, make sure the Machine is not charged, rescue the electrically shocked personnel and immediately carry to the hospital.

### **4. Measure after accident**

After accident, do not reuse as is. Such attempt may cause unexpected accidents and enhances failures.

Ask us or our sales service agency for repair.

## **CAUTIONS WHEN WORKING WITH CRANE IN LOCATION WITH HIGH OUTPUT MICROWAVE EMISSION**

Working with crane near a high output microwave emission equipment such as a radar or TV/radio broadcast antenna causes the crane construction to be exposed to the microwave and generates induced current, therefore is very dangerous. In addition, the mechatronics may become haywire.

Establish grounding between the Machine frame and the ground when working in such location. In addition, slingers are requested to wear rubber boots and rubber gloves since risk of electrical shock by contacting parts such as the hook or wire exists.

## PAY ATTENTION TO WEATHER INFORMATION

- In case of thunderstorm, risk of lightning exists, so abort working with crane, immediately lower the load and contain the boom.
  - Exposing the hoisted load to wind causes the load to waggle and causes the Machine to be unstable, thus is dangerous. Immediately lower the load and contain the boom when the wind is causing the load to waggle.
  - If the maximum instantaneous wind speed is 10 m/s or greater, abort working with crane, immediately lower the load and contain the boom.
  - Even when the maximum instantaneous wind speed is below 10 m/s, bigger the hoisted load, higher the hoisted load position, and longer the boom, the wind effect increases accordingly. Be fully careful during work.
  - When a load such as a steel plate that has a large area exposed to wind is being hoisted, the wind arriving from front/rear/side of the boom may cause the Machine to trip or damage the boom. Be fully careful when working.
  - When an earthquake occurs, abort working and wait until the earthquake is over.
- ★The following table indicates approximate relation between the wind speed and wind effect. The wind speed mentioned in the weathercast is mean wind velocity (m/s) during 10 m at 10 m above the ground.

| Force | Wind Speed (m/s)  | Effect On Land   |
|-------|-------------------|--|
| 0     | Less than 0.3     | Smoke rises vertically.  |
| 1     | 0.3 - below 1.6   | Wind motion visible in smoke.  |
| 2     | 1.6 - below 3.4   | Wind felt on exposed skin.   |
| 3     | 3.4 - below 5.5   | Leaves and smaller twigs in constant motion.   |
| 4     | 5.5 - below 8.0   | Dust and loose paper raised. Small branches begin to move.                                   |
| 5     | 8.0 - below 10.8  | Smaller trees sway. Some foam and spray.   |
| 6     | 10.8 - below 13.9 | Large branches in motion. Whistling heard in overhead wires. Umbrella use becomes difficult. |
| 7     | 13.9 - below 17.2 | Whole trees in motion. Effort needed to walk against the wind.                               |
| 8     | 17.2 - below 20.8 | Twigs broken from trees. Progress impeded.   |
| 9     | 20.8 - below 24.5 | Light structure damage. Slates blown off.  |
| 10    | 24.5 - below 28.5 | Trees uprooted. Considerable structural damage.  |
| 11    | 28.5 - below 32.7 | Widespread structural damage.  |

## CAUTIONS WHEN SLINGING

- Check the following before hoisting a load.  
Attempt to hoist the load without checking may result in serious bodily accidents by a drop of the load or tripping.
- Observe the values in the rated total load chart.
- Hoist from the center of gravity of the load.
- Check that the wire ropes of the hook block are perpendicular to the ground.
- When the load leaves the ground, stop winding up the load once and check whether the load is stable.
- Before hoisting a slung load, always check whether the sling wire rope "retainer device" of the hook block is hung for sure. If the "retainer device" is not hung, the wire rope may leave the hook block and cause the load to fall and results in a serious accident.
- Larger wire rope angle when hoisting the load increases force that applies to the wire rope even when the load weight is unchanged, thus may cause the wire rope to snip. Pay enough consideration well when slinging to prevent excessive force from applying to the wire rope.
- Do not hoist more than loads at once.  
Such attempt may cause the hoist bracket to hit and damage the other hoisted load, the loads to move and lose balance and cause trip, or other cause of serious accidents.  
Do not hoist more than one load even if the total is within the rated total load.
- Hoisting of lengthy load causes the load to lose balance and is dangerous.  
In case such load, hoist vertically by using a clamp, or achieve balance of the hoisted load by applying a rope to both ends of the load.

## CAUTIONS WHEN HANDLING WIRE ROPE

- The wire rope fatigues as the time passes, so inspect every time before work, and replace immediately if at or beyond the replacement standard.  
At the same time, inspect the sheave at the tip of the boom and the sheave of the hook block. Damaged sheaves accelerate the damage of the wire ropes.
- Use the wire ropes specified by us.
- Always put on leather gloves when handling the wire rope.
- Handling worn and damaged wire may cause injury by wire splinter.
- Do not use any wire rope of which any of the followings apply.
  - 10% or more of the wires (except the filler wires) in one twist of the wire rope are snapped.
  - The wire rope diameter abrasion is beyond 7% of the nominal diameter.
  - Is kinked.
  - Is excessively deformed or corroded.
  - Affected by heat or sparks.

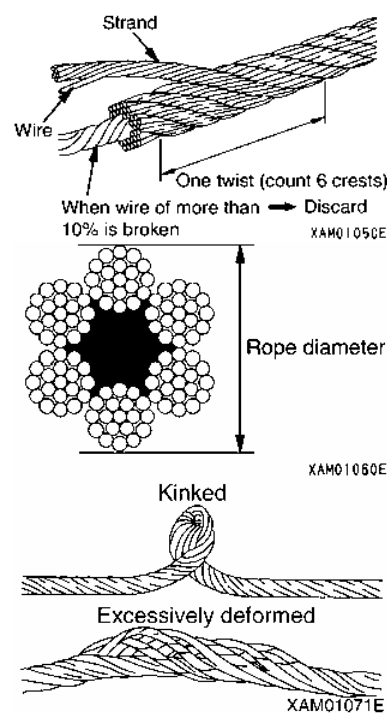



## CAUTIONS WHEN WORKING WITH CRANE

- Be sure to verify that the emergency stop cancel switch is at OFF (auto) position before operating the crane.  
Do not attempt the crane operation when the emergency stop cancel switch is at ON (cancel) position. The emergency stop cancel switch is permitted to be at ON (cancel) position only during the inspection or maintenance works.
- Crane works are not possible when the outriggers are placed in extension condition. Also, the crane work becomes halted when an outrigger support leaves the ground during the crane work. Securely place the crane in the extension condition, and avoid operations and works that may cause the machine to vibrate when working with the crane.
- Attempt to work beyond the capacity of the Machine may cause serious accidents and failures caused by for instance tripping or fluctuation. Observe the rated total load chart when working with the crane.
- Do not travel with a load being hoisted under any circumstance.  
Such attempt may cause the crane to trip and may result in serious bodily accidents.
- Be slow when operating the crane.  
Sudden lever or accelerator operations may cause risks such as wagging or fall of the load and collision with the surrounding. Be especially careful to be slow during the swing operations.
- Do not let people approach the work radius or below the load, since risks such as fall of the load and contact with the load exist. Such attempt may result in serious bodily accidents. Also, during the work, consider the fact that the working radius increases when the load is hoisted and the boom is deflected thus.
- Attempt to work with the crane even when the view is bad due to location or weather is dangerous.  
Ensure brightness by posting a work lamp or other illumination facility in dark places.  
When the view is bad because of bad weather (rain, fog, snow), abort working and wait until the weather recovers.
- Do not use for purpose, for instance raising a person using a crane, other than the true purpose.
- If the overwinding detector alarm buzzer is heard, immediately leave your hand from the winch lever. The hook block winding stops. Then, operate the winch lever to Down (push forward) to wind down the hook block. In addition, the hook block is wound up when the boom is extended, so be sure to ensure extra clearance between the boom and the hook block during work.
- When the boom extends, the hook block is wound up.  
Operate the winch lever to Down (push forward) to wind down the hook block while you extend the boom.
- Whenever an overload occurs during work, lower the load by winding down the winch by setting the winch lever to Down (push forward).  
Do not raise or lower the boom acutely. Such attempt may cause serious accidents by tripping.
- The volume of the hydraulic oil in each of the cylinders changes depending on the temperature.  
By leaving idle with a load being hoisted, as the time passes by the oil temperature drops and the hydraulic oil volume decreases, and changes such as the boom derrick angle decrease and boom length decrease may occur.  
In that case, execute boom derricking operations and boom extension operations appropriately to correct.
- Do not leave the driving operation position when a load is hoisted.  
Lower the load before leaving the Machine.
- Keep the hook block wound up when not in use.  
Otherwise, person near the load may collide the hook block without load.
- Operator must not leave operation seat during operation.

## CAUTIONS WHEN OPERATING WINCH

- Do not let persons enter below the hoisted load.
  - When hoisting a load, always stop once at the "takeoff" position where the hoisted load leaves the ground. Check subjects such as load stability and load force, then hoist up the load.
  - Do not pull laterally, pull toward you or hoist diagonally. Such attempt may cause the crane to trip or suffer damage.
  - Overwinding of the hook block may result in collision with the boom, snipping the wire ropes and causes the hook block and load to fall and cause serious accidents. Be fully careful to prevent overwinding the hook block.
  - Be careful to prevent the wire rope and/or hoisted load from contacting an obstacle such as a tree or steel when hoisting a load. If caught by an obstacle, do not forcibly wind up the hoist load, but untangle the caught part before winding up.
  - Do not use the winch drum wire rope in random condition. If random, not only the wire rope suffers damage and shortens the lifetime, but the wire rope may snip and causes serious accidents. Observe following precautions to avoid wire rope from becoming random.
    - Do not let the hook block hit the ground.
    - Before leaving the hook block lowered for a long time for instance when working with underground, leave at least three loops of wire rope in the winch drum.
    - If the wire rope is twisted and causes the hook block to turn, fully eliminate the twist before work.
- ★ See " Operation 4.2 What to do with Twisted Winch Wire Rope" for details.

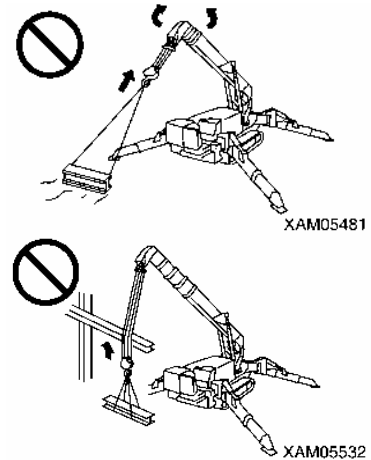

## CAUTIONS WHEN OPERATING BOOM

- Be slow as much as possible when operating the boom operation lever. Especially avoid sudden lever operations when the load is hoisted, which may cause the load to wobble and give large impact to the Machine, and thus may damage the crane or trip the Machine.
- When the boom is lowered, the working radius increases, and the rated total load that can be hoisted decreases. When working while raising/lowering the boom, pay extra attention so that the mass (weight) of the load at the time the boom is most lowered does not cause overloading.
- Attempts to pull the load laterally or pull to bring forth the load by raising/lowering and/or extracting/retracting operation of the boom are prohibited. Do not attempt under any circumstance.
- Be aware of the hook block windup condition and exercise caution when extending or retracting the boom.
- When the boom is extended, the working radius increases, and the rated total load that can be hoisted decreases. When working with extending/retracting the boom, pay extra attention so that the mass (weight) of the load at the time the boom is most lowered does not cause overloading.

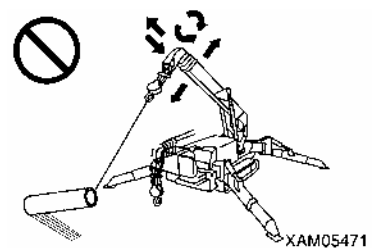

## CAUTIONS DURING SWING OPERATION

- Check the safety in the vicinity and blow the horn before swinging.
- If the boom derrick angle is small, be careful to prevent the boom from hitting the driver or the Machine.
- Be slow as much as possible when operating the swing lever. Make sure to start smoothly, swing slow, and stop quietly. Especially avoid sudden lever operations when the load is hoisted, which may cause the load to waggle and cause the Machine to lose balance, and thus may damage the crane or trip the Machine.
- Attempts to pull to bring forth the load or let the load stand up by swinging operation are prohibited. Do not attempt under any circumstance.
- Be careful to prevent the wire rope and/or hoisted load from contacting an obstacle such as a tree or steel when hoisting a load or when swinging. If caught by an obstacle, do not forcibly wind up the hoist load, but untangle the caught part before winding up.
- Certain outrigger extension condition may cause the boom to hit an outrigger and cause the crane to be damaged or the Machine to trip. Be careful to prevent the boom from hitting outriggers during swing operation.

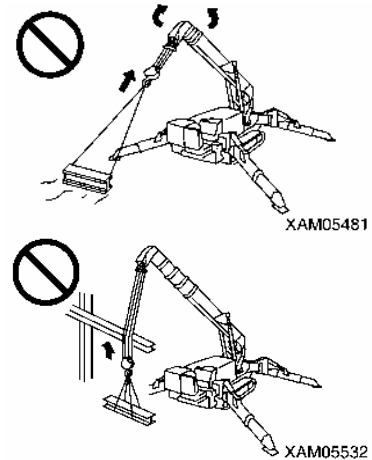

## COOPERATION HOISTING IS PROHIBITED AS THE RULE

Cooperation hoisting, that is to use more than one crane to hoist a load, is prohibited.

The cooperation hoisting work is a highly hazardous work that may cause for instance a trip of the Machine due to uneven center of gravity, fall of the hoisted load or boom damage.

If the need to work so exists for unavoidable reason, establish a work scheme by responsibility of the user, discuss fully, let the worker fully acknowledge the work method and procedures, then work carefully under the direct leadership of the work supervisor.

And, observe the following cautions as well.

- Use the cranes of same model.
- Choose the Machine model that can handle sufficiently larger load than the load to be hoisted.
- Make sure only one person gives signs.
- Limit the crane operations to single operations as the rule, and do not attempt any swing operation.
- Appoint one responsible slinger who is most experienced.

## WORKING AT THE SITE WITH UNDERGROUND LIFTING

- Leave at least three loops of wire rope in the winch drum when winding down the wire rope in case of underground work or similar occasion. This Machine is equipped with three-winding stop alarm / automatic stop device as the safety device, but even then be fully careful to prevent this safety device from activating.
- Make sure signs are communicated fully.
- Be especially careful with the crane operations.

### 3. TRANSPORT PRECAUTIONS

#### CAUTIONS WHEN LOADING OR UNLOADING

- Be especially careful when loading or unloading the Machine because the risks intervene.
- Select a location that is level and has firm road surface when loading or unloading the Machine. In addition, keep enough distance from the roadside.
- Use the ramps under 15 degrees or smaller angle. In addition, decide the clearance between ramps to meet the center of the rubber tracks.
- Always set the Machine in the "traveling posture" and securely insert the position pins (4 pieces) to the outrigger rotary parts before loading or unloading the Machine.
- ★ See "Operation 2.5 Machine Travel Posture" for details.
- Always move backward when loading the Machine. Moving forward may cause a trip.
- When loading or unloading, set the engine rotation to low idling (low speed rotation) and operate slowly by low speed travels.
- Use the ramps that have fully strong width, length and thickness, and that enable safe loading/unloading. Reinforce with blocks or other substances if the ramps deflect much.
- Remove the mud and other substances from the footing to prevent the Machine from skidding over the ramps. Remove the substances stuck the ramps such as grease, oil or ice, and keep clean. Be especially careful in the rainy days where slips easily occur.
- Do not change direction over a ramp. Temporarily leave the ramp before correcting the direction.
- Be slow when operating to change the direction on the truck platform where the footing is unstable.
- After loading the Machine, apply the wood blocks so that the Machine does not move, and securely fix with wire ropes or other means.
- ★ See "Operation 5.1 Loading/unloading" for details.
- ★ See "Operation 5.3 Cautions in Loading Machine" for details.

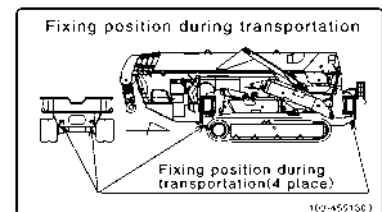
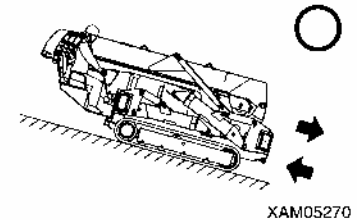
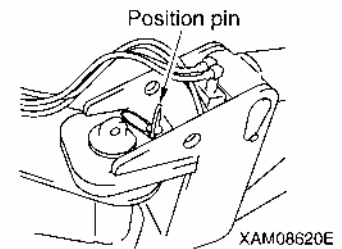
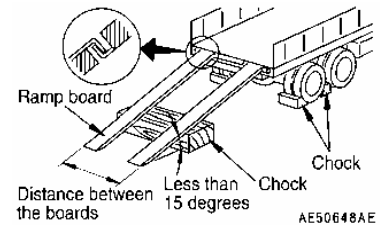

#### CAUTIONS DURING TRANSPORT

Observe the related regulations and exercise safety during transport.

## CAUTIONS WHEN LOADING/UNLOADING WITH CRANE

Be careful of the followings when loading or unloading the Machine by hoisting with a crane.

- Do Not use those brackets on the boom to hang the whole unit.
- Before hoisting the Machine, attach the hoisting brackets (1) (for instance shackles) to the outrigger rotary holes (four), and hang the wire ropes (2) (four) on the hook (3).

- To hoist, use the crane, wire ropes (2) and hoisting bracket (1) (for instance shackles) having enough strength against the Machine mass (weight).

Following is the load force that applies to each of the wire ropes when the Machine main body is hoisted by four wire ropes.

★ Standard specification: 975 kg

- ALWAYS set the Machine in the "traveling posture" and securely insert the position pins (4 pieces) to the outrigger rotary parts before hoisting the Machine.

The center of gravity position of the Machine has been decided under the condition where the Machine posture was "traveling posture".

★ See "Operation 2.5 Machine Travel Posture" for details.

- Use the carrying instruments shown the right figure and work safely when carrying the Machine using a crane.

★ Recommended hoisting equipment

- Wire ropes (two in front): 12.5 diameter x length of 2150 mm (breaking force of 7.5 t or more), with eye lock and nominal 12A thimble at one end
- Wire ropes (two in back): 12.5 diameter x length of 1650 mm (breaking force of 7.5 t or more), with eye lock and nominal 12A thimble at one end
- Shackle: BC or SC, nominal 14

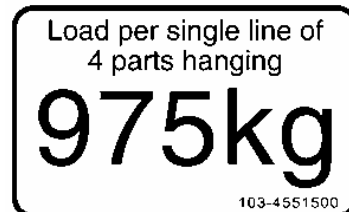
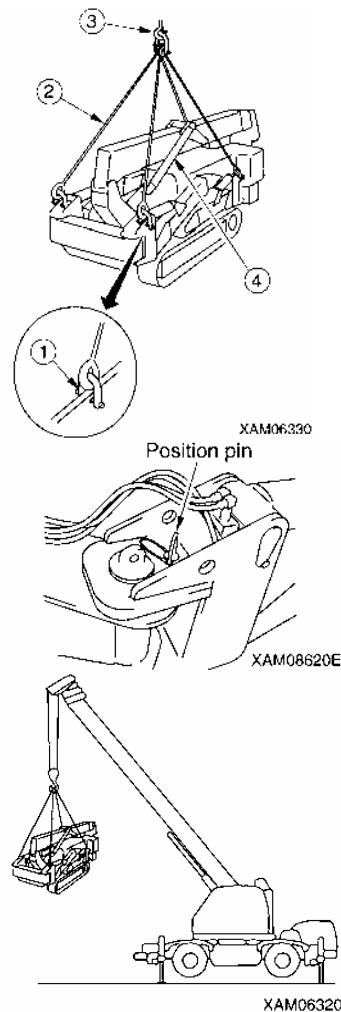

## 4. BATTERY HANDLING PRECAUTIONS

### BATTERY HANDLING CAUTIONS

The battery fluid includes diluted sulfuric acid, and generates hydrogen gas, and causes bodily accidents and fires if handle improperly, so always observe the followings.

- Do not let a cigarette or any fire source approach the battery.
- Always put on protective glasses and rubber gloves before handling the battery.
- If the battery fluid contacted clothing or skin, immediately wash away by huge quantity of water.
- If the battery fluid entered an eye, wash immediately with water and see the doctor as soon as possible.
- If you have swallowed the battery fluid by mishap, immediately drink huge quantity of water, milk, raw egg or vegetable oil, and see the doctor as soon as possible.
- Wipe with a wet clean cloth when cleaning the battery upper surface or related part. Do not use organic solvent or detergent for instance gasoline or paint thinner.
- Tighten the battery cap fully.
- If the battery fluid is frozen, do not charge battery or start the engine using other power source. Such act may cause the battery to catch fire.
- Before charging or starting up using other power source, defreeze the battery fluid and check that failures such as battery fluid leak do not exist.
- Always detach the battery from the Machine frame before charging the battery.

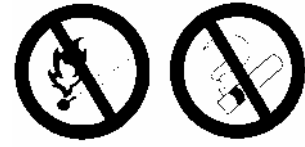

A0055040



A0055090



A0055170

### CAUTIONS WHEN STARTING UP USING BOOSTER CABLE

Wrong booster cable connection method may result in fire, so always observe the followings.

- Start the engine by two persons, with one standing on the driving operation position in the travel operation panel side.
- When starting using other Machine, be careful to prevent contact between the normal Machine and broken Machine.
- Keep the starter switch key of both the normal Machine and the broken Machine in OFF position when the booster cable is connected.
- Do not connect to wrong side [connecting (+) to (-), (-) to (+)] when connecting the booster cable.
- Start connecting from (+) terminal first, but start disconnecting from (-) terminal (ground) first.
- Connect the ground to the (-) terminal of the battery of the broken Machine when connecting the ground as the last procedure.
- ★ See "Operation 8.4 Starting Engine with Booster Cable" for details.
- Avoid the contact between clips of the booster cable, and contact between a clip and the Machine when disconnecting the booster cable.

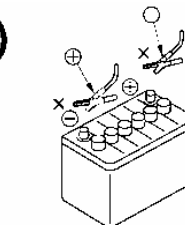

XAM22720

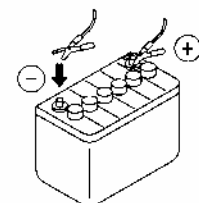
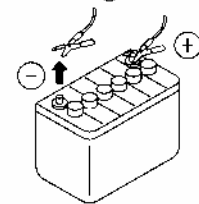

XAM04590

## CAUTIONS WHEN CHARGING BATTERY

Improper handling when charging the battery may cause the battery to explode. Follow the manuals attached to the Machine and the charger, and always observe the followings.

- ★ See "Operation 8.3 Cautions in Charging Battery" for details.
- Carry the charger to a location with good ventilation, then remove the battery cap. Doing so causes the hydrogen gas to disperse and prevents explosion.
- Adjust the charger voltage to suit the voltage of the battery to charge. Mistake in adjusting the voltage may cause explosions due to overheat and ignition of the charger.
- Securely fix the (+) charge clip of the charger to the (+) terminal of the battery, then securely fix the (-) charge clip to (-) terminal of the battery.
- Set the charge current to no more than 1/10 of the rated capacity of the battery, or, in case of quick charge, set to the rated capacity of the battery or smaller.
- Excessive charge current may cause leap fire and explosion caused by fluid leak or fluid deficiency.



A0055170

## 5. MAINTENANCE PRECAUTIONS

### 5.1 PRECAUTIONS BEFORE MAINTENANCE

#### FAILURE REPORT

Execution of a maintenance not described in our manual may cause unexpected failures. Ask us or our sales service agency for repair.

#### CLEAN BEFORE INSPECTION OR MAINTAIN

- Before starting an inspection or maintenance, clean the Machine and prevent rubbish from entering the Machine and make sure the safety will be ensured during maintenance.
- Attempt to inspect or maintain with the maintenance Machine still dirty not only lessens chance of locating faulty part, but may cause rubbish or mud entering your eye, or slipping and tripping that results in injury.
- Always observe followings when washing the vehicle.
  - Use antislip shoes to prevent slips and trips caused by wet foothold.
  - Put on protective equipment when using a high pressure steam car wash. Avoid the accidents that the contact with high pressure water causes the skin laceration or mud or other substance flying into eye.
  - Do not directly spray water onto electrical system (sensors, connector (1), receiving box and related). Entrance of water into the electrical system causes faulty operations and may trigger improper operations, thus is dangerous.

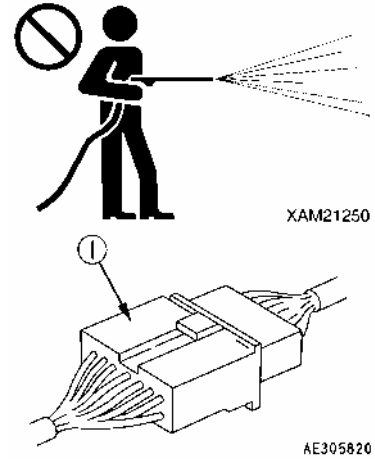

#### TIDY UP WORKPLACE

In the workplace, put away the tools, hammers and other things that obstruct the works, wipe of slippery items such as greases and oils, and exercise tidy up and cleaning for safe work. Untidy workplace may cause stumbles and slips that result in injury caused by tipping.

#### FOLLOW SUPERVISOR INSTRUCTION DURING TEAMWORK

Appoint a person who supervises the work and follow his/her instructions in case of Machine repair or installing/uninstalling a work device. Unexpected accidents due to misunderstood communication between workers may occur during teamwork.

#### USE APPROPRIATE TOOLS

Do not use damaged or deteriorated tool, or use a tool for a purpose that is not a proper purpose of use. Use tools suitable for the maintenance work. Entrance of a broken piece of a tool such as a boss with crashed head or a hammer may destroy eyesight.





## HANDLING ILLUMINATION DEVICES

- Use explosion proof illumination device when inspecting with fuel, oil, battery fluid or similar substance. Failure to use explosion proof illumination device may cause leap fire and explosion.
- Attempt to work without using illumination device in a dark place may cause injury or other issue. Always use illumination device. Do not use a lighter or other burning object even if dark. Such use may cause fire, and furthermore the battery gas may catch fire and explode.



A0055160

## STOP ENGINE BEFORE INSPECTION OR MAINTENANCE

- Before inspection or maintenance, always park the Machine at a location where the ground is level, rock-falls and landslides do not occur, is a lowland and flood does not occur, and fully retract and lower the boom, and stop the engine.
- Operate each of the crane operation levers forward backward several times to relief the pressure remaining in the hydraulic circuits.
- Apply pawls to so that the prevent rubber tracks do not move.
- Persons in charge of the maintenance should pay attention to prevent physical body and clothes from contacting the moving parts.

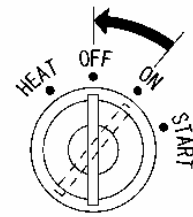

XAM21280

## FIRE RISK PREVENTION

- Always observe the followings during maintenance where the fuel, oil, battery or other substance that may catch fire is handled.
- Keep the fuel, oil and any other easily combustible oil and fats away from fire during storage.
  - Do not leave the site when replenishing the fuel or oil.
  - Use incombustible cleaning oil for the objects such as the components, and do not use light petroleum, gasoline or anything else that may catch fire.
  - Do not smoke when inspecting or maintaining. Smoke at a location designated to do so.
  - When inspecting fuel, oil, battery fluid or similar, use explosion proof illumination devices but do not use fires such as a lighter or a match for illumination.
  - Loosened and damaged electrical connections may cause short circuit that may result in a fire. Inspect accordingly during the inspections before starting work.
  - Make sure a fire extinguisher is place near the inspection / maintenance site.



A0055020



A0055040

## 5.2 PRECAUTIONS DURING MAINTENANCE

### NO UNAUTHORIZED PEOPLE

Do not admit anyone other than necessary workers during maintenance. And post a guard as necessary.  
Be especially careful in case of a polishing, welding work, or digging work.

### MEASURES UPON FINDING ABNORMALITY DURING INSPECTION

- Always repair whenever an abnormality is found during inspection. Attempt to use without repairing the defect may cause bodily accidents.
- Ask us or our sales service agency for repair depending on the failure type.

### DO NOT DROP TOOL OR PART INSIDE MACHINE

- Do not drop any bolt, nut or tool inside the Machine when inspecting while opening the inspection port or tank replenishment port. Dropped object may damage the Machine or cause the Machine to operate improperly and thus may cause accidents. If dropped, always retrieve.
- Do not keep anything unnecessary for the inspection in your pocket.

### NOISE CAUTION

Large noise in the surroundings may cause hearing difficulty or deafness.  
Put on ear covers or earplugs before long time noise exposure for instance an engine maintenance.

### WORK BY AT LEAST TWO PERSONS DURING MAINTENANCE WITH ENGINE RUNNING

To prevent accidents, do not attempt maintenance when the engine is running.

Always observe the followings in case of maintaining with the engine running for unavoidable reason.

- One should seat in the driving seat, and keep checking each other while ensuring that the engine can be stopped any time.
- Be especially careful when working near a rotating part which may entangle.
- Do not touch operation levers. Before handling an operation lever for unavoidable need, always give a sign to other person and let him/her evacuate to a safe place.
- Do not contact with the alternator drive belt or other part that severs upon contact with human body or tool.

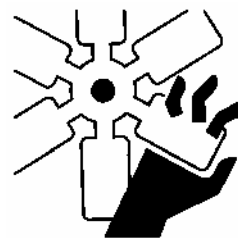

A0055210

### CAUTIONS WHEN WORKING BELOW MACHINE

- Park the car over a level and firm location, and fully retract and lower the boom.
- Before the maintenance below the Machine, extend the outriggers maximum so the Machine lifts. When doing so, insert support platforms (height increasers) below front and rear of the Machine to stabilize the Machine.



A0055140

### CAUTIONS WHEN WORKING ABOVE MACHINE

- Tidy the footing to avoid falling and always observe following precautions during maintenance above the Machine.
- Do not spill oil or grease.
- Do not sprawl the tools.
- Beware of the footing when walking.
- Do not jump from the Machine under any circumstance. Use a platform, and secure your body with three locations of the limbs (both feet and one hand, or both hands and one foot) when climbing up or down the Machine.
- Use protective equipment that suit the work.
- Do not step on the boom, outrigger or machinery cover to prevent bodily accidents such as falling or tripping due to slippage.



A0305870

### CAUTIONS WHEN REPLENISHING FUEL OR OIL

The fuel, oils and similar substance may catch fire if a fire comes near.

Light petroleum is used as the fuel and thus requires extra effort to observe the followings.

- Keep the engine stopped when supplying.
- Do not smoke when supplying.
- Immediately wipe away dripped fuel or oil.
- Securely tighten the fuel and oil caps.
- Supply fuel/oil at a location with good ventilation.
- Do not leave the site when replenishing the fuel or oil.



A0055020



A0055040

### BEWARE OF CHIPS WHEN WORKING WITH HAMMER

During the hammering works, keep protective equipment such as protective glasses and a helmet on, and insert a copper bar or similar object between the hammer and the target when hitting. Giving impact to a hard metal part such as a pin or a bearing may cause the broken chip to enter eye and inflict injury.

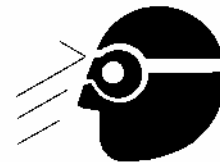

AE305880

## CAUTIONS DURING WELDING REPAIR

Weld in a location with good facility, and, only authorized personnel are permitted to weld. Unauthorized personnel are strictly prohibited since risks such as gas generation, fire and electrical shock are present when welding.

The personnel authorized to weld are requested to always observe the followings.

- Disconnect the battery terminals to prevent battery explosions.
- Peel off the paint from the welding section to prevent gas generation.
- Attempt to heat up a hydraulic machinery, piping or a section near such part may cause combustible vapor or mist to be generated and catch fire. Avoid heating such section.
- Directly heating a pressurized piping or rubber hose may cause a sudden snip. Apply a fire protection cover.
- Disconnect the wiring connectors of the radio control and remote control devices, moment limiter display and converter.
- Put on protective equipment.
- Keep the ventilation well.
- Put away the combustibles and prepare a fire extinguisher.
- Do not ground to a location near electrical part. Such may cause the electrical part to malfunction.

## DISCONNECT BATTERY TERMINAL

Disconnect (-) terminal of the battery and stop the electrical flow before repairing the electrical system or starting an electrical weld.

★ See "Operation 8. Battery Handling" for details.

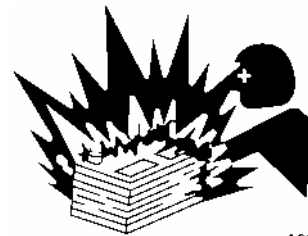

A0055170

## CAUTIONS WHEN ADJUSTING RUBBER TRACK TENSION

• Grease is sealed inside the rubber track tension adjuster. The grease is at a high pressure because of the tension of the rubber track. Attempt to release the grease without observing the following precautions may cause the grease valve to pop out and result in serious accident.

- Do not loosen the tension adjustment grease valve one full turn or above. Doing so may cause the grease valve may pop out.
- To avoid the risk during tension adjustment, do not place your body in right front of the grease valve.

★ See "Operation 2.1.3 [1] Checking/adjusting Rubber Track Tension" for details.



A0055200

## HIGH PRESSURE HOSE HANDLING CAUTIONS

Oil leaking from high pressure hose may cause fire or bodily accident due to faulty operation. Whenever a damaged hose or loosened bolt is found, abort working and ask us or our sales service agency for a repair.

- Replacement of high pressure hose requires experienced skill. In addition, the tightening torques are decided by the hose types and size.

Customers are prohibited to repair.

- Replace the applicable part if any of the following conditions is found.
  - Hose sleeve damage or leak.
  - Scratch or truncation of the coat, or exposure of reinforcing layer of a wire
  - Coat is partially swollen.
  - Indication of twist or collapse is at a movable part of hose.
  - Alien object buried in coating.
  - Hose sleeve deformation.

## HIGH PRESSURE OIL CAUTIONS

Failure to make sure the pneumatic circuit pressure is relieved before inspection or replacement of a high pressure piping or hose may result in bodily accidents.

Always observe the followings.

- Do not start any inspection or replacement before the pressure dissipates.
- Put on protective glasses and leather gloves.
- When a piping or hose leak exists, the piping/hose itself or vicinity or the ground is wet. If such is seen, a piping crack, hose crack or inflation is considerable, so always ask us or our sales service agency for a repair.
- High pressure oil leaking through a small hole may puncture the skin or destroy eyesight upon contacting with skin or eye. If the high pressure oil gave serious injury to skin or eye, wash away with flowing water and see the doctor as soon as possible.

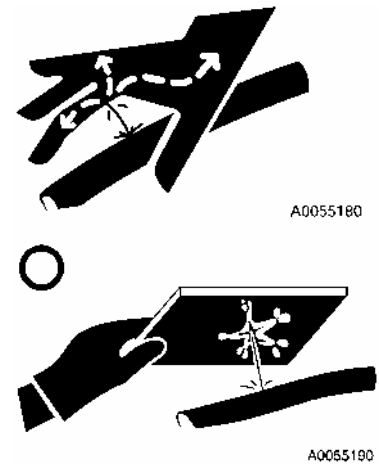

## CAUTIONS WHEN TEMPERATURE IS HIGH

Parts such as the engine, all oils, exhaust system manifold and muffler are at high temperature during short time after stopping the engine.

Attempt to remove the cap or execute a maintenance such as oil draining, water draining or filter replacement may result in suffering burns.

Wait until the temperature lowers, then execute the inspection/maintenance following the procedure written in this manual.

- ★Operation 2.1.2 Checking Before engine starting: checking cooling water level, checking oil level in engine oil pan, checking oil level in hydraulic oil tank.
- ★Maintenance 8.8 250 hours maintenance: Replacement engine lubrication oil and filter cartridge,
- ★Maintenance 8.9 500 hours maintenance: Replacement engine lubrication oil and filter cartridge, replacement hydraulic oil return filter
- ★Maintenance 8.10 1000 hours maintenance: Cleaning inside cooling system, replacement oil inside hydraulic oil tank

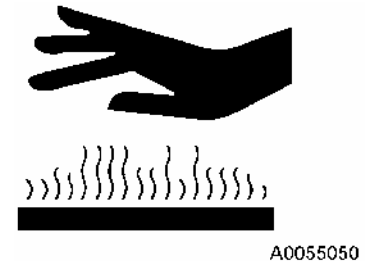

## CHECKS AFTER INSPECTION/MAINTENANCE

Failure to execute an inspection/maintenance item or failure to check the function and operation of the maintained part may cause an unexpected fault which may result in bodily accidents.

Always observe the followings.

- Checks with engine stopped
  - Check for unexecuted inspection/maintenance.
  - Check that inspection/maintenance was done without errors.
  - Check for any dropped tool or part. Ones caught by the interior or lever related link mechanism poses extra danger.
  - Check for any fuel leak, water leak, oil leak, bolt loose and similar issues.
- Check with engine running

Be fully careful with safety when checking with the engine running while referring to "Work by at least two persons during maintenance with engine running" section.

  - Check that the inspected/maintained part operates normally.
  - Check that issues such as an oil leak do not occur when load is applied to the oil pressure by increasing the engine rotation.

## CAUTIONS WHEN TREATING WASTE

Always observe the following to prevent pollution environment of the district inhabited with human or animal.

- Do not dispose the waste oil down a water system such as sewage or river.
- Always drain into a container when draining the oil from the Machine.

Do not directly drain to the ground.

- Observe the applicable legal regulations and rules when disposing harmful substance such as the oil, fuel, solvent, filter or battery.

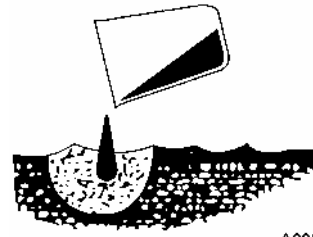

A0055220

# 6. SAFETY LABEL LOCATIONS

Keep these labels clean all the time.

If lost, apply again or replace with new one.

Labels other than the following safety labels exist, treat same.

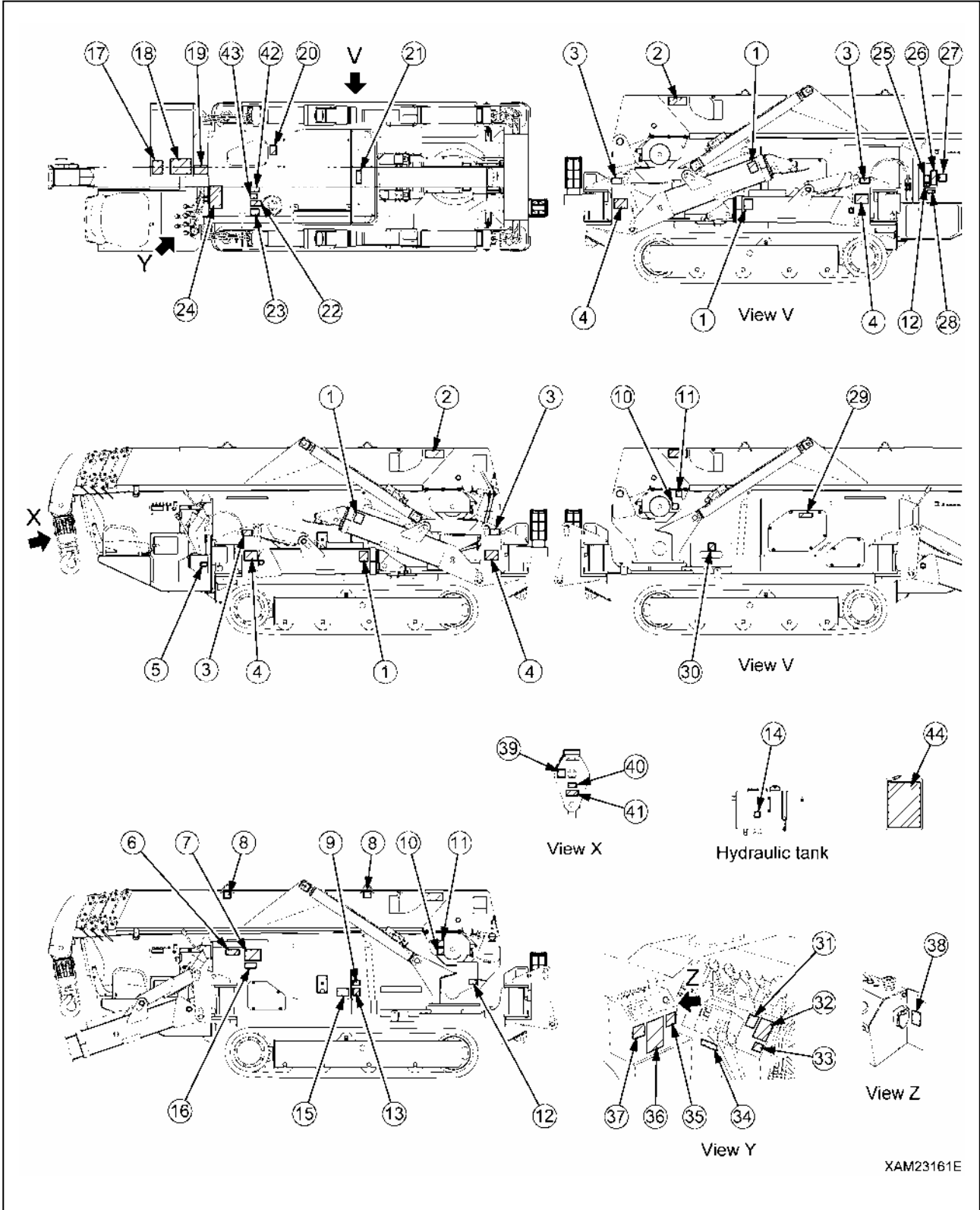

(1) Footing check (349-4427000) (4 places)



(2) Minimum hoist load (103-4551100) (2 places)

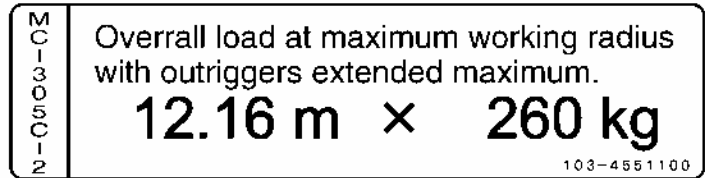

(3) Loads on 4-rope machine hoisting (103-4551500) (4 places)

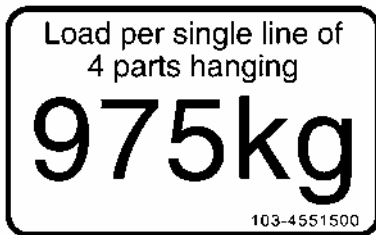

(4) Outrigger pin hole caution (349-4426900)

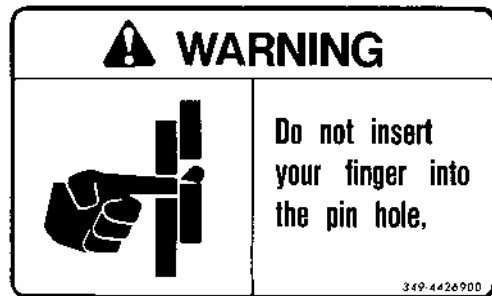

(5) Fixing bracket position during transportation (103-4551300)

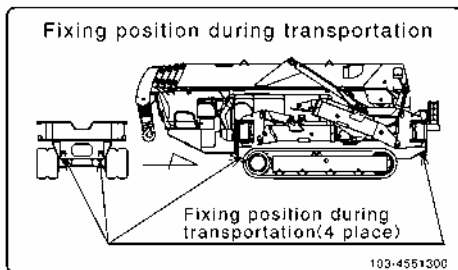

(6) Machine total weight (103-4551000)

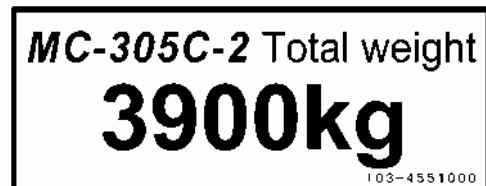

(7) 4-rope machine hoisting position (103-4551700)

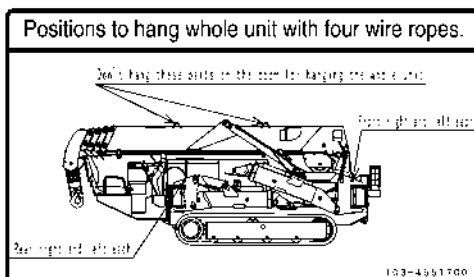

(8) Boom hoisting bracket caution (103-4553700) (2 places)





(9) Pinch caution (553-4267600)



553-4267600

(11) Warning (553-4268000) (2 places)



553-4268000

(13) Rotating fan caution (349-4526900)

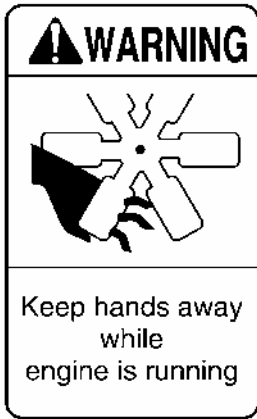

349-4526900

(15) Engine cover caution (349-4427900)

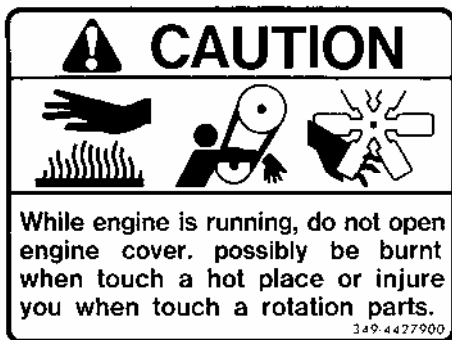

349-4427900

(10) Winch caution (For winch) (553-4267500) (2 places)



553-4267500

(12) Washing caution (350-4539700)

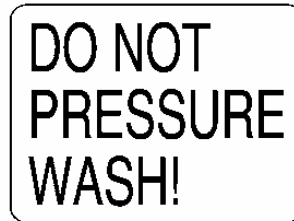

(14) High temperature caution (553-4267700)





553-4267700

(16) High pressure oil caution (349-4427200)

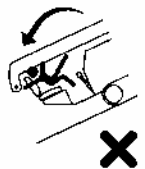

349-4427200

(17) Caution when traveling on slope (349-4421100)

| <b>⚠ WARNING</b>   |  |
|--|--|
|   | <p>For traveling on slope or ramp boards, be sure to position your carrier so that its operator seat comes to higher end. Otherwise, should the carrier slips down, injury to the operator may result.</p> |
| <p><b>Caution for traveling:</b></p> <ol style="list-style-type: none"> <li>1. When traveling, be sure to stow away outriggers as well as hook.</li> <li>2. Be sure to slow down for making turn or traveling over bad road.</li> <li>3. For standing or parking your carrier on slope, be sure to engage chocks.</li> </ol> |  |
| <b>⚠ CAUTION</b>   |  |
|   | <p>Do not traverse or make turn on slope as it can result in tipping over, Make a detour to go around the slope for safety.</p>  |

349-4421100

(18) Operating caution (349-3195100)

| <b>CHARACTERISTICS OF PERFORMANCE</b>  |   |
|--|---|
| <p>(1) Even with same working radius, lifting capability varies depending on the stage of boom in use. Further, slight change in working radius causes great change in the load that can be lifted.</p> <p>(2) Lifting capacity of crane reduces as its working radius increases.</p> <p>(3) Lifting capability varies according to the extension of outrigger (maximum, medium or minimum).</p> <p>(4) Stability changes depending on the direction of boom (forward, lateral or backward).</p> |   |
| <b>GENERAL RULES FOR USING CRANE</b>   |   |
| (1) Before work  | <ol style="list-style-type: none"> <li>1. Read the instruction manual carefully before starting to use your crane.</li> <li>2. Always perform the prior-to-work inspection.</li> <li>3. For crane work, be sure to ground the outriggers so that the machine is in level. Make sure all the four outriggers are grounded.</li> <li>4. Outriggers should be set up to maximum extension in principle.</li> <li>5. With the outriggers grounded properly, rubber tracks should be lifted off the ground by 50mm.</li> <li>6. For setting up the outriggers, insert the rotary position pins securely. Use care not to catch your finger in the hole.</li> <li>7. Check to see the over-hoist alarm system works properly (that buzzer sounds and hoist motion stops).</li> </ol>  |
| (2) During work  | <ol style="list-style-type: none"> <li>1. Stable lifting load varies according to outrigger setting and ground condition. Crane work with the outrigger footings lifted off the ground is dangerous and should not to be performed. Be sure to observe the Rated Total Load Chart.</li> <li>2. Do not perform overloaded operation which may invite tipping over or other damage to the crane.</li> <li>3. Crane work with engine running at high speed is dangerous.</li> <li>4. Use care not to allow the load to sway during crane work.</li> <li>5. Dragging load laterally, longitudinally or lifting it at angle may damage the crane and should be avoided.</li> <li>6. Do not leave your crane with load lifted.</li> <li>7. Do not allow anyone to enter under the boom during crane operation.</li> <li>8. While crane acceleration button is depressed, crane motion will be faster than normal and particular care should be used.</li> </ol> |
| (3) During travel  | <ol style="list-style-type: none"> <li>1. During travel, boom and hook should be stowed away respectively.</li> <li>2. Be sure to slow down for making turn or traveling over bad road.</li> <li>3. For parking on slope, be sure to apply chocks.</li> <li>4. For traveling on slope or ramp boards, be sure to position your carrier so that its operator seat comes to higher end.</li> </ol>  |
| (4) After work   | <p>Upon completion of work, be sure to turn OFF the main switch (key switch).</p>   |
| (5) Inspection and service   | <ol style="list-style-type: none"> <li>1. Prior-to-work inspection and monthly as well as annual periodical inspection should be carried out voluntarily.</li> <li>2. Any defect should be corrected whenever it is found through inspection.</li> <li>3. Replacement of consumables and lubrication, its replenishment or replacement should be carried out in accordance with the standards as provided in instruction manual or the like.</li> </ol>   |

349-3195100

(19) Diagram of working radius and lifting height (103-4550500) (20) Hydraulic oil caution (104-4550800)

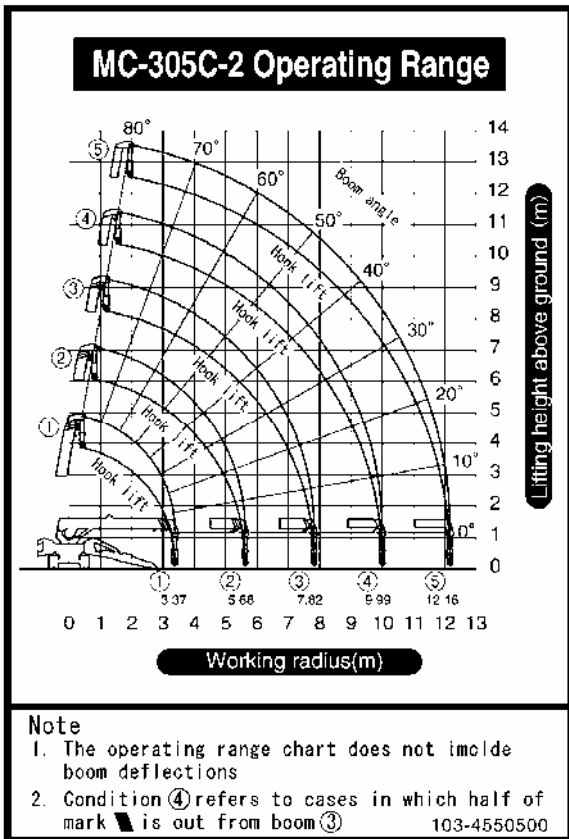

**Hydraulic Oil** 

Only use recommended oil.

**WARNING**

Oil may be extremely hot. To prevent hot oil escaping,

- Stop engine.
- Leave until oil has cooled down.
- When removing cap, partly turn to release pressure before fully removing.

104-4550800

(21) Radiator caution (349-4427300)

**DANGER** 

When radiator is hot, do not open the cap, possibly be burnt or blow up with boiled water.

349-4427300

(22) Fire ban (349-4427500)

**DANGER** 

**CAUTION: INFLAMMABLES**

- Keep off a fire from filling hole.
- While refilling the fuel: engine must stop.

349-4427500

**Fuel: Diesel only**

(23) Diesel fuel caution (553-4267100)

**DIESEL** 

- Drain water from tank in every 50 hours.
- For specified fuel, see Operation Manual.

553-4267100

(24) Rated total load chart (103-3288600)

| MG-305C-2 Rated Total Load Chart   |                                   |  |                          |                       |  |  |  |                     |                    |                          |                       |  |  |  |                     |                    |                          |                       |  |  |
|--|-----------------------------------|--|--------------------------|-----------------------|--|--|--|---------------------|--------------------|--------------------------|-----------------------|--|--|--|---------------------|--------------------|--------------------------|-----------------------|--|--|
| With outrigger extended to maximum   | With outrigger extended to medium | With outrigger extended to minimum             |                          |                       |  |  |  |                     |                    |                          |                       |  |  |  |                     |                    |                          |                       |  |  |
|  |                                   |  |                          |                       |  |  |  |                     |                    |                          |                       |  |  |  |                     |                    |                          |                       |  |  |
| <table border="1"> <tr> <td>Boom 1 and Boon 1+2</td> <td>Working radius (m)</td> <td>2 3 4 5 6 7 8 9 10 11 12</td> </tr> <tr> <td>Rated total load (kg)</td> <td></td> <td>2980 2350 1960 1680 1380 1140 950</td> </tr> </table>   | Boom 1 and Boon 1+2               | Working radius (m)                             | 2 3 4 5 6 7 8 9 10 11 12 | Rated total load (kg) |  | 2980 2350 1960 1680 1380 1140 950              | <table border="1"> <tr> <td>Boom 1 and Boon 1+2</td> <td>Working radius (m)</td> <td>2 3 4 5 6 7 8 9 10 11 12</td> </tr> <tr> <td>Rated total load (kg)</td> <td></td> <td>2980 2350 1960 1680 1380 1140 950</td> </tr> </table>     | Boom 1 and Boon 1+2 | Working radius (m) | 2 3 4 5 6 7 8 9 10 11 12 | Rated total load (kg) |  | 2980 2350 1960 1680 1380 1140 950              | <table border="1"> <tr> <td>Boom 1 and Boon 1+2</td> <td>Working radius (m)</td> <td>2 3 4 5 6 7 8 9 10 11 12</td> </tr> <tr> <td>Rated total load (kg)</td> <td></td> <td>2980 2350 1800 1430 1140 950 790</td> </tr> </table>    | Boom 1 and Boon 1+2 | Working radius (m) | 2 3 4 5 6 7 8 9 10 11 12 | Rated total load (kg) |  | 2980 2350 1800 1430 1140 950 790             |
| Boom 1 and Boon 1+2  | Working radius (m)                | 2 3 4 5 6 7 8 9 10 11 12                       |                          |                       |  |  |  |                     |                    |                          |                       |  |  |  |                     |                    |                          |                       |  |  |
| Rated total load (kg)  |                                   | 2980 2350 1960 1680 1380 1140 950              |                          |                       |  |  |  |                     |                    |                          |                       |  |  |  |                     |                    |                          |                       |  |  |
| Boom 1 and Boon 1+2  | Working radius (m)                | 2 3 4 5 6 7 8 9 10 11 12                       |                          |                       |  |  |  |                     |                    |                          |                       |  |  |  |                     |                    |                          |                       |  |  |
| Rated total load (kg)  |                                   | 2980 2350 1960 1680 1380 1140 950              |                          |                       |  |  |  |                     |                    |                          |                       |  |  |  |                     |                    |                          |                       |  |  |
| Boom 1 and Boon 1+2  | Working radius (m)                | 2 3 4 5 6 7 8 9 10 11 12                       |                          |                       |  |  |  |                     |                    |                          |                       |  |  |  |                     |                    |                          |                       |  |  |
| Rated total load (kg)  |                                   | 2980 2350 1800 1430 1140 950 790               |                          |                       |  |  |  |                     |                    |                          |                       |  |  |  |                     |                    |                          |                       |  |  |
| <table border="1"> <tr> <td>Boom 1+2+3</td> <td>Working radius (m)</td> <td>2 3 4 5 6 7 8 9 10 11 12</td> </tr> <tr> <td>Rated total load (kg)</td> <td></td> <td>2270 2090 1880 1660 1440 1220 1000 880 730 630</td> </tr> </table>   | Boom 1+2+3                        | Working radius (m)                             | 2 3 4 5 6 7 8 9 10 11 12 | Rated total load (kg) |  | 2270 2090 1880 1660 1440 1220 1000 880 730 630 | <table border="1"> <tr> <td>Boom 1+2+3</td> <td>Working radius (m)</td> <td>2 3 4 5 6 7 8 9 10 11 12</td> </tr> <tr> <td>Rated total load (kg)</td> <td></td> <td>2270 2090 1880 1660 1440 1220 1000 880 730 630</td> </tr> </table> | Boom 1+2+3          | Working radius (m) | 2 3 4 5 6 7 8 9 10 11 12 | Rated total load (kg) |  | 2270 2090 1880 1660 1440 1220 1000 880 730 630 | <table border="1"> <tr> <td>Boom 1+2+3</td> <td>Working radius (m)</td> <td>2 3 4 5 6 7 8 9 10 11 12</td> </tr> <tr> <td>Rated total load (kg)</td> <td></td> <td>2270 2090 1660 1270 1120 910 730 670 510 430</td> </tr> </table> | Boom 1+2+3          | Working radius (m) | 2 3 4 5 6 7 8 9 10 11 12 | Rated total load (kg) |  | 2270 2090 1660 1270 1120 910 730 670 510 430 |
| Boom 1+2+3   | Working radius (m)                | 2 3 4 5 6 7 8 9 10 11 12                       |                          |                       |  |  |  |                     |                    |                          |                       |  |  |  |                     |                    |                          |                       |  |  |
| Rated total load (kg)  |                                   | 2270 2090 1880 1660 1440 1220 1000 880 730 630 |                          |                       |  |  |  |                     |                    |                          |                       |  |  |  |                     |                    |                          |                       |  |  |
| Boom 1+2+3   | Working radius (m)                | 2 3 4 5 6 7 8 9 10 11 12                       |                          |                       |  |  |  |                     |                    |                          |                       |  |  |  |                     |                    |                          |                       |  |  |
| Rated total load (kg)  |                                   | 2270 2090 1880 1660 1440 1220 1000 880 730 630 |                          |                       |  |  |  |                     |                    |                          |                       |  |  |  |                     |                    |                          |                       |  |  |
| Boom 1+2+3   | Working radius (m)                | 2 3 4 5 6 7 8 9 10 11 12                       |                          |                       |  |  |  |                     |                    |                          |                       |  |  |  |                     |                    |                          |                       |  |  |
| Rated total load (kg)  |                                   | 2270 2090 1660 1270 1120 910 730 670 510 430   |                          |                       |  |  |  |                     |                    |                          |                       |  |  |  |                     |                    |                          |                       |  |  |
| <table border="1"> <tr> <td>Boom 1+2+3+4</td> <td>Working radius (m)</td> <td>4 5 6 7 8 9 10 11 12</td> </tr> <tr> <td>Rated total load (kg)</td> <td></td> <td>1380 995 880 770 670 570 500 435</td> </tr> </table>   | Boom 1+2+3+4                      | Working radius (m)                             | 4 5 6 7 8 9 10 11 12     | Rated total load (kg) |  | 1380 995 880 770 670 570 500 435               | <table border="1"> <tr> <td>Boom 1+2+3+4</td> <td>Working radius (m)</td> <td>4 5 6 7 8 9 10 11 12</td> </tr> <tr> <td>Rated total load (kg)</td> <td></td> <td>1060 950 860 750 630 490 410 350</td> </tr> </table>                 | Boom 1+2+3+4        | Working radius (m) | 4 5 6 7 8 9 10 11 12     | Rated total load (kg) |  | 1060 950 860 750 630 490 410 350               | <table border="1"> <tr> <td>Boom 1+2+3+4</td> <td>Working radius (m)</td> <td>4 5 6 7 8 9 10 11 12</td> </tr> <tr> <td>Rated total load (kg)</td> <td></td> <td>1060 950 860 680 530 420 340 300</td> </tr> </table>               | Boom 1+2+3+4        | Working radius (m) | 4 5 6 7 8 9 10 11 12     | Rated total load (kg) |  | 1060 950 860 680 530 420 340 300             |
| Boom 1+2+3+4   | Working radius (m)                | 4 5 6 7 8 9 10 11 12                           |                          |                       |  |  |  |                     |                    |                          |                       |  |  |  |                     |                    |                          |                       |  |  |
| Rated total load (kg)  |                                   | 1380 995 880 770 670 570 500 435               |                          |                       |  |  |  |                     |                    |                          |                       |  |  |  |                     |                    |                          |                       |  |  |
| Boom 1+2+3+4   | Working radius (m)                | 4 5 6 7 8 9 10 11 12                           |                          |                       |  |  |  |                     |                    |                          |                       |  |  |  |                     |                    |                          |                       |  |  |
| Rated total load (kg)  |                                   | 1060 950 860 750 630 490 410 350               |                          |                       |  |  |  |                     |                    |                          |                       |  |  |  |                     |                    |                          |                       |  |  |
| Boom 1+2+3+4   | Working radius (m)                | 4 5 6 7 8 9 10 11 12                           |                          |                       |  |  |  |                     |                    |                          |                       |  |  |  |                     |                    |                          |                       |  |  |
| Rated total load (kg)  |                                   | 1060 950 860 680 530 420 340 300               |                          |                       |  |  |  |                     |                    |                          |                       |  |  |  |                     |                    |                          |                       |  |  |
| <table border="1"> <tr> <td>Boom 1+2+3+4+5</td> <td>Working radius (m)</td> <td>4 5 6 7 8 9 10 11 12</td> </tr> <tr> <td>Rated total load (kg)</td> <td></td> <td>730 650 520 430 380 240 310 280 260</td> </tr> </table>  | Boom 1+2+3+4+5                    | Working radius (m)                             | 4 5 6 7 8 9 10 11 12     | Rated total load (kg) |  | 730 650 520 430 380 240 310 280 260            | <table border="1"> <tr> <td>Boom 1+2+3+4+5</td> <td>Working radius (m)</td> <td>4 5 6 7 8 9 10 11 12</td> </tr> <tr> <td>Rated total load (kg)</td> <td></td> <td>730 650 500 410 360 320 290 250 250</td> </tr> </table>            | Boom 1+2+3+4+5      | Working radius (m) | 4 5 6 7 8 9 10 11 12     | Rated total load (kg) |  | 730 650 500 410 360 320 290 250 250            | <table border="1"> <tr> <td>Boom 1+2+3+4+5</td> <td>Working radius (m)</td> <td>4 5 6 7 8 9 10 11 12</td> </tr> <tr> <td>Rated total load (kg)</td> <td></td> <td>730 650 500 410 360 320 290 240 210</td> </tr> </table>          | Boom 1+2+3+4+5      | Working radius (m) | 4 5 6 7 8 9 10 11 12     | Rated total load (kg) |  | 730 650 500 410 360 320 290 240 210          |
| Boom 1+2+3+4+5   | Working radius (m)                | 4 5 6 7 8 9 10 11 12                           |                          |                       |  |  |  |                     |                    |                          |                       |  |  |  |                     |                    |                          |                       |  |  |
| Rated total load (kg)  |                                   | 730 650 520 430 380 240 310 280 260            |                          |                       |  |  |  |                     |                    |                          |                       |  |  |  |                     |                    |                          |                       |  |  |
| Boom 1+2+3+4+5   | Working radius (m)                | 4 5 6 7 8 9 10 11 12                           |                          |                       |  |  |  |                     |                    |                          |                       |  |  |  |                     |                    |                          |                       |  |  |
| Rated total load (kg)  |                                   | 730 650 500 410 360 320 290 250 250            |                          |                       |  |  |  |                     |                    |                          |                       |  |  |  |                     |                    |                          |                       |  |  |
| Boom 1+2+3+4+5   | Working radius (m)                | 4 5 6 7 8 9 10 11 12                           |                          |                       |  |  |  |                     |                    |                          |                       |  |  |  |                     |                    |                          |                       |  |  |
| Rated total load (kg)  |                                   | 730 650 500 410 360 320 290 240 210            |                          |                       |  |  |  |                     |                    |                          |                       |  |  |  |                     |                    |                          |                       |  |  |
| <p>Note:</p> <ol style="list-style-type: none"> <li>Above Rated Total Load Chart is based on level, hard ground. Be careful as your crane may tip over depending on the surface conditions where outrigger is placed.</li> <li>The Rated Total Load Chart is based on practical working radius which includes a bend due to loading. Reckless crane work is dangerous even if the load may be within the range shown in this Chart. Always work safely.</li> <li>Depending on outrigger extension or grounding, tipping over may occur even by lifting rated load.</li> <li>The rated load includes the weight of hook block(30kg).</li> </ol> |                                   |  |                          |                       |  |  |  |                     |                    |                          |                       |  |  |  |                     |                    |                          |                       |  |  |

(25) Remote control receiver plug caution (300-4214000)

## CAUTION

1. To insert plug, hold it in line with receptacle guide, push it in, and tighten screw.
2. To pull plug out, do not pull cord, but pull the plug itself. After removing plug, be sure to cover receptacle with water cap.

(26) Precautions for remote control (104-4548800) (27) No access to crane (349-4422000)

**M A E D A** model MCT300  
**MONITOR DISPLAY**

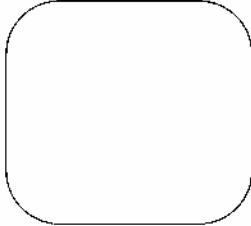

**ERROR CODES**

If a problem is detected one of the following codes will be shown.

| First Code | Trouble   |
|------------|---|
| E1         | Emergency stop activated                            |
| E2         | Receiver or Transmitter unit fault                  |
| E3         | Transmitter internal cable broken                   |
| E4         | For starting transmitter volume position incorrect  |
| E5         | For resetting transmitter volume position incorrect |
| E6         | Problem with receiver EEPROM                        |
| E7         | Problem with receiver CPU                           |
| E9         | For starting transmitter switch position incorrect  |
| E0         | Transmission error                                  |

**CAUTION**

- Be sure to read the instruction manual.
- Modification or disassembly strictly prohibited.
- Have the power supply turned off whenever radio control or remote control is not in use.
- Direct washing prohibited.
- Cover the receptacle with water-tight cap provided whenever remote control is not in use.

104-4548800



349-4422000

(28) Welding ground connection caution (349-4527000)

**CAUTION**

Connect welding ground to frame only.

349-4527000

(29) High temperature caution (349-4427800)

**CAUTION**  **MUFFLER IS HOT**  
 keep your hand off, possibly injure. 349-4427800

(30) Electric shock caution (553-4267300)

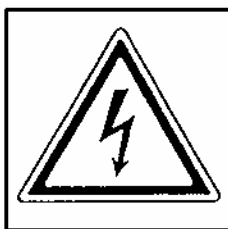

553-4267300

(31) Caution when driving, inspecting or maintaining (893-4239100)

**CAUTION**

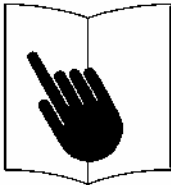

Please be sure to read the manual before starting.

893-4239100

(32) Don't swing counterclockwise when fully lowered (33) Spin turn caution (349-4536600) (349-4420700)



(34) Exhaust gas caution (349-4427400)



(35) Main switch caution (349-4421400)

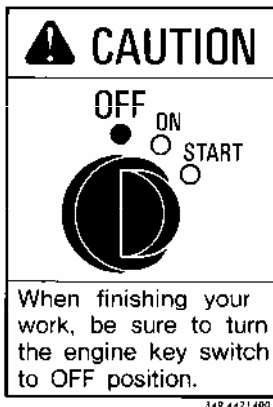

(36) Precaution for crane handling (349-4427100)

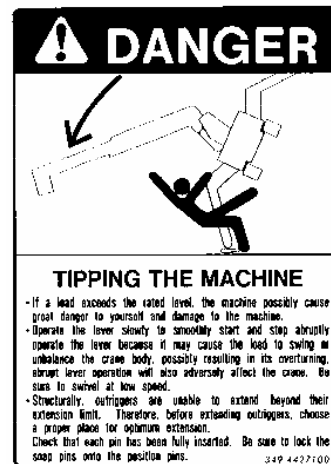

(37) Slope caution (353-4488600)

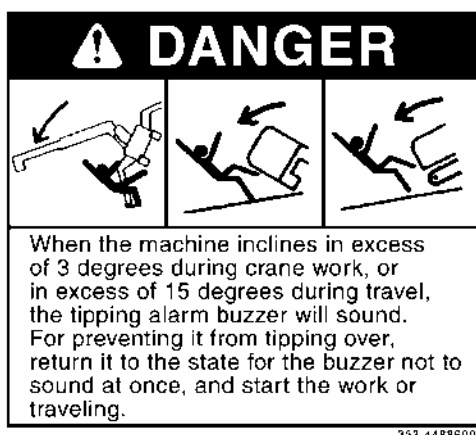

(38) Caution on emergency stop cancel (553-4266400)

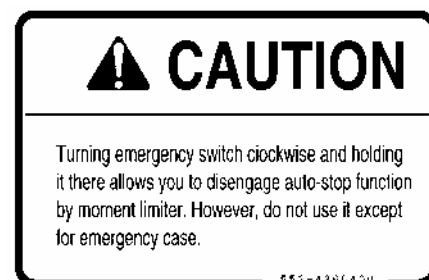

(39) Hook block caution (For hook block) (553-4267400) (2 places)



553-4267400

(40) 4-sling hoisting load (103-4550700) (2 places) (41) 2-sling hoisting load (103-4559200) (2 places)

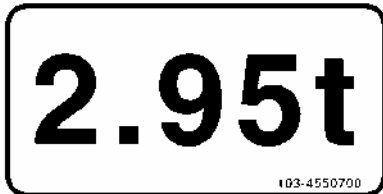

103-4550700

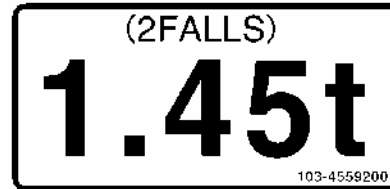

103-4559200

(42) Fire extinguisher caution (103-4604800)

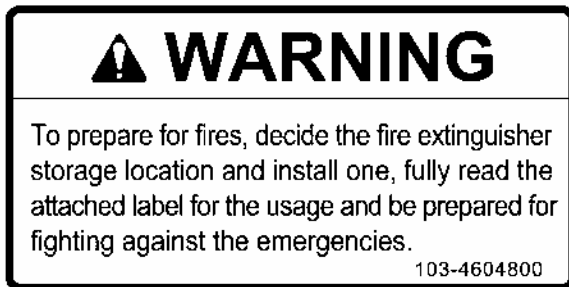

103-4604800

(43) Fuel tank cap caution (103-4604900)

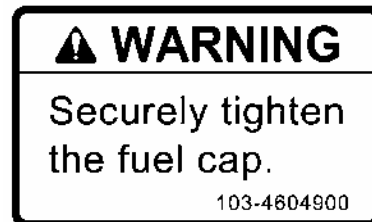

103-4604900

Rear

**CHARACTERISTICS OF PERFORMANCE**

Exam with same work by pulling lifting capability varies depending on the slope of boom to use further slight change in working range is about 1 meter change in the load that can be lifted

2 Lifting capacity of crane reduces as its working radius increases

3 Lifting capacity varies according to the status of outrigger maximum medium or minimum

4 Stability changes depending on the direction of boom forward lateral or backward

**GENERAL RULES FOR USING CRANE**

(1) Before work

- 1 Read the instruction manual carefully before starting to use your crane
- 2 Always perform the pre-inspection inspection
- 3 For crane work be sure to prompt the other workers that the machine is in level
- 4 Make sure all the four outriggers are extended
- 5 Outriggers should be set up to maximum extent or in practice 4
- 6 With the outrigger grounded, especially rubber tracks check the feet of the ground
- 7 Set
- 8 For setting up the outrigger, wait the rotary position and level
- 9 Use care not to catch your finger in the hole
- 10 Check to see the over-hoist alarm system works properly, that buzzer sounds and light set on stop

(2) During work

- 1 Stable lifting load works lifting to outrigger skidding and prevent jarring on crane work with the outrigger locking, raise off the ground, stabilize and should not be performed by sure to observe the Rated Total Load Chart
- 2 Do not perform over-loading operation which may cause slipping over of or other damage to the crane
- 3 Crane work with engine running at high speed is dangerous
- 4 Use care not to allow the load to sway during crane work
- 5 Drugging load laterally (horizontal) or lifting it at an angle may cause the crane and should be avoided
- 6 Do not raise your crane with one hand
- 7 Do not allow anyone to enter under the boom during crane operation
- 8 Use a crane accelerator button, a depressed crane motion will be faster than normal and safety device should be used

(3) During travel

- 1 Do not travel boom and hook and be stored away, respectively
- 2 Be sure to slow down in making turn or traveling over bad road
- 3 For parking or stop be sure to set 4 checks
- 4 For traveling on slope or rough roads be sure to position your arrival on the high end of the slope

(4) After work

Use completion of work be sure to turn off the machine by the

(5) Inspection and service

- 1 Pre-work inspection and service, as well as annual periodical inspection should be carried out regularly
- 2 Defect should be corrected immediately if it found through inspection
- 3 For adjustment of consumables and lubrication, its specification or replacement should be carried out in accordance with the standards as provided in instruction manual or the

**Miscellaneous**

- 1 Improper usage of crane may cause serious accident, including death or severe injury
- 2 Before operating the crane be sure to read instruction manual and learn to safe operating procedure

Front

**MINI-CRAWLER CRANE MC-3050-2**  
MC-3050-2 Rated Total Load Chart

| With outrigger extended to maximum | With outrigger extended to medium |      |      |      |      |      |      |      |      |      |
|------------------------------------|-----------------------------------|------|------|------|------|------|------|------|------|------|
|                                    | 2                                 | 3    | 3    | 4    | 4    | 5    | 5    | 6    | 6    | 6    |
| Rated total load (kg)              | 2340                              | 2380 | 1330 | 1710 | 1490 | 1540 | 1160 | 1160 | 1160 | 1160 |
| Rated total load (kg)              | 2340                              | 2380 | 1330 | 1710 | 1490 | 1540 | 1160 | 1160 | 1160 | 1160 |
| Rated total load (kg)              | 2340                              | 2380 | 1330 | 1710 | 1490 | 1540 | 1160 | 1160 | 1160 | 1160 |
| Rated total load (kg)              | 2340                              | 2380 | 1330 | 1710 | 1490 | 1540 | 1160 | 1160 | 1160 | 1160 |
| Rated total load (kg)              | 2340                              | 2380 | 1330 | 1710 | 1490 | 1540 | 1160 | 1160 | 1160 | 1160 |
| Rated total load (kg)              | 2340                              | 2380 | 1330 | 1710 | 1490 | 1540 | 1160 | 1160 | 1160 | 1160 |
| Rated total load (kg)              | 2340                              | 2380 | 1330 | 1710 | 1490 | 1540 | 1160 | 1160 | 1160 | 1160 |
| Rated total load (kg)              | 2340                              | 2380 | 1330 | 1710 | 1490 | 1540 | 1160 | 1160 | 1160 | 1160 |
| Rated total load (kg)              | 2340                              | 2380 | 1330 | 1710 | 1490 | 1540 | 1160 | 1160 | 1160 | 1160 |

**Operating Range**

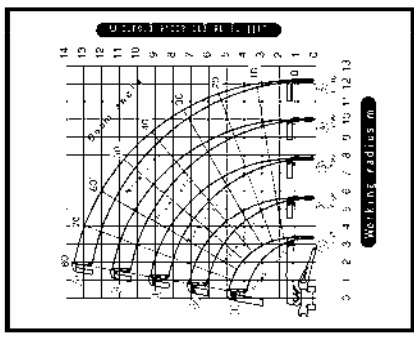

**Note**

- 1 The operating range chart does not include boom deflection
- 2 Capacity decreases to 75% in an extreme wind

| With outrigger extended to minimum | With outrigger extended to maximum |      |      |      |      |      |      |      |      |      |
|------------------------------------|------------------------------------|------|------|------|------|------|------|------|------|------|
| 2                                  | 3                                  | 3    | 4    | 4    | 5    | 5    | 6    | 6    | 6    | 6    |
| Rated total load (kg)              | 1600                               | 1650 | 1650 | 1720 | 1620 | 1570 | 1000 | 1000 | 1000 | 1000 |
| Rated total load (kg)              | 1600                               | 1650 | 1650 | 1720 | 1620 | 1570 | 1000 | 1000 | 1000 | 1000 |
| Rated total load (kg)              | 1600                               | 1650 | 1650 | 1720 | 1620 | 1570 | 1000 | 1000 | 1000 | 1000 |
| Rated total load (kg)              | 1600                               | 1650 | 1650 | 1720 | 1620 | 1570 | 1000 | 1000 | 1000 | 1000 |
| Rated total load (kg)              | 1600                               | 1650 | 1650 | 1720 | 1620 | 1570 | 1000 | 1000 | 1000 | 1000 |
| Rated total load (kg)              | 1600                               | 1650 | 1650 | 1720 | 1620 | 1570 | 1000 | 1000 | 1000 | 1000 |
| Rated total load (kg)              | 1600                               | 1650 | 1650 | 1720 | 1620 | 1570 | 1000 | 1000 | 1000 | 1000 |
| Rated total load (kg)              | 1600                               | 1650 | 1650 | 1720 | 1620 | 1570 | 1000 | 1000 | 1000 | 1000 |
| Rated total load (kg)              | 1600                               | 1650 | 1650 | 1720 | 1620 | 1570 | 1000 | 1000 | 1000 | 1000 |
| Rated total load (kg)              | 1600                               | 1650 | 1650 | 1720 | 1620 | 1570 | 1000 | 1000 | 1000 | 1000 |

**Note**

- 1 Here Rated Total Load Chart is based on the load found by leveling the crane on a level surface
- 2 The Rated Total Load Chart is based on rated capacity of the crane with all outriggers extended to the maximum
- 3 Working on outrigger extends or found as per the safety instruction by the MC-3050-2
- 4 The rated total load chart does not include boom deflection



# 7. WEEE DIRECTIVE LABEL LOCATIONS

Keep these labels clean all the time.

When replacing electrical equipment on which this label is affixed, always apply a new label.

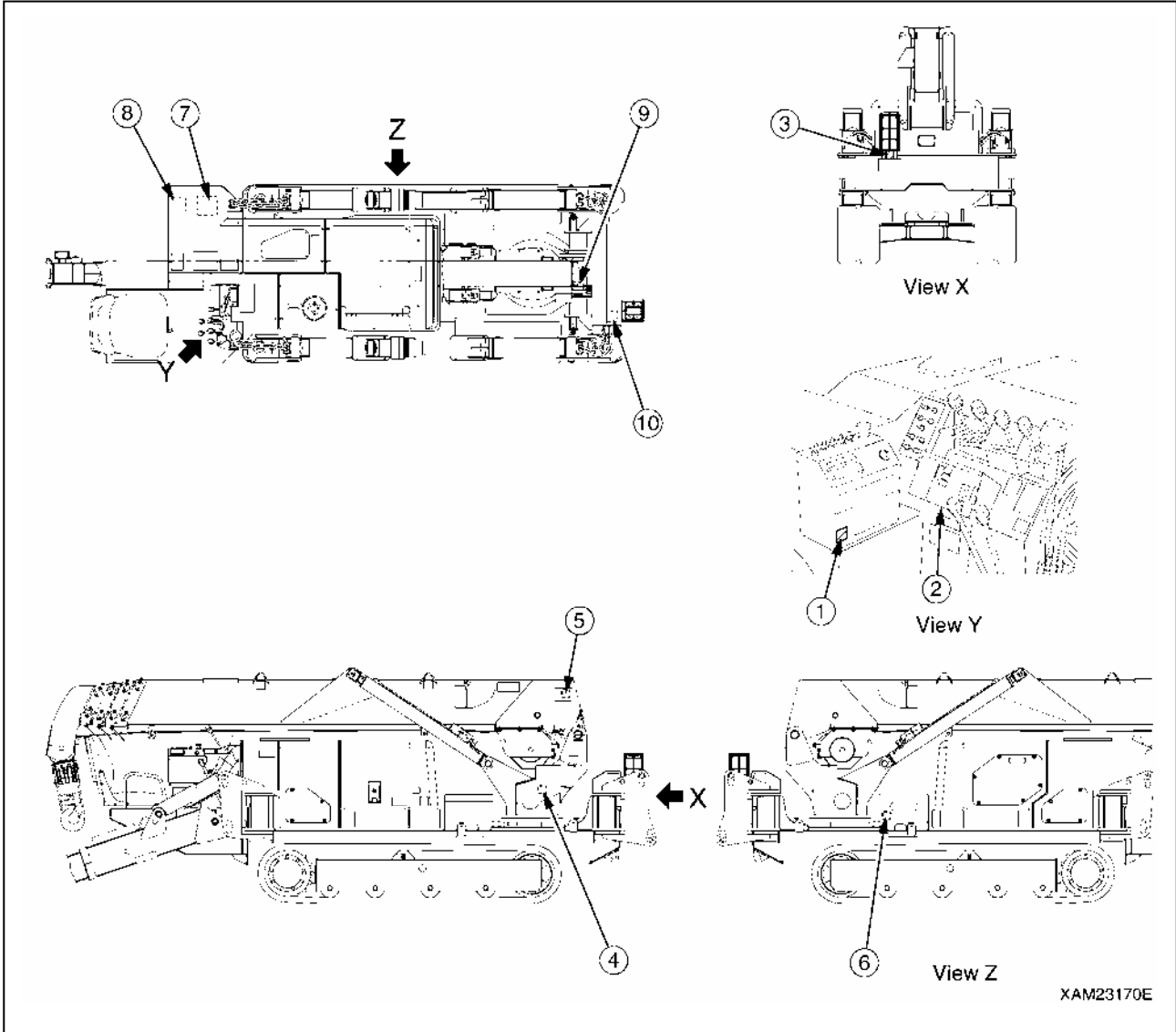

## [WEEE DERECTIVE LABEL (104-4549500)]



## [LOCATIONS OF WEEE DIRECTIVE LABELS]

- (1) Side of the instrument panel
- (2) Side of the moment limiter display
- (3) Lower side of the working status lamp
- (4) Side of the moment limiter converter
- (5) Side of the boom angle detector
- (6) Side of the battery
- (7) Top of the remote-controlled receiver
- (8) Side of the speaker
- (9) Side of the boom length detector
- (10) Side of the inclination sensor
- (11) Side of the remote-controlled transmitter  
(no illustration)

# OPERATION

|                             |       |
|-----------------------------|-------|
| 1. MACHINE EACH SECTION     | 3- 2  |
| 2. OPERATIONS               | 3-40  |
| 3. HANDLING RUBBER TRACKS   | 3-102 |
| 4. HANDLING WIRE ROPES      | 3-106 |
| 5. TRANSPORTATION           | 3-108 |
| 6. HANDLING IN COLD WEATHER | 3-111 |
| 7. LONG-TERM STORAGE        | 3-113 |
| 8. HANDLING BATTERY         | 3-114 |
| 9. TROUBLESHOOTING          | 3-119 |

# 1. MACHINE EACH SECTION

## 1.1 MACHINE EACH UNIT

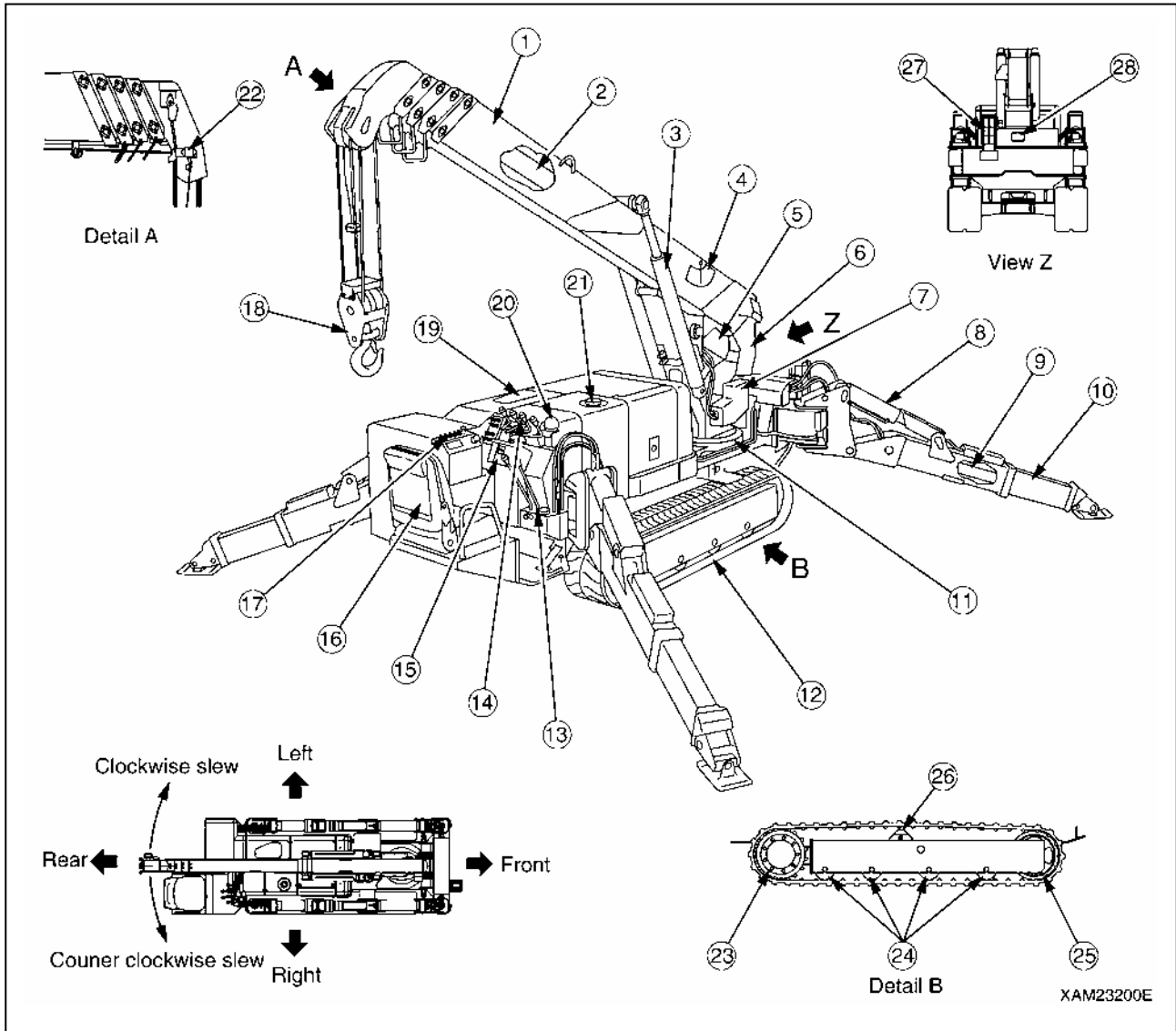

- |   |  |
|---|--|
| (1) Boom  | (15) Moment limiter display unit                 |
| (2) Boom telescoping cylinder (Inside the boom)     | (16) Operation seat                              |
| (3) Boom derricking cylinder                        | (17) Instrument panel                            |
| (4) Load indicator                                  | (18) Hook block                                  |
| (5) Winch   | (19) Hydraulic oil tank (Inside machinery cover) |
| (6) Post  | (20) Outrigger un-set warning lamp               |
| (7) Moment limiter converter                        | (21) Fuel tank (Inside machinery cover)          |
| (8) Outrigger setting cylinder                      | (22) Over hoist detector                         |
| (9) Outrigger extension cylinder (Built in the box) | (23) Traveling motor and sprocket                |
| (10) Outrigger                                      | (24) Track roller                                |
| (11) Slewing device                                 | (25) Idler                                       |
| (12) Rubber track                                   | (26) Carrier roller                              |
| (13) Traveling operation unit                       | (27) Working status lamp                         |
| (14) Crane operation unit                           | (28) Headlight                                   |

## 1.2 TRAVELING AND CRANE OPERATION UNITS

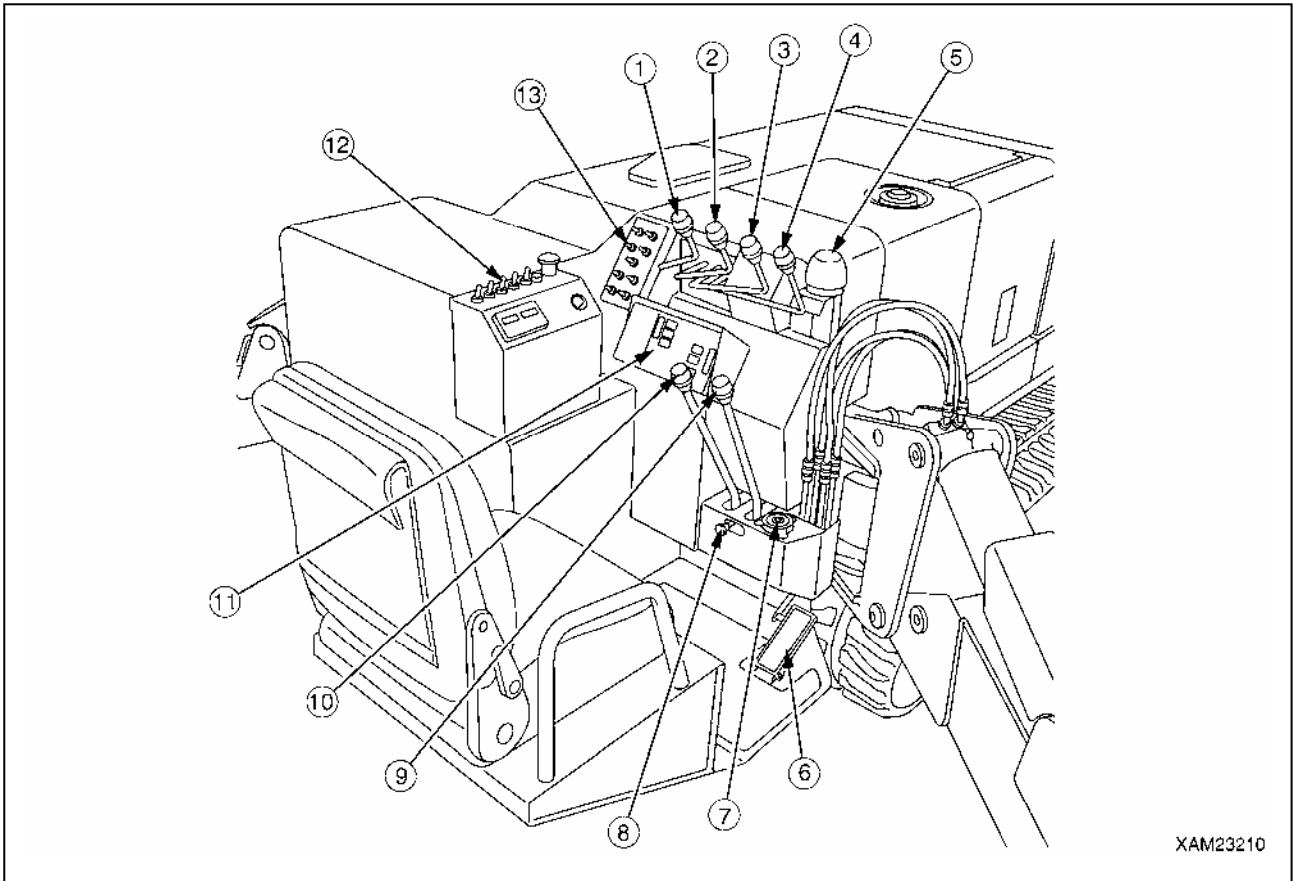

XAM23210

- (1) Slewing lever
- (2) Boom telescoping lever
- (3) Winch lever
- (4) Boom derricking lever
- (5) Outrigger un-set warning lamp
- (6) Acceleration pedal
- (7) Level
- (8) Traveling lock lever
- (9) Right traveling lever
- (10) Left traveling lever
- (11) Moment limiter display panel
- (12) Instrument panel
- (13) Outrigger operation panel

### [1] ACCELERATION PEDAL (6)

Use the pedal to adjust the engine speed or output.

- Low idling: Release your foot from the pedal.
- Full speed: Press down fully on the acceleration pedal.

#### NOTES

Press down on the acceleration pedal to the position necessary for the work.

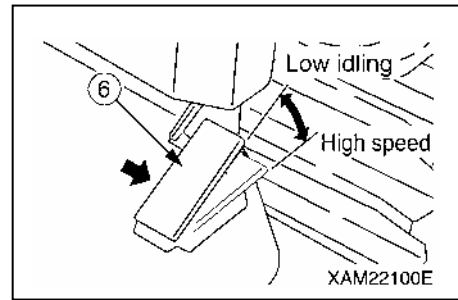

### [2] SLEWING LEVER (1)

Use the lever to slew the crane boom and post.

- Slew counter clockwise: Press the lever forward (Left).
- Neutral: Release your hand from the lever.

The lever returns to the "NEUTRAL" position and the slewing stops.

- Slew clockwise: Pull the lever toward you (Right).

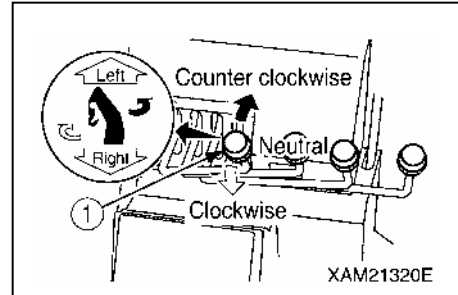

### [3] BOOM TELESCOPING LEVER (2)

Use this lever for telescoping the crane boom.

- Extend: Push the lever forward (Extend).
- Neutral: Release your hand from the lever.

The lever returns to the "NEUTRAL" position and the boom telescoping stops.

- Retract: Pull the lever toward you (Retract).

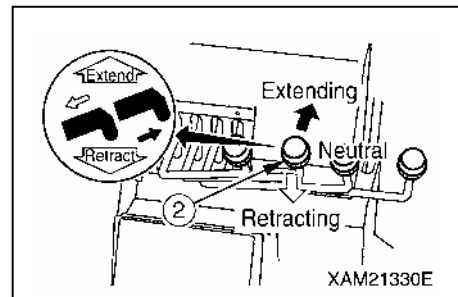

### [4] WINCH LEVER (3)

Use this lever to raise/lower the hook block of the crane.

- Lower: Push the lever forward (Down).
- Neutral: Release your hand from the lever.

The lever returns to the "NEUTRAL" position and the machine automatically brakes. The lowering/raising of the hook block stops.

- Raise: Pull the lever toward you (Up).

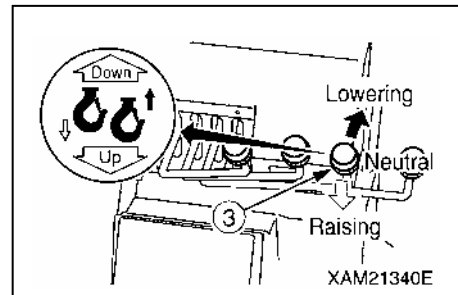

### [5] BOOM DERRICKING LEVER (4)

Use this lever to raise/lower the hook block of the crane.

- Lower: Push the lever forward (Lower).
- Neutral: Release your hand from the lever.

The lever returns to the "NEUTRAL" position and the boom derricking stops.

- Raise: Pull the lever toward you (Raise).

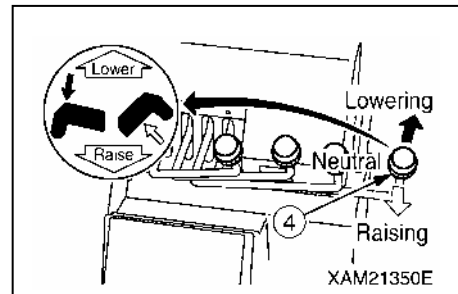

### [6] TRAVELING LOCK LEVER (8)

Use this lever to “lock” the traveling levers.

- Lock: Push the lever to the right.
- Travel: Push the lever to the left.

#### NOTES

Operate the traveling lock lever while the left and right traveling levers are at the “NEUTRAL” position.

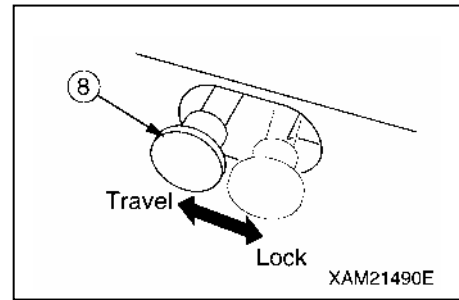

### [7] LEFT/RIGHT TRAVELING LEVER (9), (10)

Use these levers to move the machine forward/backward, stop, slew, and to adjust the traveling speed.

- Forward: Push the left and right levers forward at the same time.
- Neutral: Release your hands from left and right levers at the same time. The levers return to the “NEUTRAL” position and the machine automatically brakes and stops at that position.
- Backward: Pull the left and right levers toward you at the same time.
- Left turn: Release your hand from the left lever and operate the right lever forward or backward.
- Right turn: Release your hand from the right lever and operate the left lever forward or backward.
- Spin turn: Operate the left and right levers to the opposite direction. The left and right crawlers turn to the opposite direction, allowing you to make the spin turn.

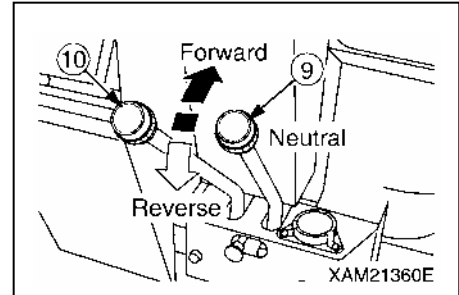

### [8] LEVEL

#### ⚠ WARNING

When installing the outrigger, make adjustments while looking at the level so that the machine body will be leveled. Performing the crane operation with the body tilted will cause overturning.

This device indicates how much the machine body is tilted.

The bubble position shows how much the machine is tilted in which direction.

Use this device to verify that the machine is leveled when setting the outriggers.

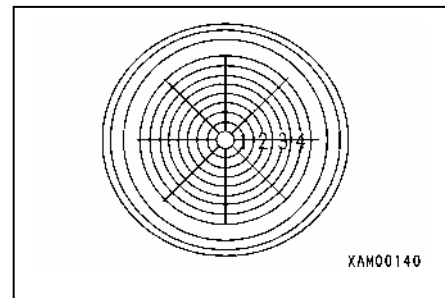

### [9] OUTRIGGER UN-SET WARNING LAMP (Red)

The lamp flashes if one of the four outriggers is not set properly.

#### NOTES

- If the extension or setting of one of the four outriggers cannot be detected, the outrigger un-set warning lamp flashes.
- The outrigger un-set warning lamp is linked with the working status lamp for moment limiter (red). As the outrigger un-set warning lamp flashes, the working status lamp (red) also rotates and lights up.

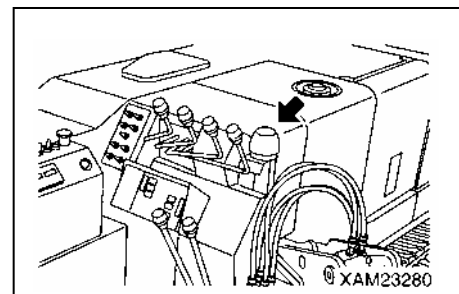

### 1.3 INSTRUMENT PANEL SECTIONS

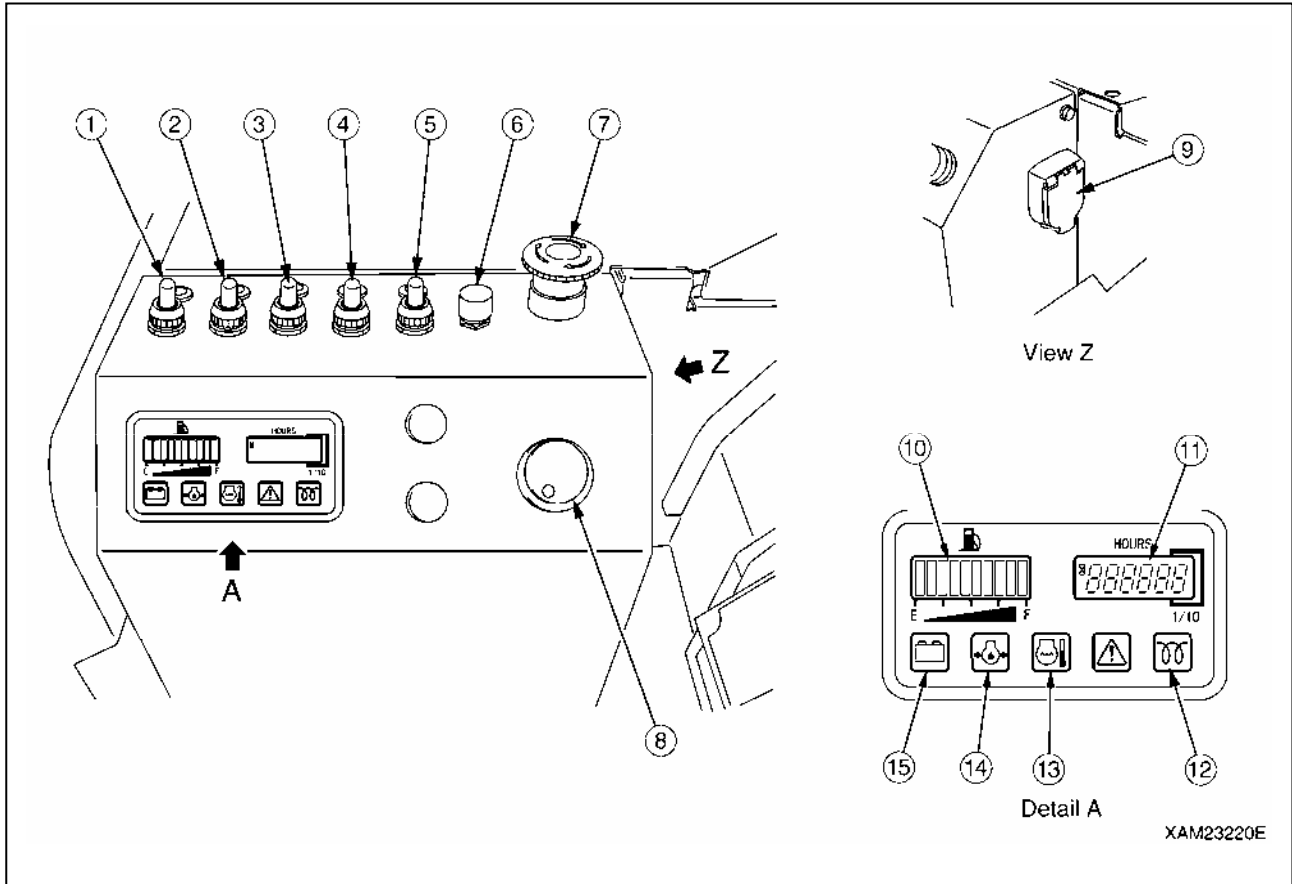

- (1) Headlight switch
- (2) Crane high-speed switch
- (3) Hook stowing switch
- (4) Traveling high-speed switch
- (5) Boom stowing switch
- (6) Horn switch
- (7) Engine emergency stop switch
- (8) Starter switch

- (9) Emergency stop cancel switch
- (10) Fuel gauge
- (11) Hour meter
- (12) Pre-heat monitor
- (13) Engine water temperature monitor
- (14) Engine oil pressure monitor
- (15) Battery charge monitor

### 1.3.1 DESCRIPTION OF EACH SWITCHES

#### [1] STARTER SWITCH

##### **⚠ CAUTION**

Always turn the starter switch to the "OFF" position after completing the work.

##### **NOTES**

When inserting the key for the starter switch, slide the cover to the left so that you can see the keyhole of the switch, and then insert the key.

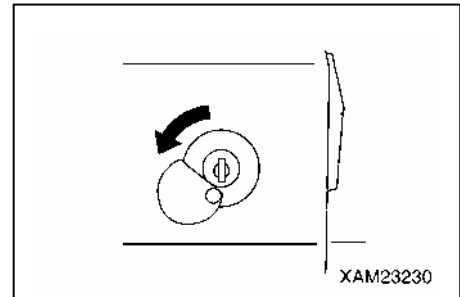

Use this switch to start and stop the engine.

- HEAT : Turn the key to this position when starting the engine in the cold weather.
- OFF : You can insert/remove the key at this position. All the switches in the electrical system are turned off and the engine stops.
- ON : Electricity runs into all the circuits.
- START: When the engine has started, release your hand from the key. The key automatically returns to the "ON" position.

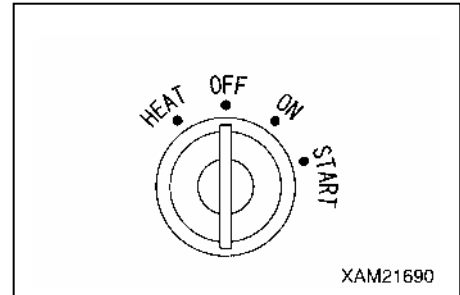

#### [2] HEADLIGHT SWITCH

Use this switch to turn on the headlights on front of the machine. The pilot lamp at the switch section lights up when the switch is set to the "ON" position and extinguishes at the "OFF" position.

- ON: Push the switch forward. The headlights turn on.
- OFF: Push the switch toward you. The headlights turn off.

##### **NOTES**

The headlights do not light up even if the headlight switch is operated when the starter switch is at the "OFF" position.

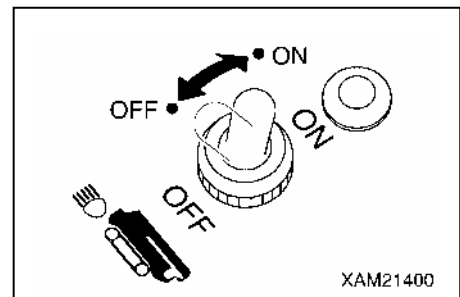

#### [3] CRANE HIGH-SPEED SWITCH

Use this switch to change the operating speed of the crane during the crane operation.

The pilot lamp at the switch section lights up when the switch is operated to the "ON" position and extinguishes at the "OFF" position.

- ON: Push the switch forward, and when the pilot lamp lights up the switch turns "ON" and the crane operating speed increases.
- OFF: Push the switch forward again, and when the pilot lamp goes off the switch turns "OFF" and the crane operating speed returns to normal.

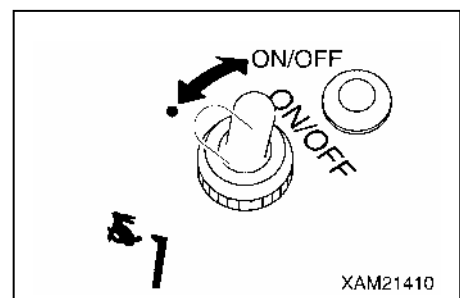

##### **NOTES**

Always set the work selector switch on the outrigger operation panel to the "CRANE" position. If the work selector switch is at other position than "CRANE", the crane high-speed switch does not work.



#### [4] HOOK STOWING SWITCH

### ⚠ WARNING

- The hook stowing switch cancels the auto-stop function of the over hoist detector. Operate the winch lever carefully when stowing the hook block. Pay sufficient attention not to let the hook block collide with the boom.
- Use this switch only when stowing the hook block.

Use this switch to stow the hook block at the tip of the boom. The pilot lamp at the switch section lights up when the switch is operated to the “ON” position and extinguishes at the “OFF” position.

- ON: Keep pushing the switch forward and operate the winch lever to “RAISE” side. The hook block is raised and can be stowed in the tip of the boom.
- OFF: Release your finger from the switch. The switch returns to the original position and the auto-stop function of the over hoist detector will be activated.

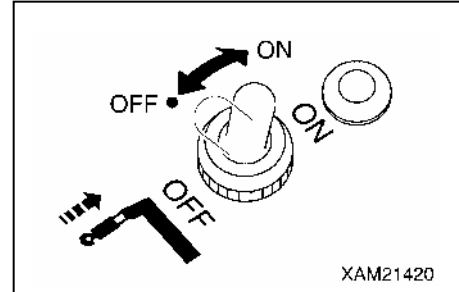

#### [5] TRAVELING HIGH-SPEED SWITCH

### NOTES

It may be difficult to change the direction in the high-speed traveling mode. In that case, switch to the low-speed traveling mode.

Use this switch to change the mode of the machine traveling speed. The pilot lamp at the switch section lights up when the switch is operated to the “ON” position and extinguishes at the “OFF” position.

- ON: Push the switch forward. The traveling speed mode changes to high-speed traveling mode.
- OFF: Push down the switch toward you. The traveling speed mode changes to low-speed traveling mode.

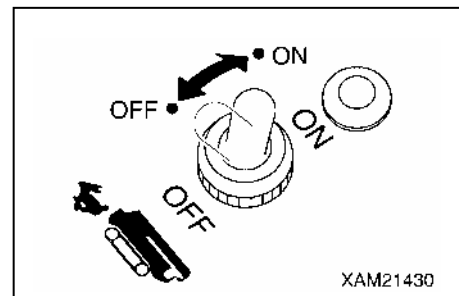

#### [6] BOOM STOWING SWITCH

### ⚠ WARNING

- The boom stowing switch cancels the auto-stop function of the lower-limit detecting interlock device during the boom “lowering” operation. Operate the boom derricking lever carefully when stowing the boom. Pay sufficient attention not to let the boom collide with the machine body.
- Use the boom stowing switch only when stowing the boom.

Use this switch to stow the boom.

The pilot lamp at the switch section lights up when the switch is set to the “ON” position and extinguishes at the “OFF” position.

- ON: Keep pushing the switch forward and operate the boom derricking lever to “LOWER” side. The boom lowers and can be stowed.
- OFF: Release your finger from the switch. The switch returns to the original position and the auto-stop function of the lower-limit detecting interlock device will be activated.

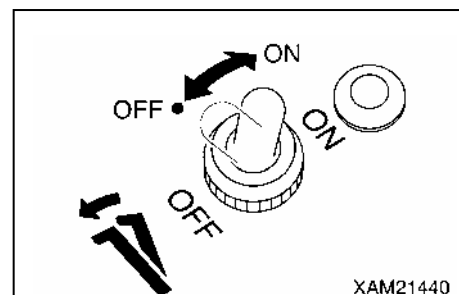

### [7] HORN SWITCH

Use this switch to honk the horn.

- Honking the horn: Press the switch.

#### NOTES

The horn will stop when you release your finger from the switch.

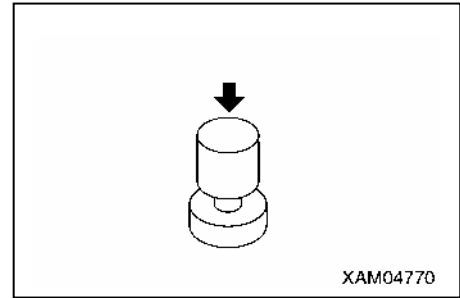

XAM04770

### [8] ENGINE EMERGENCY STOP SWITCH

Use this switch in case of an error in the machine to stop the machine for emergency.

- ON: Press the switch. The engine stops.
- OFF: Turn the switch clockwise (direction of the arrow in the right figure). The switch returns to the original position.

#### NOTES

When restarting the engine after emergency stop, be sure to turn the engine emergency stop switch to the "OFF" position before starting the engine.

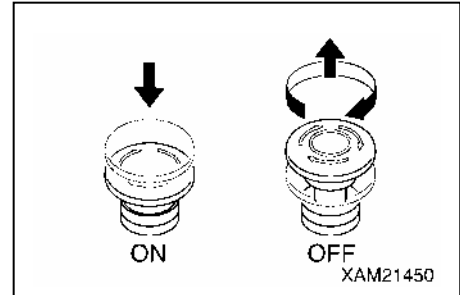

XAM21450

### [9] EMERGENCY STOP CANCEL SWITCH

#### **⚠ DANGER**

- **Do not set the emergency stop cancel switch to ON (cancel) position during crane work. Such attempt prevents automatic stop from occurring even under overwound condition during crane work, thus may not only cause the hoisted load to collide and damage crane parts but may cause the load to drop and cause a serious accident or cause the machine to tip over. Keep the switch key extracted during normal crane works.**
- **Do not turn the emergency stop cancel switch to the "ON" (cancel) position when stowing the hook. The winch wire rope may be cut causing the hook to fall or damage on the boom. Use the hook stowing switch when stowing the hook.**
- **Do not turn ON (cancel) the emergency stop cancel switch unless you find an error or check/perform maintenance on detectors. When turning ON (cancel) the emergency stop cancel switch, always shift the crane speed to low.**

Use the emergency stop cancel switch as needed when performing inspection or maintenance to clear the activation stop. Open the cover when using the switch.

- ON (Clear): Insert the key into the switch. Turn the key clockwise and retain the key at that position. The activation stop function is cleared while the key is maintained at the ON position.
- OFF (Auto): Insert the key into the switch and turn the key counterclockwise. The activation stop functions. The key can be removed or inserted at this position.

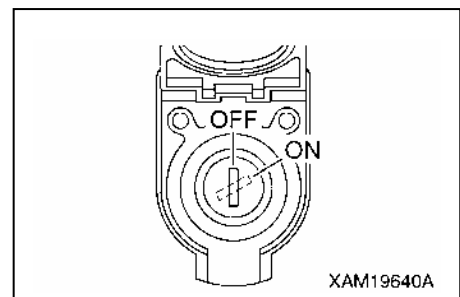

XAM19640A

### 1.3.2 DESCRIPTION OF EACH MONITORS

#### ⚠ CAUTION

If the monitor flashes during the work, stop the operation immediately and check, adjust, or repair the relevant section.

#### [1] FUEL GAUGE

This gauge indicates the remaining amount of the fuel in the fuel tank.

Turn the starter switch to the "ON" position and the gauge indicates the remaining amount of the fuel with the "bar".

When only one "bar" lights up on the "E" side, there is not much fuel left.

Stop the operation immediately and refuel.

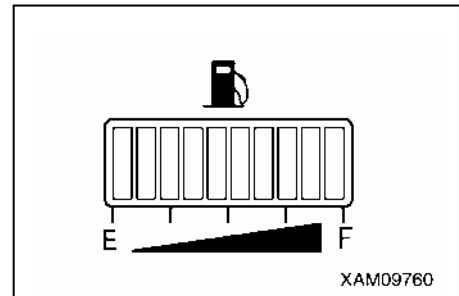

#### NOTES

- At the end of a day, fuel to full (until all the "bar"s (10 bars) light up.)
- The remaining amount indicated may not be correct for a while after the starter switch is turned to the "ON" position. This is normal.

#### [2] HOUR METER

This meter shows the total running hours of the machine.

Use this value as the reference for periodical check interval.

If the engine is in operation, the meter indication advances even if the machine is not moving.

The meter indication advances for "1" when the machine has been running for 1 hour regardless of the engine rotation speed.

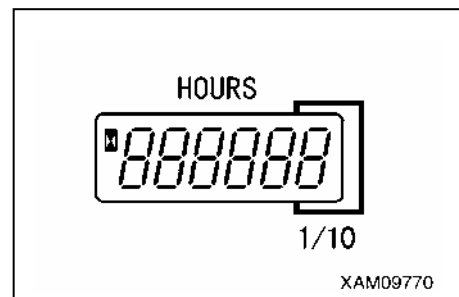

#### [3] PREHEAT MONITOR

The monitor lights up during the preheating operation when starting the engine.

It lights up when the starter switch is operated to the "HEAT" (preheat) position and goes off in several seconds to indicate the completion of preheating.

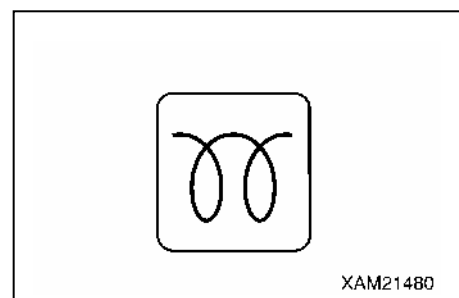

#### [4] ENGINE WATER TEMPERATURE MONITOR

This monitor indicates errors with the engine cooling water temperature.

The temperature is normal if this monitor is OFF during the operation.

If it lights up during the operation, it means that the engine cooling water temperature exceeded the normal temperature.

Promptly switch the engine rotation to low idling and wait until the monitor goes off (engine cooling water temperature goes down).

Then, stop the operation and check the water leakage from the radiator, clogging in the radiator core, and damage and tension of the alternator belt.

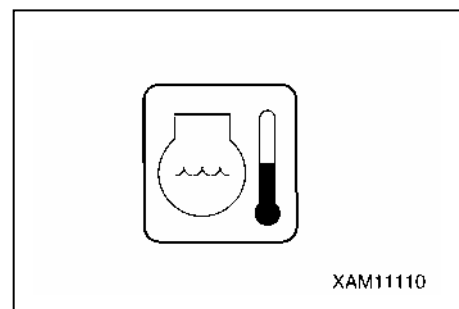

### [5] ENGINE OIL PRESSURE MONITOR

This monitor indicates the drop in the engine oil pressure.

If it lights up when the starter switch is turned to the "ON" position and goes off as the engine rotation increases after the engine is started, the engine oil pressure is normal.

If it lights up during the operation, the engine oil pressure has dropped.

Immediately stop the machine and check the clogging of the engine oil filter and engine lubricant level.

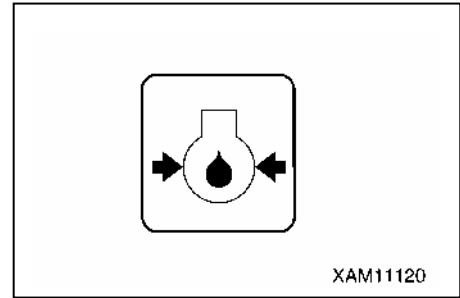

### [6] BATTERY CHARGE MONITOR

This monitor indicates errors in the battery charge system.

If it lights up when the starter switch is turned to the "ON" position and goes off as the engine rotation increases after the engine is started, the battery charge system is normal.

If it lights up during the operation, there is an error in the battery charge system.

Immediately stop the machine and check the tension of the alternator belt.

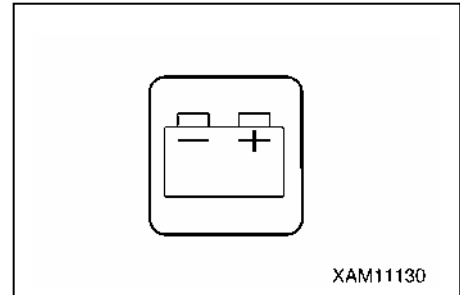

### 1.3.3 DESCRIPTION OF FUSES

#### ⚠ CAUTION

Be sure to turn the starter switch to the “OFF” position when checking or replacing a fuse.

#### CAUTION

Fuses protect electrical components and wires from being burnt out.

- Fuses are blade fuses. If a fuse was corroded and shows white powder, be sure to change the fuse.
- If a fuse has melt down, always check the cause in the circuit and repair the problem before changing the fuse.
- Always use a fuse of the same capacity when replacing one.

The fuse box is provided at the lower section of the instrument panel.

Check and replace a fuse using the procedure below.

1. Remove the buckle (2) of the cover (1) at the bottom of the instrument panel to open the cover (1).

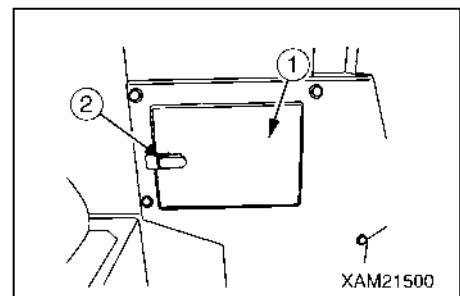

2. Remove the cover (3) of the fuse box.

3. Remove the fuse from the fuse box and check/replace the fuse.

4. Insert a new or checked fuse to the original position in the fuse box.

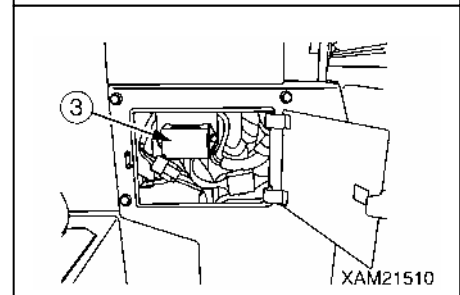

#### [FUSE CAPACITY AND CIRCUIT NAMES]

The table below shows the fuse system and its capacity.

| Index | Capacity | Circuit Name                      |
|-------|----------|-----------------------------------|
| A     | 10 A     | Main P.S.                         |
| B     | 10 A     | PCB                               |
| C     | 10 A     | Engine control                    |
| D     | 10 A     | Solenoid valve                    |
| E     | 10 A     | Horn, light                       |
| F     | 20 A     | Moment limiter, remote controller |
| G     | 20 A     | Spare                             |
| H     | 10 A     | Spare                             |
| I     | 10 A     | Spare                             |

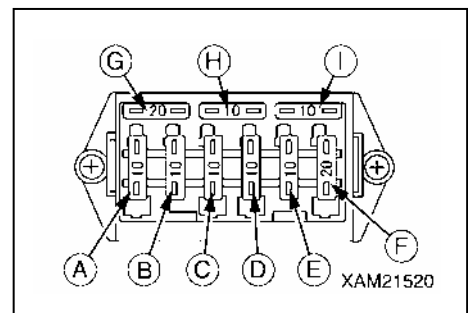

## 1.4 OUTRIGGER OPERATION PANEL

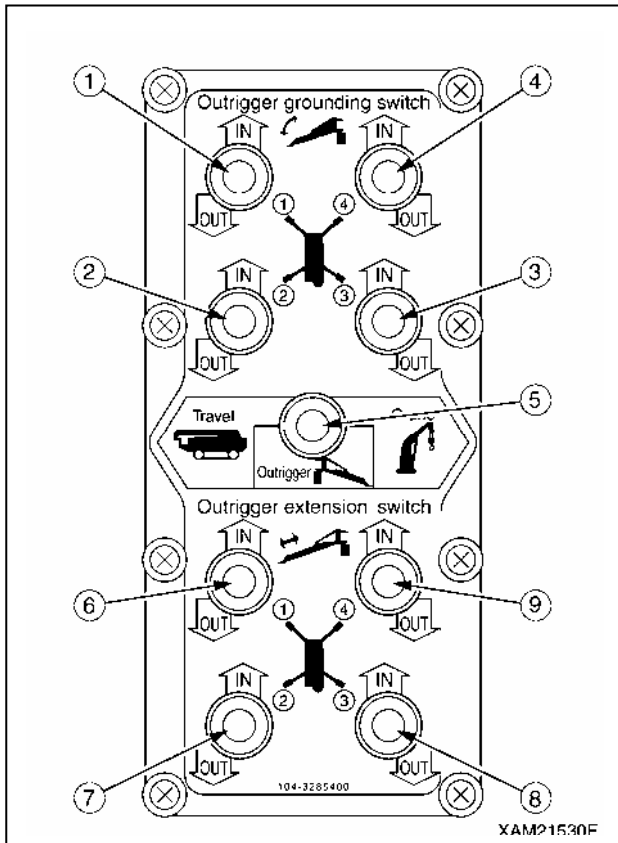

- (1) Outrigger (1) setting switch
- (2) Outrigger (2) setting switch
- (3) Outrigger (3) setting switch
- (4) Outrigger (4) setting switch
- (5) Work selector switch  
(TRAVEL, OUTRIGGER, CRANE)
- (6) Outrigger (1) extension switch
- (7) Outrigger (2) extension switch
- (8) Outrigger (3) extension switch
- (9) Outrigger (4) extension switch

### [1] WORK SELECTOR SWITCH (TRAVEL, OUTRIGGER, CRANE)

#### ⚠ WARNING

- When operating the work selector switch to the “TRAVEL” position, be sure to stow the crane and put the machine in the “traveling posture”. Driving the machine not in the “traveling posture” can overturn the machine, resulting in serious accidents.
- Be sure to operate the traveling lock lever to the “LOCK” position before outriggering or crane operation.  
Note that if the traveling lock lever is not at the “LOCK” position, you can still travel the machine even if the work selector switch is operated to the “OUTRIGGER” or “CRANE” position. Be careful not to let your hand or body touch the traveling levers. The machine may move, causing serious accidents.
- Be sure to set all the outriggers when turning the work selector switch to the “CRANE” position to perform the crane operation. Inappropriate setting of outriggers will prevent the crane operation because of the outrigger safety device function.
- Always stow the boom when performing the outrigger operation with the work selector switch set to the “OUTRIGGER” position. If the boom is not stowed properly, the outrigger safety device function prevents the outrigger operation from being performed.

Use this switch to switch the work state of the machine (“TRAVEL”, “OUTRIGGER”, “CRANE”).

- Travel: Push down the switch to the left. Now you can travel the machine.
- Outrigger: Push down the switch to the center position. Now you can perform the outrigger operation.
- Crane: Push down the switch to the right. Now you can perform the crane operation.

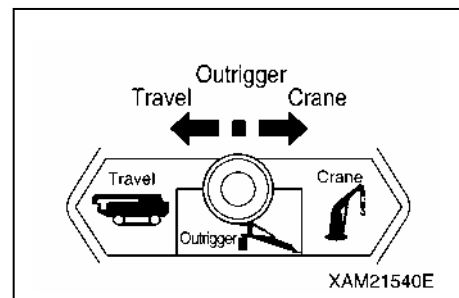

## NOTES

The table below shows the relation between the operation position of the work selector switch and permitted operations.

- Only the traveling operation is active when the work selector switch is at the “TRAVEL” position.
- When the work selector switch is at the “OUTRIGGER” position, all the devices in the table below are active.

Be sure to set the traveling lock lever to the “LOCK” position and stow the crane when operating the outriggers. Be careful not to touch the operation levers of the crane.

- When the work selector switch is at the “CRANE” position, all the devices except for outrigger operation in the table below are active.

Be sure to set the traveling lock lever to the “LOCK” position and set all the outriggers when operating the crane.

| Work Selector<br>Switch Operation<br>Position | Crane System (A: Active N: Not active) |                        |                    |                   |            |                    |
|---|--|------------------------|--------------------|-------------------|------------|--------------------|
|   | Traveling<br>Operation                 | Outrigger<br>Operation | Crane<br>Operation | Remote Controller |            | Moment<br>Limiters |
|   |  |                        |                    | Crane             | Outrigger  |                    |
| TRAVEL  | A                                      | N                      | N                  | N                 | N          | N                  |
| OUTRIGGER                                     | N (Note 1)                             | A                      | N                  | N                 | A          | A                  |
| CRANE   | N (Note 1)                             | N                      | A                  | A                 | A (Note 2) | A                  |

Note 1: Operating the traveling lock lever to the “LOCK” side restricts the traveling operation.

If the lever is not operated to the “LOCK” side, the machine travels when a traveling lever is operated.

Note 2: The outrigger operation is enabled only when the transmitter of the remote controller is in the

### [2] OUTRIGGER SETTING SWITCHES

Use these switches to set or stow the outriggers.

There are four outriggers ((1) to (4)). Each outrigger can be operated independently or all together.

- IN : Push down the switch upward. The outrigger setting cylinder retracts and you can stow the outrigger.
- Neutral: Release your finger from the switch. The switch returns to the “NEUTRAL” position and the outrigger setting cylinder stops telescoping.
- OUT: Push down the switch downward. The outrigger setting cylinder extends and you can set the outrigger.

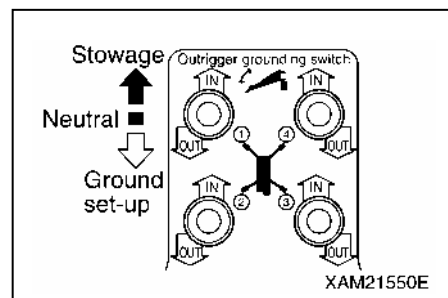

### [3] OUTRIGGER EXTENSION SWITCH

Use these switches to extend or stow the outriggers.

There are four outriggers ((1) to (4)). Each outrigger can be operated independently or all together.

- IN : Push down the switch upward. The outrigger extension cylinder retracts and you can stow the outrigger inner box.
- Neutral: Release your finger from the switch. The switch returns to the “NEUTRAL” position and the outrigger extension cylinder stops telescoping.
- OUT: Push down the switch downward. The outrigger extension cylinder extends and you can extend the outrigger.

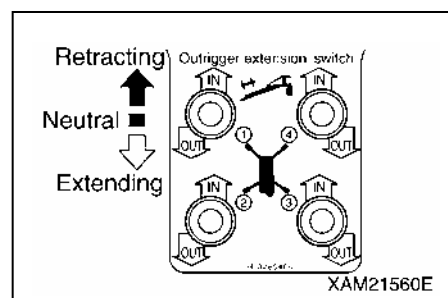

## 1.5 OUTRIGGER SAFETY DEVICES

### 1.5.1 FUNCTIONS OF OUTRIGGER SAFETY DEVICES

The outrigger safety devices have the interlock functions shown in the table below.

|   | Interlock Function  | Description of Interlock Function   |
|---|---------------------|---|
| 1 | Outrigger Interlock | <p>The outrigger is not enabled if the position pin is not inserted properly by rotating the outrigger rotary to extension side (outward) with the boom being stowed (boom lowered to maximum, slewed and stored).</p> <ul style="list-style-type: none"> <li>• Whether the boom is lowered to the maximum is verified by the detection switch located to the post.</li> <li>• Install a protrusion on the post at the boom slew and stow position and a detector switch on the traveling dolly in order to detect whether the boom has stopped at the slew and stow position.</li> </ul>   |
| 2 | Crane Interlock     | <p>The crane operation (telescoping, raising/lowering hook, derricking, and slewing) is enabled only when all the four outriggers are extended and set (overhung and grounded).<br/>The outrigger extension status is detected as follows.</p> <ul style="list-style-type: none"> <li>• Install a detection switch at the position pin section of the outrigger rotary to detect the insertion of the position pin into the extension position.</li> <li>• Install a detection switch inside the outrigger inner box to detect if the tray is seated properly through the detection pin installed between the tip of the inner box and the tray.</li> </ul> |

### CAUTION

- **Set the outriggers in the extension status and operate the work selector switch in the outrigger operation panel to the “CRANE” position to enable the crane operation.**  
**When the detection condition for setting one of the four outriggers (see the item 2 in the table above) is no more fulfilled, the working status lamp (red) rotates and lights up, and outrigger un-set warning lamp (red) flashes.**  
**If this state remains for 3 seconds or more, the crane interlock function is activated and the crane operation will be disabled.**
- **Stow the crane and operate the work selector switch on the outrigger operation panel to the “OUTRIGGER” position to enable the outrigger setting and extension operations.**
- **If the crane operation is not enabled after operating the work selector switch on the outrigger operation panel to the “CRANE” position even after the outrigger is being extended and set, there may be faulty adjustment or failure in the outrigger safety device.**  
**Please ask us or our sales service agency for repair.**



## 1.5.2 NAMES AND DESCRIPTIONS OF OUTRIGGER DISPLAY

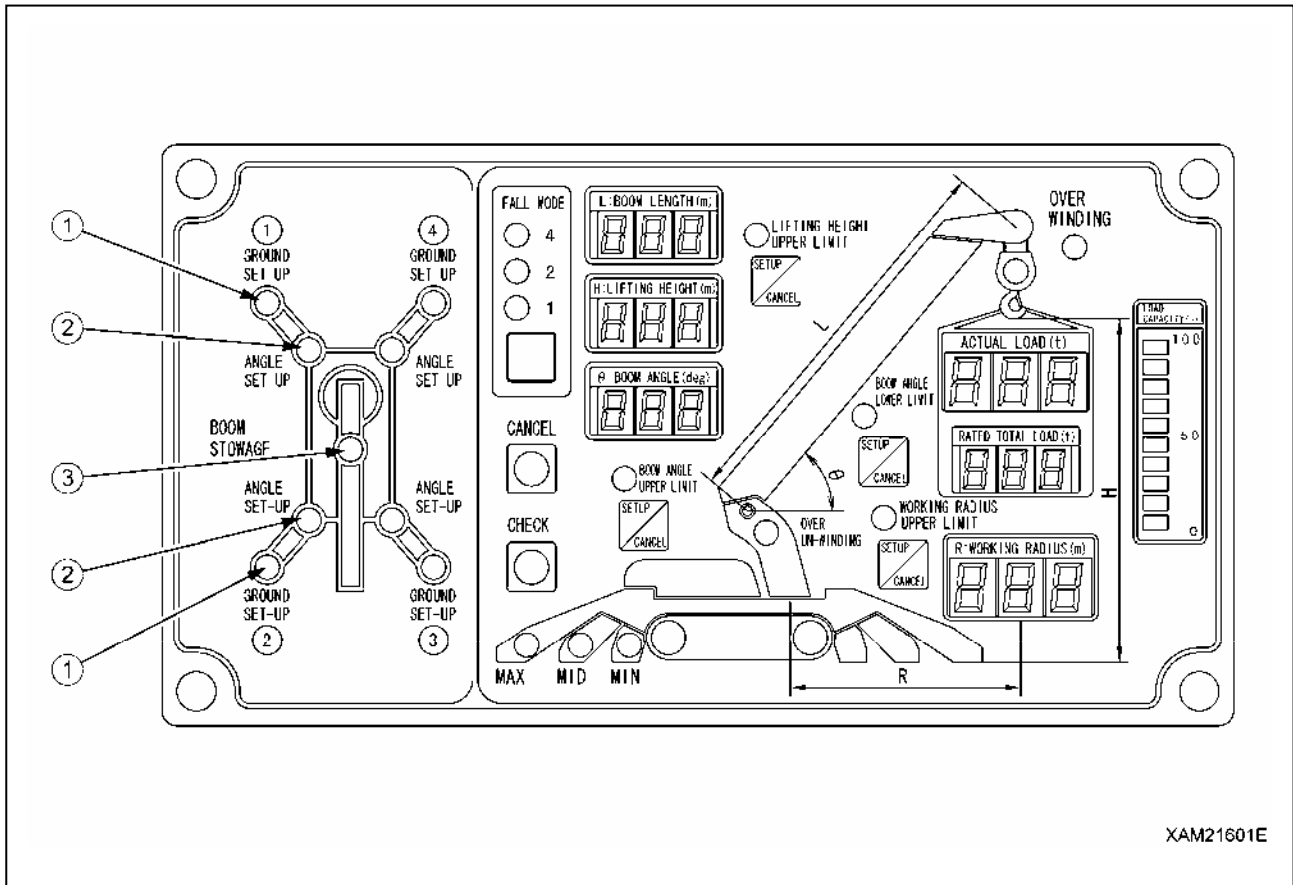

- (1) Outrigger setting lamp
- (2) Outrigger extension lamp
- (3) Boom stowing lamp

### **⚠ WARNING**

- Do not remove, disassemble, or repair detection switches. Do not move the detection switches from the original location to another.
- If you hit detection switches or found damage on the detection switches, be sure to check the ON/OFF operation of the lamps on the outrigger display and operation of the crane interlock function and outrigger interlock function. If you find any error, ask us or our sales service agency for repair.

### [1] OUTRIGGER EXTENSION LAMPS

The lamp turns on to indicate that the outrigger is extended.

Turns on when the position pin (2) is inserted (extension), and turns off when extracted (stow).

The extraction/insertion of the position pin (2) is detected by the detection switch (1) of the outrigger rotary.

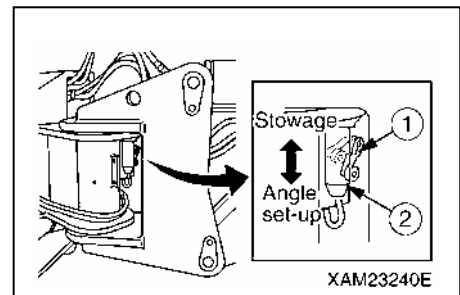

## [2] OUTRIGGER SETTING LAMPS

The lamp turns on to indicate that the outrigger is set.

Turns on when the outrigger tray (3) is set, and turns off when the tray (3) floats (stow).

The conditions of the outrigger tray (3) are detected by the detection pin (1) at the tip of the inner box (2) and by the detection switch inside the inner box.

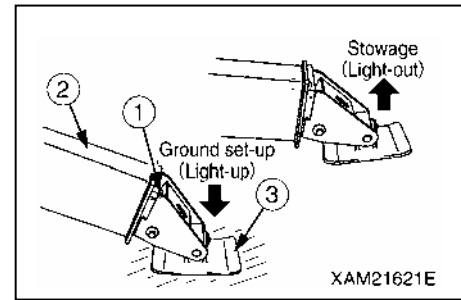

## [3] BOOM STOWING LAMP

This lamp turns on and indicates that the boom is stowed.

The boom stowing lamp turns on and off in accordance to the following two types of detection switches. (When both of the detection switches detect.)

### [BOOM STOWING DETECTION IN SLEWING DIRECTION]

The lamp turns on when the boom stops at the slew and stow position, and turns off when the boom leaves the slew and stop position.

Boom movements are detected by the projection (2) (slew) on the post and the detection switch (1) (fix) on the traveling dolly.

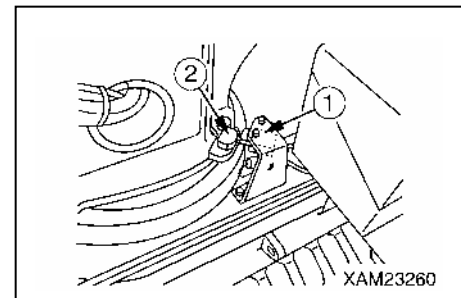

### [BOOM STOWING DETECTION IN HORIZONTAL DIRECTION]

The lamp turns on when the boom stops at the horizontal stowing position, and turns off when the boom leaves the horizontal stowing position.

Boom movements are detected by the projection (4) (movable) at the side of the boom rear edge and the detection switch (3) (fixed) at the boom connection.

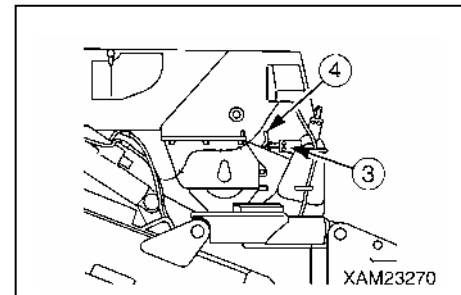

## 1.5.3 OUTRIGGER UN-SET WARNING LAMP (Yellow)

This lamp flashes to indicate that one or more of the four outriggers are not properly set.

### NOTES

- The outrigger un-set warning lamp flashes if extension or setting of any of the four outriggers cannot be detected.
- The outrigger un-set warning lamp is interlocked with the working status lamp (red) for moment limiter. As soon as the outrigger un-set warning lamp flashes, the working status lamp (red) also rotates and lights up.

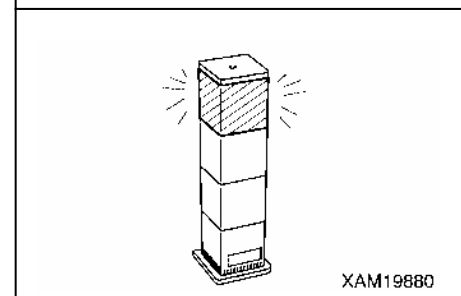
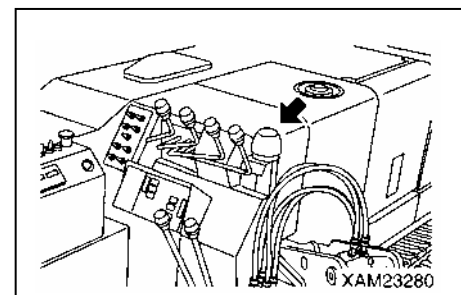

## 1.6 MOMENT LIMITER (OVERLOAD DETECTOR)

### 1.6.1 MOMENT LIMITER CONFIGURATION

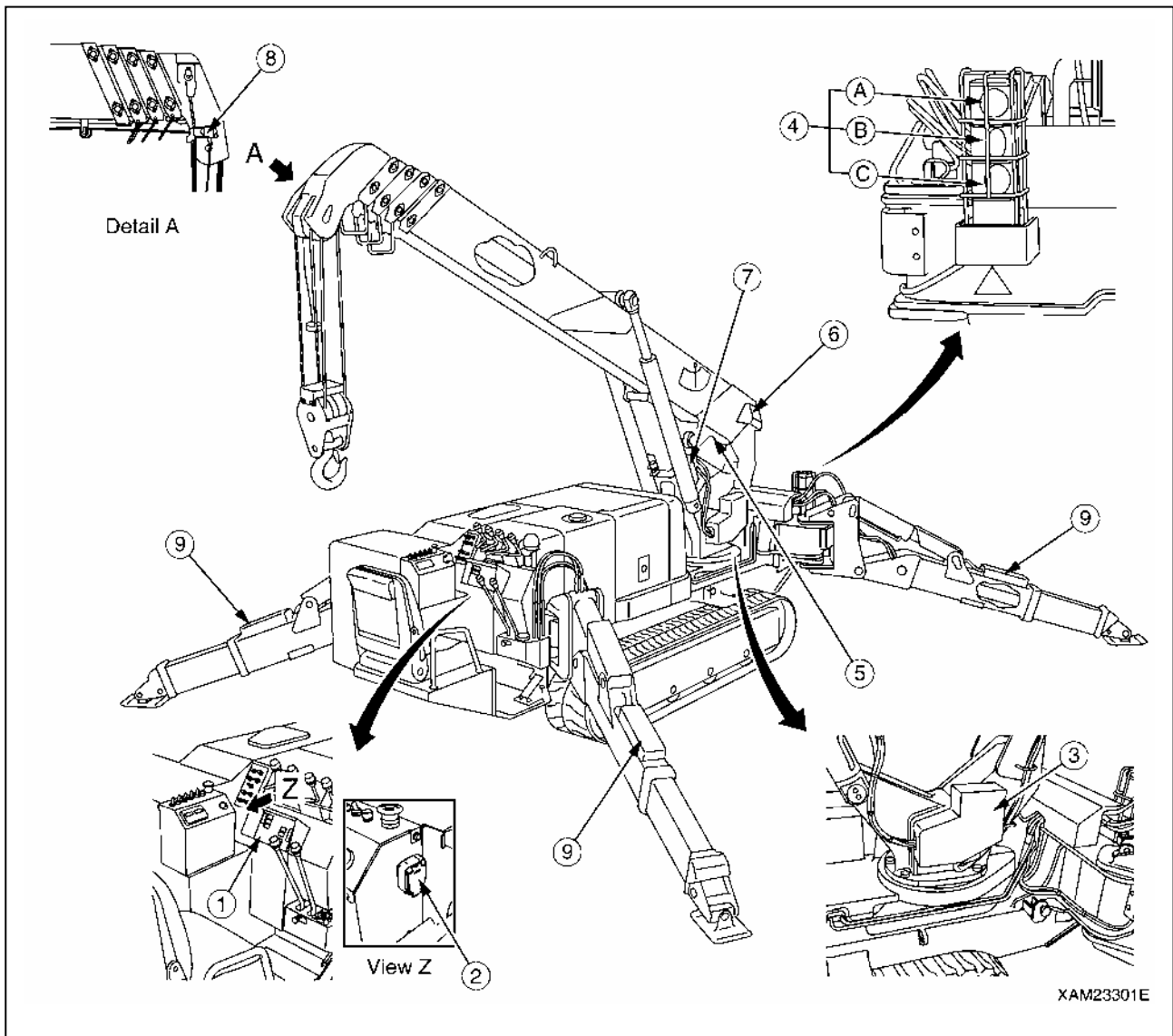

- |  |  |
|--|--|
| (1) Moment limiter display unit  | (5) Boom length gauge (inside boom)            |
| (2) Emergency stop cancel switch   | (6) Boom angle gauge (side of boom rear edge)  |
| (3) Moment limiter converter   | (7) Pressure sensor (derrick cylinder) (two)   |
| (4) Working status lamp  | (8) Overwind alarm detector (side of boom tip) |
| (A) Red working status lamp (Warning lamp for load factor of 100 % or more)      | (9) Outrigger position detection switch        |
| (B) Yellow working status lamp (Pre-warning lamp for load factor of 90 to 100 %) |  |
| (C) Green working status lamp (Working lamp for load factor of less than 90 %)   |  |

## 1.6.2 FUNCTION OF MOMENT LIMITER

### **⚠ DANGER**

- Do not remove, disassemble, or repair detectors. Do not move the detectors to another location from original position.
- Should an object hit a detector or you find any damage on a detector, be sure to verify the actuation status of the auto stop.

If you find any abnormality with the actuation of the auto stop, do not fail to fix it.

- Do not turn ON (cancel) the emergency stop cancel switch unless you find an error or check/perform maintenance on detectors.

When turning ON (cancel) the emergency stop cancel switch, always shift the crane speed to low.

Overloading can cause the hoisted load to fall, boom breakage, or overturning of this machine that can lead to serious accidents resulting in death or serious injury.

- The machine will not stop automatically even if the crane is overloaded during the crane slewing operation. Do not slew the crane when being overloaded.
- When the boom approaches the stop position during the operation, be sure to change the operation speed of the boom to low speed.

With high-speed boom operation, the boom may overrun the specified stop position, causing serious accidents such as overturning of the machine resulting in death or serious injury.

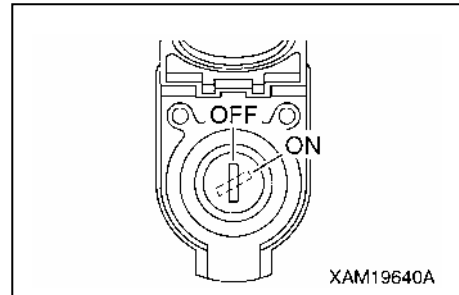

The moment limiter is a device installed to prevent the hoisted load from falling, the boom from breaking, or the machine from overturning due to overloading.

Always check the operation of the moment limiter before crane operation to verify no abnormality.

### **[1] MECHANISM OF MOMENT LIMITER**

The moment limiter calculates current "rated total load" by knowing the current boom posture by the boom angle gauge and the boom length gauge, by knowing the outrigger extension condition by the outrigger position switch, and by knowing the number of wire falls (entered by the driver).

Then by actually hoisting a load, the "read load" (hoist load) is sent from the pressure sensor of the derrick cylinder to the moment limiter.

The moment limiter comparatively calculates between the "rated total load" computed out of the current posture and the "real load" (hoisted load), and issues an alarm if the result indicates the real load/rated total load=90 to 100%.

If the calculation result indicates the real load/rated total load=above 100%, an alarm is issued and the causes the boom operation to automatically stop.

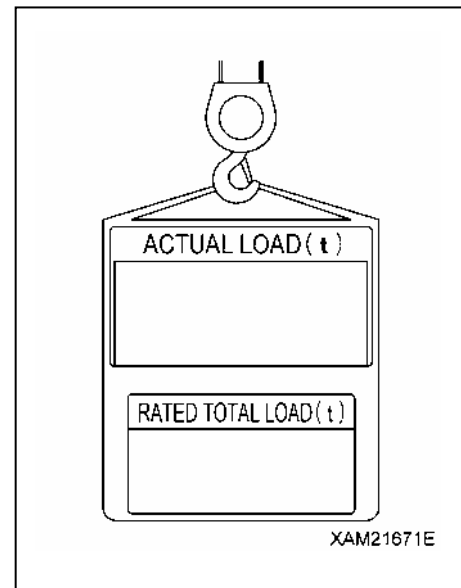

### **[2] DISPLAY OF THE MOMENT LIMITER ERROR MESSAGES**

The moment limiter performs self-diagnosis on the moment limiter display unit when an error is issued by the boom angle gauge, boom length gauge, pressure sensor, or when a circuit is opened or a connector is disconnected.

The result is displayed on the "Rated total load Display" of the moment limiter display unit by an error code to notify the operator of the error.

Immediately stop the use of the crane when an error code is displayed.

See "Operation 1.6.9 Moment Limiter Error Causes and Actions to be Taken".

### 1.6.3 MOMENT LIMITER OPERATIONS

The moment limiter is a device for unexpected events. Operations relying on the device will rather incur danger.

Pay sufficient attention during the operation not to cause auto-stop of the crane.

#### [1] PROHIBITED ACTIONS AFTER AUTO STOP

### DANGER

The following crane operations are prohibited after the crane has stopped automatically due to overloading. These operations may cause overturning of the machine or breakage of the boom and are very dangerous.

- Boom lowering operation
- Boom extending operation
- Hook raising operation
- Crane slewing operation

#### [2] RECOVERY OPERATION AFTER AUTO STOP

### DANGER

Be sure to switch the engine speed to low speed and perform crane operation carefully if the moment limiter load factor is 90 % or higher.

Performing crane operation at high engine speed will swing the hoisted load and is very dangerous, causing overloading and it may break the boom.

#### 1. With load factor of “less than 90 %”

When the hoisting load is less than 90 % of the rated total load, the working status lamp lights in green, indicating normal operation status.

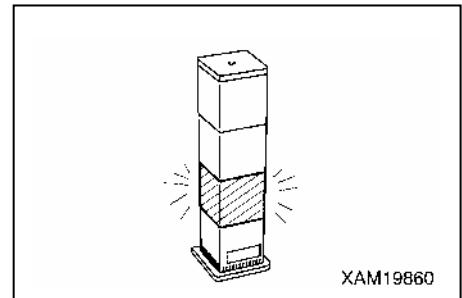

#### 2. With load factor of “90 to less than 100 %”

When the hoisting load reaches 90 % of the rated total load (pre-warning), the working status lamp changes from green to yellow and the alarm sounds intermittently, notifying the operator and those around that the hoisting load is close to the rated total load.

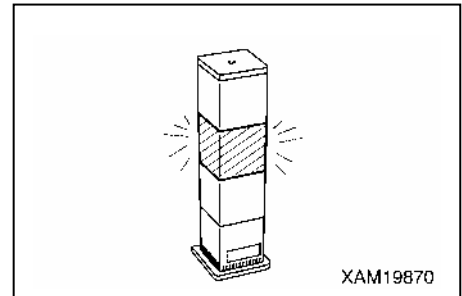

#### 3. With load factor of “100 % or higher”

When the hoisting load reaches 100 % of the rated total load by continuing the crane operation after exceeding 90 % of the rated total load (pre-warning), the working status lamp changes from yellow to red and the alarm now sounds continuously. The following crane operations will stop automatically.

- Hook raising operation
- Boom extending operation
- Boom lowering operation

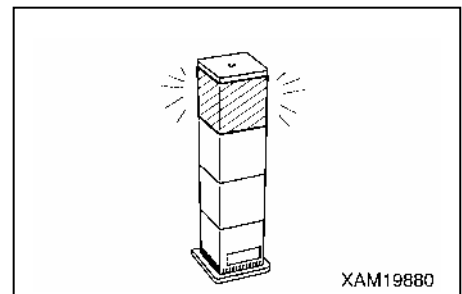

The audible message of “Peep, overloading” will be issued. Furthermore, the LED of “100 %” on the moment limiter load factor display lights up.

#### 4. Recovery Operation from Auto Stop

The recovery operation from overloading should be the reverse operation of the crane operation that caused the auto stop. Perform one of the followings.

(1) Lower the hook and put down the hoisted load on the ground.

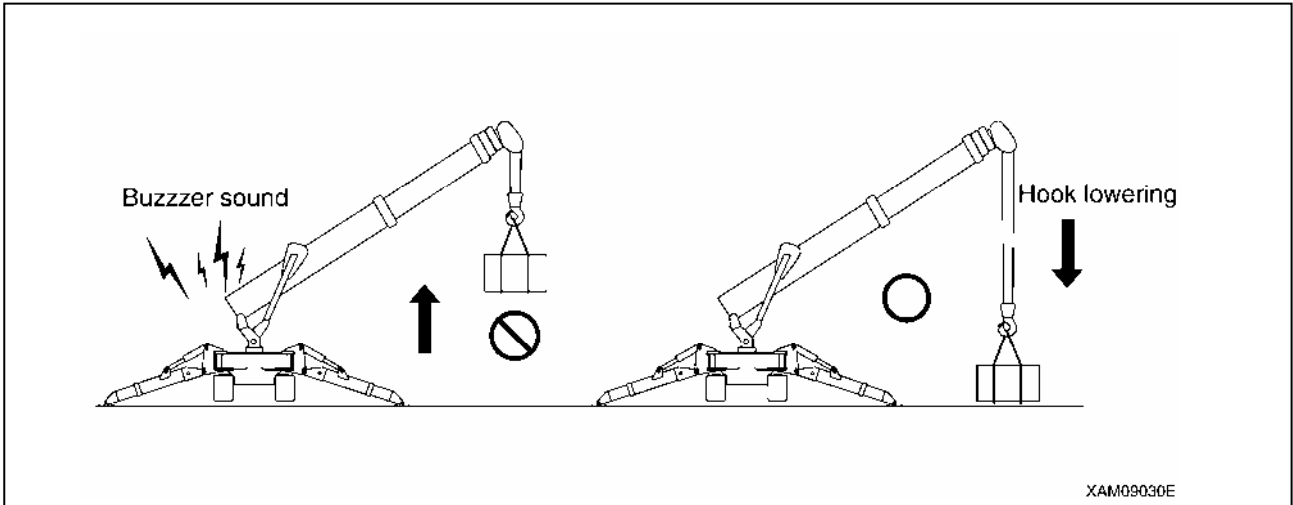

(2) Raise the boom. Lower the hook so that the hoisted load will be as low as possible.

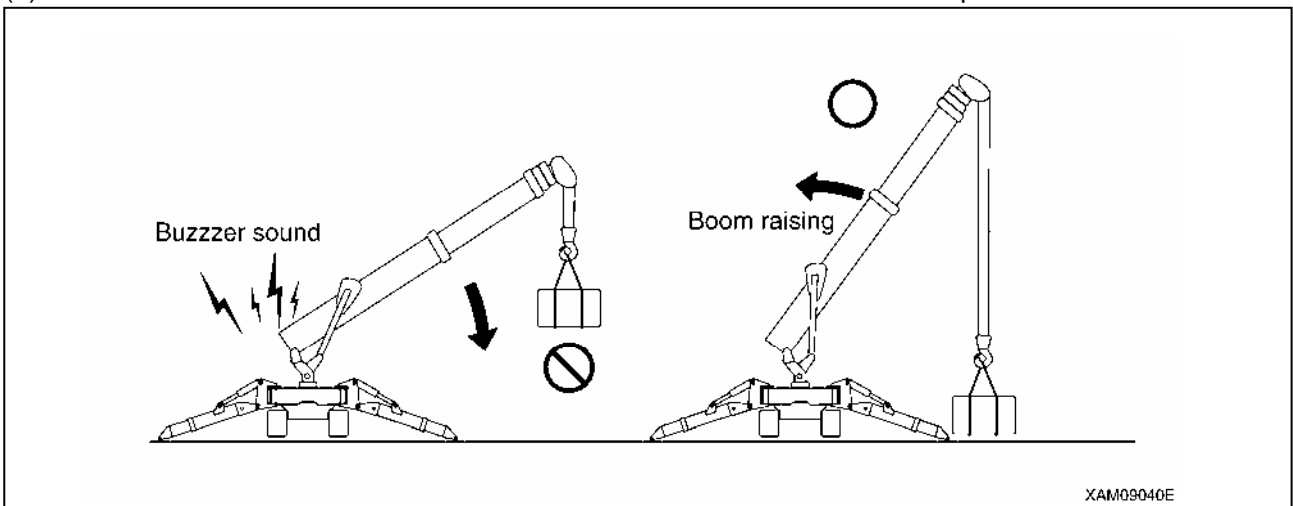

(3) Retract the boom.

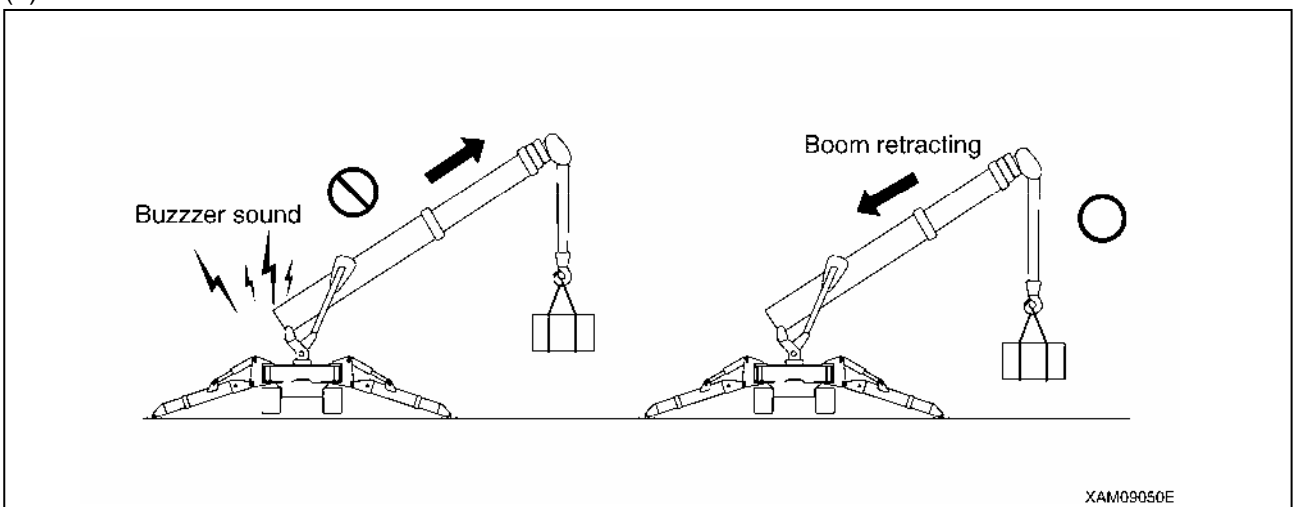

## 1.6.4 NAMES OF MOMENT LIMITER DISPLAY UNIT

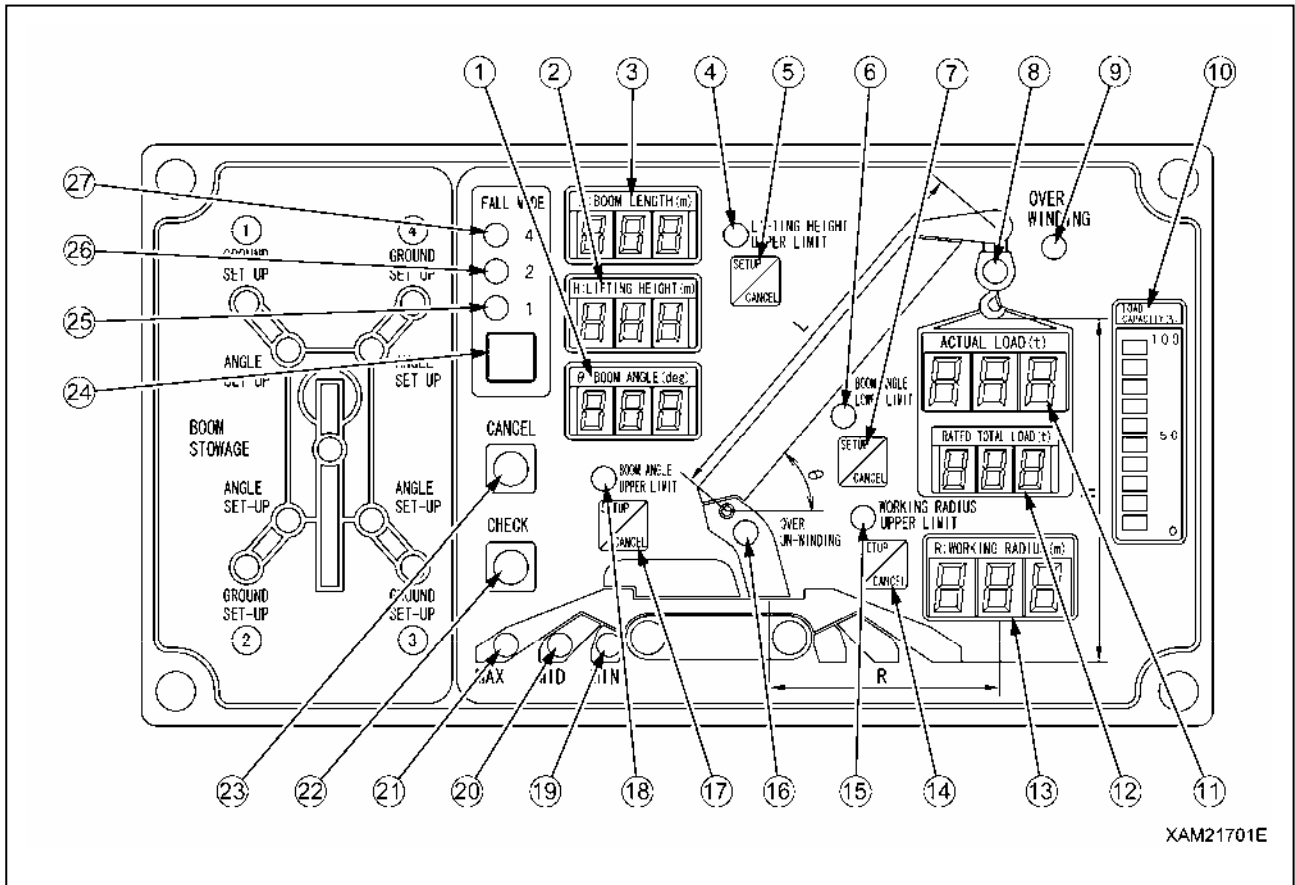

XAM21701E

- |   |  |
|---|--|
| (1) Boom angle display                                  | (14) Working radius upper limit switch       |
| (2) Lifting height display                              | (15) Working radius upper limit LED (Orange) |
| (3) Boom length display                                 | (16) Over un-winding LED (Orange)            |
| (4) Boom lifting height upper limit LED (Orange)        | (17) Boom angle upper limit switch           |
| (5) Boom lifting height upper limit switch              | (18) Boom angle upper limit LED (Orange)     |
| (6) Boom angle lower limit LED (Orange)                 | (19) Outrigger MIN. extension LED (Blue)     |
| (7) Boom angle lower limit switch                       | (20) Outrigger MID. extension LED (Blue)     |
| (8) Load factor LED (Changes to green, yellow, and red) | (21) Outrigger MAX. extension LED (Blue)     |
| (9) Over hoist detection LED (Red)                      | (22) Check switch                            |
| (10) Load capacity display (Yellow)                     | (23) Cancel switch                           |
| (11) Actual load display                                | (24) Fall mode selector switch               |
| (12) Rated total load display                           | (25) 1-fall fall LED (Blue)                  |
| (13) Working radius display                             | (26) 2-falls fall LED (Blue)                 |
|   | (27) 4-falls fall LED (Blue)                 |

## [1] DESCRIPTIONS OF SWITCHES ON MOMENT LIMITER DISPLAY UNIT

### 1. WIRE FALLS SELECTOR SWITCH AND WIRE FALLS DISPLAY LED (BLUE)

#### **⚠ DANGER**

When entering the number of wire falls, verify the actually used number of wire falls and make sure to set up correctly.

Entering incorrect number of wire falls may prevent issuance of the pre-warnings and boom auto-stop even when the overload is near happening, and thus may result in crane damage or machine trip that may result in serious accidents.

Use this switch to change the number of wire falls.

- Keep pressing the switch for 2 seconds or more.

The setting changes from “4-falls” to “1-fall”.

At the same time, the wire falls display LED changes from “4-falls” to “1-fall”, indicating that the setting has changed.

- Then each time you press the switch for 2 seconds or more, the setting of the wire falls changes from “1-fall” to “2-falls”, and then from “2-falls” to “4-falls”.

#### **NOTES**

When changing the setting right after doing so, release your hand from the switch, and then press the switch again.

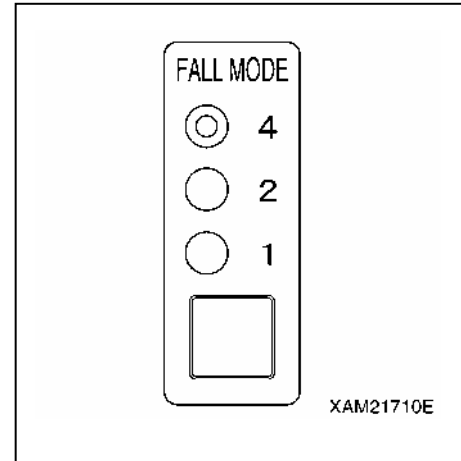

### 2. BOOM ANGLE UPPER LIMIT SWITCH AND LED (ORANGE)

Use this switch to set or cancel the boom angle upper limit.

#### **[SETUP]**

With no upper limit value being set, set the boom to the angle you would like, and press the switch for 2 seconds.

The boom angle at this point is set as the upper limit.

At the same time, the LED lights up indicating that the upper limit value was set.

To enable this setting, turn the key switch to the “ON” position again after turning it to the “OFF” position, or lower the boom by “10 degrees” or more from the set boom angle to get out of the pre-warning zone while the engine is being started.

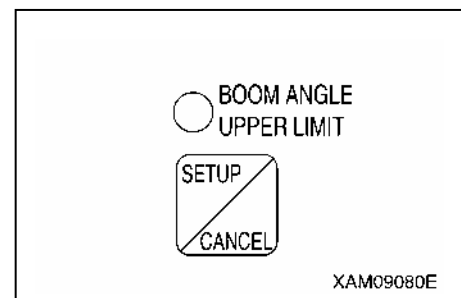

#### **NOTES**

Be sure to verify that the boom automatically stops at the set angle before performing the actual operation. If the boom does not stop automatically, re-set the boom angle using the procedure above.

When the boom reaches the pre-warning zone or stops at the upper limit with the boom angle upper limit set, the boom angle upper limit LED flashes.

#### **[CANCEL]**

With the upper limit value being set (LED ON), press the switch for 5 seconds.

The current upper limit value setting will be cleared. At the same time, the LED goes off indicating that the upper limit value setting is cleared.

#### **NOTES**

The setting and canceling will not repeat even if you keep the switch pressed for more than 2 seconds. Let your hand go off the switch and press the switch again.



### 3. BOOM ANGLE LOWER LIMIT SWITCH AND LED (ORANGE)

Use this switch to set or cancel the boom angle lower limit.

#### [SETUP]

With no lower limit value being set, set the boom to the angle you would like, and press the switch for 2 seconds.

The boom angle at this point is set as the lower limit.

At the same time, the LED lights up indicating that the lower limit value was set.

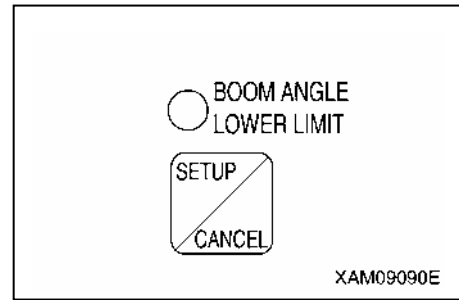

To enable this setting, turn the key switch to the "ON" position again after turning it to the "OFF" position, or raise the boom by "7 degrees" or more from the set boom angle to get out of the pre-warning zone while the engine is being started.

#### NOTES

Be sure to verify that the boom automatically stops at the set angle before performing the actual operation. If the boom does not stop automatically, re-set the boom angle using the procedure above.

When the boom reaches the pre-warning zone or stops at the lower limit with the boom angle lower limit set, the boom angle lower limit LED flashes.

#### [CANCEL]

With the lower limit value being set (LED ON), press the switch for 5 seconds.

The current lower limit value setting will be cleared. At the same time, the LED goes off indicating that the lower limit value setting is cleared.

#### NOTES

The setting and canceling will not repeat even if you keep the switch pressed for more than 2 seconds. Let your hand go off the switch and press the switch again.

### 4. WORKING RADIUS UPPER LIMIT SWITCH AND LED (ORANGE)

Use this switch to set or cancel the working radius upper limit.

#### [SETUP]

With no upper limit value being set, set the boom to the working radius you would like, and press the switch for 2 seconds.

The working radius at this point is set as the upper limit.

At the same time, the LED lights up indicating that the upper limit value was set.

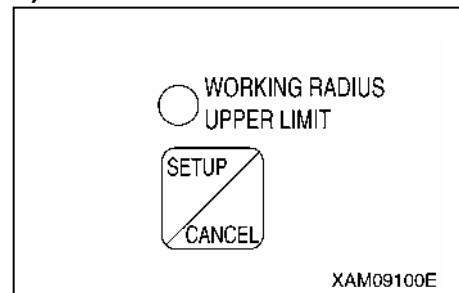

To enable this setting, turn the key switch to the "ON" position again after turning it to the "OFF" position, or reduce the working radius by "1.3 m" or more from the set working radius to get out of the pre-warning zone while the engine is being started.

#### NOTES

Be sure to verify that the boom automatically stops at the set working radius before performing the actual operation. If the boom does not stop automatically, re-set the working radius using the procedure above.

When the boom reaches the pre-warning zone or stops at the upper limit with the working radius upper limit set, the working radius upper limit LED flashes.

#### [CANCEL]

With the upper limit value being set (LED ON), press the switch for 5 seconds.

The current upper limit value setting will be cleared. At the same time, the LED goes off indicating that the upper limit value setting is cleared.

#### NOTES

The setting and canceling will not repeat even if you keep the switch pressed for more than 2 seconds. Let your hand go off the switch and press the switch again.

## 5. LIFTING HEIGHT UPPER LIMIT SWITCH AND LED (ORANGE)

Use this switch to set or cancel the lifting height upper limit.

While the lifting height is restricted by detecting the height of the tip of the boom, the lifting height on the display panel shows the lifting height when the hook was raised to the over hoist detection status.

### [SETUP]

With no upper limit value being set, set the boom to the lifting height you would like, and press the switch for 2 seconds.

The lifting height at this point is set as the upper limit.

At the same time, the LED lights up indicating that the upper limit value was set.

To enable this setting, turn the key switch to the "ON" position again after turning it to the "OFF" position, or reduce the lifting height by "1.3 m" or more from the set lifting height to get out of the pre-warning zone while the engine is being started.

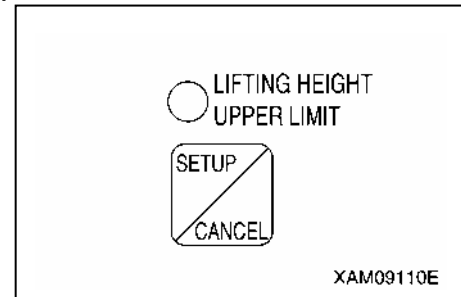

### NOTES

Be sure to verify that the boom automatically stops at the set lifting height before performing the actual operation. If the boom does not stop automatically, re-set the lifting height using the procedure above.

When the boom reaches the pre-warning zone or stops at the upper limit with the lifting height upper limit set, the lifting height upper limit LED flashes.

### [CANCEL]

With the upper limit value being set (LED ON), press the switch for 5 seconds.

The current upper limit value setting will be cleared. At the same time, the LED goes off indicating that the upper limit value setting is cleared.

### NOTES

The setting and canceling will not repeat even if you keep the switch pressed for more than 2 seconds. Let your hand go off the switch and press the switch again.

## 6. CANCEL SWITCH

Use this switch to cancel the all setting sets in the section 2 to 5 above.

- Press this switch and "CHECK" switch at the same time for 5 seconds or more.

The all value sets in the section 2 to 5 above will be canceled.

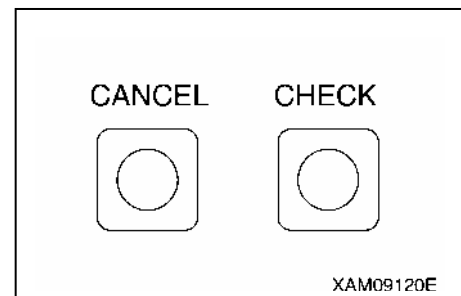

## 7. CHECK SWITCH

Use this switch to verify the values set in the section 2 to 5 above.

- Press this switch. Every time the switch is pressed, the set value will be displayed in the following order.

- (1) "Boom angle upper limit value" is displayed at the boom angle display section.
- (2) "Boom angle lower limit value" is displayed at the boom angle display section.
- (3) "Working radius upper limit value" is displayed at the working radius display section.
- (4) "Lifting height upper limit value" is displayed at the lifting height display section.
- (5) Returns to the original display.

### NOTES

- When a set value is displayed, the LED for its setting switch section flashes at the same time.
- If no switch was pressed for 5 seconds or another switch was pressed with a set value being displayed, the display goes back to the original display.
- The display will be a blank for the item to which no value is set.
- The display sections other than for the corresponding items will be blank.

CHECK

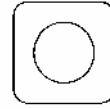

XAM22160E

L: BOOM LENGTH (m)



H: LIFTING HEIGHT (m)



$\theta$ : BOOM ANGLE (deg)



XAM09140E

R: WORKING RADIUS (m)

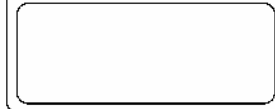

XAM09150E

## [2] DESCRIPTIONS OF MOMENT LIMITER DISPLAY UNIT

For LEDs not described in this section, see "Operation 1.6.4 Names of moment limiter display unit".

### 1. ACTUAL LOAD DISPLAY SECTION

This section constantly displays the actual load of the hoisted load during the crane operation.

The actual load indicates the total weight of the hoisted load including rigging and the hook block.

If "0.0" to "0.1" is displayed when nothing is being hoisted, the system is normal.

If the value displayed is out of this range, contact us or our sales service agency.

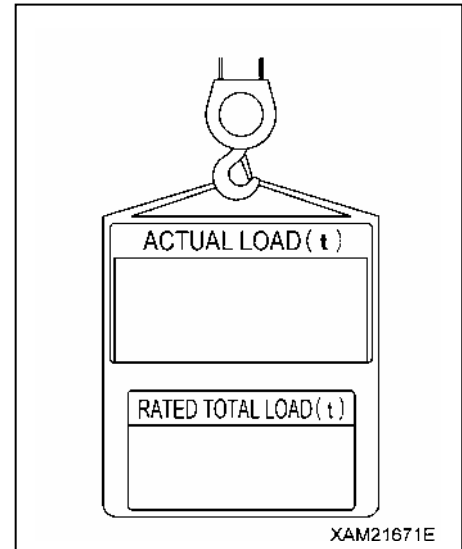

### 2. RATED TOTAL LOAD DISPLAY SECTION

This section displays the number of wire falls on the hook, working radius, currently hoistable rated total load (hook weight + rigging weight + load to be hoisted) computed out of the conditions such as the degree of outrigger extension.

### 3. WORKING RADIUS DISPLAY SECTION

This section constantly displays the current working radius during the crane operation.

The working radius is the horizontal distance from the crane slewing center to the center of the hook.

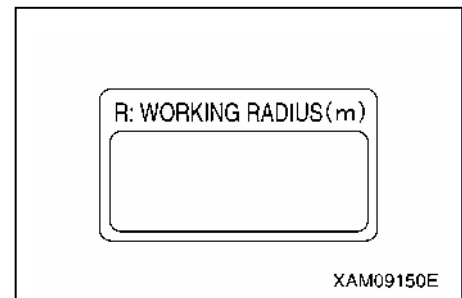

### 4. BOOM LENGTH DISPLAY SECTION

This section constantly displays the current boom length during the crane operation.

The boom length is the distance from the boom foot pin to the sheave pin at the end of the boom.

### 5. LIFTING HEIGHT DISPLAY SECTION

This section constantly displays the current lifting height during the crane operation.

The lifting height is the vertical distance from the ground to the bottom of the hook.

### 6. BOOM ANGLE DISPLAY SECTION

This section constantly displays the current boom angle during the crane operation.

The boom angle is the angle the boom and the horizontal line form.

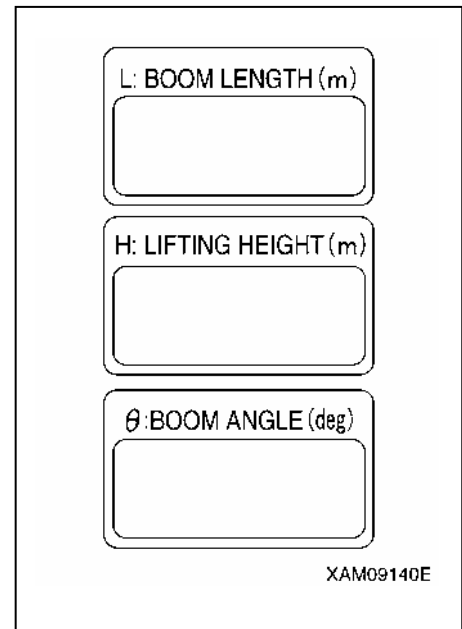

### 7. OVER WINDING LED (RED)

This LED flashes up when the hook is overwound, and issues overwinding warning and causes an automatic stop.

This LED also flashes when the hook is stowed during the hook stowing operation. This is normal.

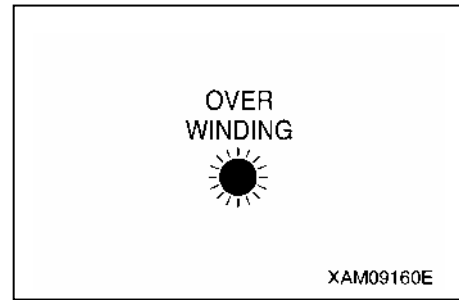

### 8. OUTRIGGER EXTENSION LED (BLUE)

The LED lights up to indicate the outrigger extension status.

- If any of the four outriggers has not properly reached the middle extension position, the "MIN" LED lights up.
- If all the four outriggers properly reach the middle extension position, the "MID" LED lights up.
- If all the four outriggers reach the maximum extension position, the "MAX" LED lights up.

Even if you thought you had set the outriggers at the maximum extension position, the "MID" LED lights up if any of the outriggers did not properly reach the maximum extension position.

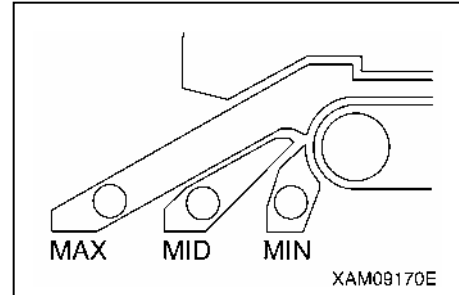

### 9. LOAD FACTOR LED (CHANGES TO GREEN/YELLOW/RED)

This LED indicates the status of the moment limiter load factor by its illumination.

- The LED lights up in green if the load factor is less than 90 %.
- The LED lights up in yellow if the load factor is 90 to less than 100 %.
- The LED lights up in red if the load factor is 100 % or higher.

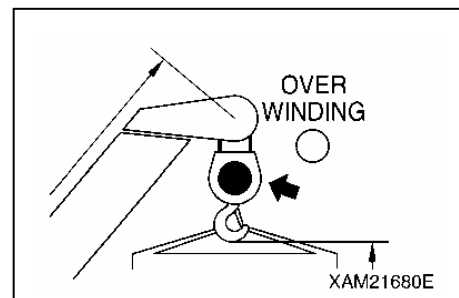

### 10. LOAD FACTOR DISPLAY (YELLOW)

This display indicates the status of the moment limiter load factor by its illumination.

- The load factor is indicated by ON/OFF of the "bar" according to the changes of the load factor.
- All the "bars" will be ON when the load factor reaches 100 % or higher.

| NOTES  |  |
|--|--|
| When the load factor is about 50 %, all the "bars" around the number "50" on the right and below are ON. |  |
| All the "bars" around the number "50" and above are OFF.   |  |

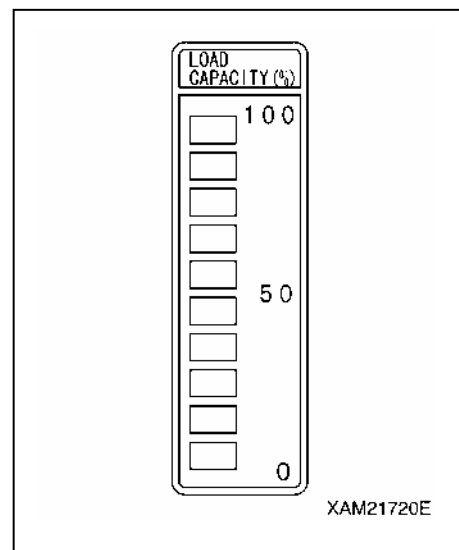

## 1.6.5 MOMENT LIMITER FUNCTIONS

### [1] OVERLOAD WARNING

**1. SAFETY ZONE** (“Actual load” is less than 90 % of the “rated total load”)

- Green of the working status lamp lights up.
- The LED lights up in green if the load factor is less than 90 %.

**2. PRE-WARNING** (“Actual load” is 90 to less than 100 % of the “rated total load”)

- Yellow of the working status lamp lights up.
- The LED lights up in yellow if the load factor is 90 to less than 100 %.
- The alarm bleeps intermittently.

**3. LIMIT WARNING** (“Actual load” is 100 % or higher than the “rated total load”)

- Red of the working status lamp lights up.
- The LED lights up in red if the load factor is 100 % or higher.
- The alarm bleeps continuously.
- The hazardous operation of the boom stops automatically.
- Voice message of “Overloading” is heard.
- “Load factor 100 % or more” LED (yellow) lights up.

#### 4. CLEARING LIMIT WARNING AUTO STOP

If the system stops automatically, promptly perform the recovery operation caused by overloading. See “Operation 1.6.3 [2] Recovery Operation After Auto Stop” for recovery operations.

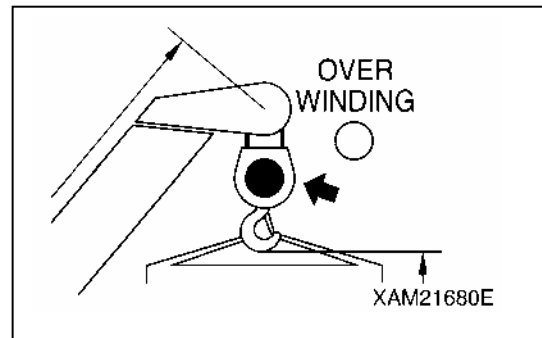
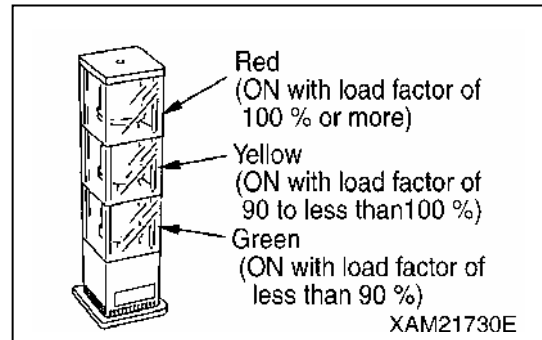

## [2] WORKING ENVELOPE RESTRICTION WARNING

When the working envelope gets close to the set restriction value, a warning is issued to notify the operator and people around of the situation.

The last status of the set value for the working envelope restriction is memorized even if the starter switch is turned to the OFF position.

### NOTES

See "Operation 1.6.4 [1] Descriptions of Switches on Moment Limiter Display Unit" for how to set the value for working envelope restriction.

When the working envelope has been set, the restriction will be as follows.

#### 1. SAFETY ZONE

- The appropriate working envelope restriction LED (orange) lights up.
- Green of the working status lamp lights up.

#### 2. PRE-WARNING

- The appropriate working envelope restriction LED (orange) lights up.
- The alarm bleeps intermittently.

#### 3. LIMIT WARNING

- The appropriate working envelope restriction LED (orange) lights up.
- Red of the working status lamp lights up.
- The alarm bleeps continuously.
- The hazardous operation of the boom stops automatically.

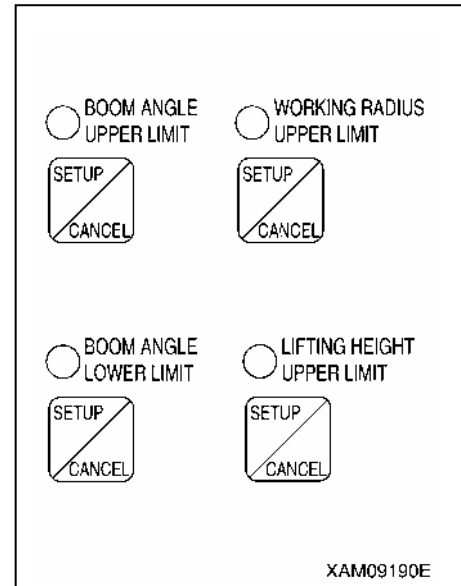

## [3] OVER HOIST DETECTOR

### CAUTION

**Pay attention to the distance between the hook and boom when raising the hook.  
Extending the boom also raises the hook.  
Always check the hook height when extending the boom.**

When you overwind the hook when raising the hook or extending the boom,

- The "Overwinding" LED (red) flashes.
- The alarm bleeps continuously.
- The hook raising and boom extending operation stop automatically.
- The voice saying "hook is overwinded" is heard.

In case of auto stop, immediately perform the recovery operation. Perform hook lowering and boom retracting operations as recovery operations.

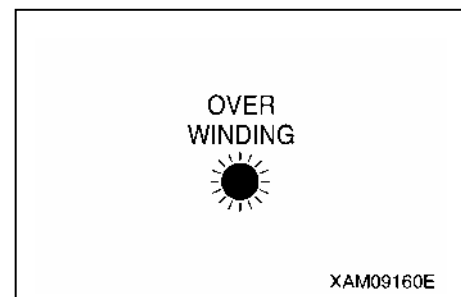

#### [4] NUMBER OF WIRES SELECTOR SWITCH

### ⚠ WARNING

- Stop the crane operation when changing the number of wires hooked using the number of wires selector switch.  
Changing the number of wires during the crane operation can cause unexpected accidents.
- Perform the crane operation always after matching the number of wires display on the moment limiter and the actual number of wires. Mistaking the number of wires cause serious accidents.

The wire rope has the safe load per rope determined.

Determine the number of wires according to the maximum load to be hoisted.

The actual number of wires hooked and the number of wires display on the moment limiter must match.

With this machine, the hook for four/two wire ropes is referred to as the standard specifications.

The last status of the set number of wires is memorized even if the starter switch is turned to the OFF position.

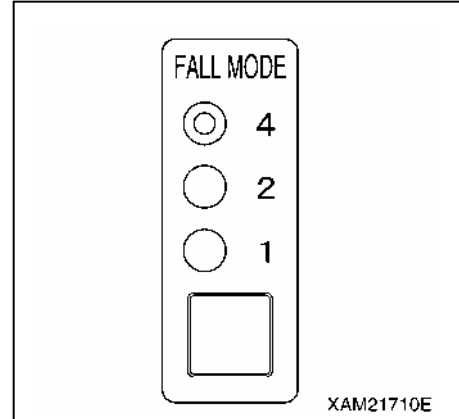

#### [5] BOOM UPPER LIMIT DETECTION

When the boom is raised and the boom angle reaches “about 77 degrees”, the boom raising operation stops automatically.

#### [6] BOOM LOWER LIMIT DETECTION

When the boom is lowered and the boom angle reaches “about 3 degrees”, the boom lowering operation stops automatically.

#### [7] OUTRIGGER EXTENSION DETECTION

The outrigger extension status is detected with the limit switch mounted to each of four outriggers, lighting the appropriate LED (blue) of the “MIN”, “MID”, or “MAX” and changing the rated total load.

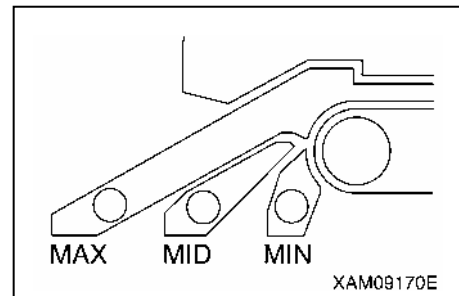

### 1.6.6 MOMENT LIMITER STARTING STATUS

The moment limiter checks its function for 2 seconds when the starter switch is turned to the ON position. Meanwhile,

- The red of the working status lamp lights up.
- All the LEDs light up.
- The horn sounds momentarily.

Then, if the moment limiter and the sensors are normal upon the completion of the functional check of the moment limiter, the red of the working status lamp goes off and green of the working status lamp lights up indicating that the machine is ready for use.

### CAUTION

If the red of the working status lamp does not go off after completing the functional check of the moment limiter, be sure to contact us or our sales service agency.



## 1.6.7 MOMENT LIMITER WORKING ENVELOPE SETTING

### **⚠ WARNING**

- The boom may go beyond the set value when operated at high speed even if the working envelope was restricted by the moment limiter.  
Be sure to set the working envelope with safe distance from obstacles.  
Operate the crane at low speed.
- Be sure to verify that the boom stops at the set position after setting the boom working envelope.

If the boom working envelope is limited due to working space issue, you can set the boom working envelope to the desired value.

#### **[1] SETTING WORKING ENVELOPE**

Operate the boom to the limit of the working envelope you would like to restrict, and press the appropriate SETUP/CANCEL switch for 2 seconds.

You can set that limit value.

At the same time, the LED above the appropriate switch lights up. Then, return the boom to the following setting to enable the restriction control.

“Set value – 10 degrees or more” for boom upper limit.

“Set value + 7 degrees or more” for boom lower limit.

“Set value – 1.3 m or less” for working radius upper limit

“Set value – 1.3 m or less” for lifting height (With [Lower] or [Retract] operation of the boom)

Or, turn the starter switch to the “OFF” position and then turn again to the “ON” position to enable the restriction.

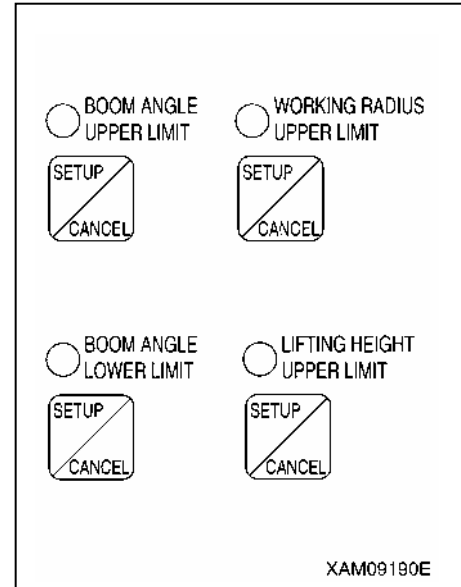

#### **NOTES**

The last status of the set value has been held in memory even if the starter switch is turned to the “OFF” position.

#### **[2] CANCELING WORKING ENVELOPE SETTING**

- Press and hold the CANCEL switch and CHECK switch at the same time for 5 seconds or more.

All the set working envelope restrictions are canceled.

At the same time, the LED above all the working envelope limit switches go off to complete the cancellation of the settings.

- Press the SETUP/CANCEL switch of the item which restriction you would like to cancel for 5 seconds.

The set value of only the item can be canceled.

At the same time, the LED above the switch goes off to complete the cancellation of the setting.

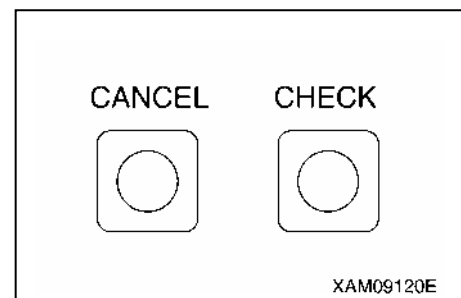

#### **NOTES**

See “Operation 1.6.4 [1] Descriptions of Switches on Moment Limiter Display Unit” for how to set limit on the working envelope.

## 1.6.8 EMERGENCY STOP CANCEL SWITCH

### **⚠ DANGER**

Do not turn ON (cancel) the emergency stop cancel switch unless you find an error or check/perform maintenance on detectors.

When turning ON (cancel) the emergency stop cancel switch, always shift the crane speed to low. Keep the switch key removed during normal crane operation.

### **CAUTION**

Do not use the emergency stop cancel switch when stowing the hook. The winch wire rope may be cut, causing the hook to fall or boom to be damaged. Use the hook stowing switch for stowing the hook.

Use the emergency stop cancel switch when inspecting, performing maintenance, and canceling the operation stop as needed.

Open the cover when using the switch.



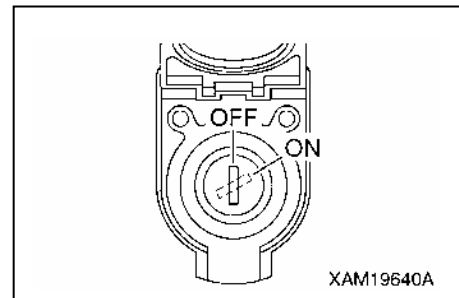





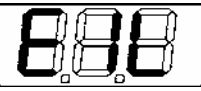

- OFF (Auto): Turn the key counterclockwise.  
The operation stop functions.  
The key can be removed or inserted at this position.
- ON (Cancel): Turn the key clockwise and hold it at that position.  
The operation stop function is canceled while the key is held.



### 1.6.9 MOMENT LIMITER ERROR CAUSES AND ACTIONS TO BE TAKEN

The moment limiter displays an error code at the “rated total load” display section on the display panel to notify the error.

If an error code shown in the table below was displayed, contact us or our sales service agency.

| Error Code   | Error Details   | Actions to Be Taken   |
|--|---|---|
| E1L<br>   | The input to pressure sensor 1 is lower than the specified value.                                 | Check the installation of the pressure sensor 1.  |
| E1H<br>   | The input to pressure sensor 1 is higher than the specified value.                                |   |
| E2L<br>   | The input to pressure sensor 2 is lower than the specified value.                                 | Check the installation of the pressure sensor 2.  |
| E2H<br>   | The input to pressure sensor 2 is higher than the specified value.                                |   |
| E3L<br>   | The input to angle detector is lower than the specified value.                                    | Check the installation of the angle detector.   |
| E3H<br> | The input to angle detector is higher than the specified value.                                   |   |
| E4L<br> | The input to length detector is lower than the specified value.                                   | Check the installation of the length detector.  |
| E4H<br> | The input to length detector is higher than the specified value.                                  |   |
| EAD<br> | The AD converter at the converter section is not functioning properly.                            | Turn the starter switch to the “OFF” position and then to the “ON” position again. If an error is displayed again, change the converter.  |
| ERS<br> | The communication between the converter section and the display unit is not carried out properly. | <ul style="list-style-type: none"> <li>• Check the cable between the display unit and the converter. If the cable is normal, change the converter.</li> <li>• Check the fuse built-in the converter.</li> </ul> |
| E-E<br> | Error with calibration memory. This error is also issued when calibration has not been done yet.  | Turn the starter switch to the “OFF” position and then to the “ON” position again. If an error is displayed again, change the display unit.   |
| No displayed   | ---   | Check the fuse built-in the display unit.   |

## 1.7 OVER HOIST DETECTOR

### CAUTION

Pay attention to the distance between the hook block and the boom when raising the hook block.

The hook block also raises when the boom is extended.

Always check the height of the hook block when performing the boom extending operation.

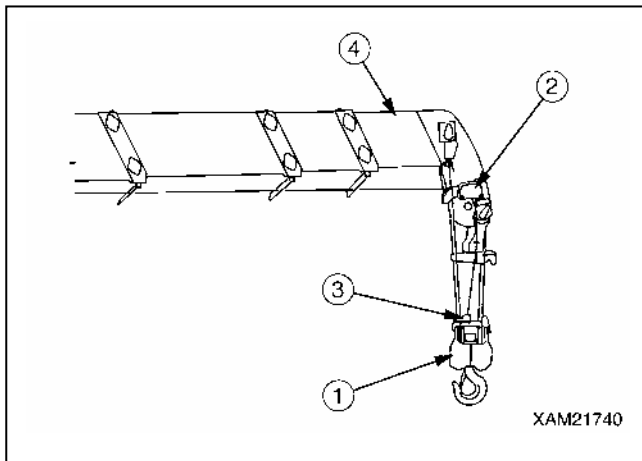

- (1) Hook block
- (2) Over hoist detector
- (3) Weight
- (4) Boom

When the hook block (1) was raised or the boom (4) was extended, the over hoist detector intermittently activates the buzzer to warn the operator of overwinding if the hook block (1) approached the end of the boom (4) and pushed up the weight (3).

At the same time, the raising of the hook block (1) and the extension of the boom (4) stop automatically. When a warning buzzer sounds, operate the winch lever immediately to the "LOWER" side or operate the boom telescoping lever to the "RETRACT" side to lower the hook block (1).

## 1.8 OPERATION SEAT

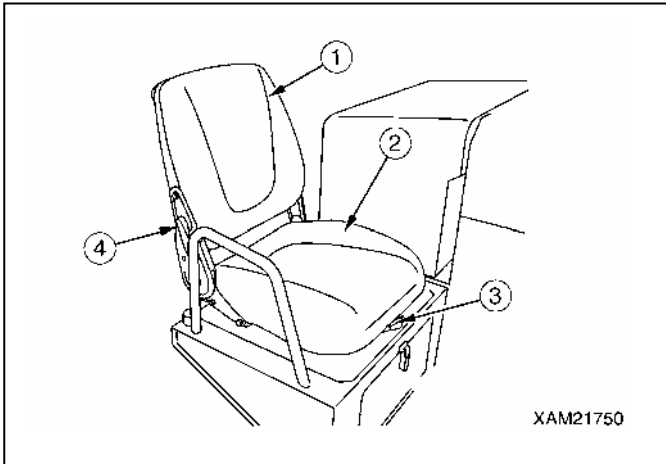

- (1) Back seat
- (2) Seat
- (3) Slide adjusting lever
- (4) Reclining adjusting lever

### **⚠ WARNING**

- **Adjust the operation seat before driving. Be sure to make adjustment especially after someone else has used it.**
- **Press your back against the back seat of the operation seat and adjust the operation seat so that you can operate the acceleration pedal, control levers and traveling lever without any difficulty.**
- **Never adjust the operation seat while driving the machine.**

### **[1] SEAT FORWARD/BACKWARD SLIDE ADJUSTMENT**

Use the slide adjusting lever (3) to make adjustment.

1. While pushing the slide adjusting lever (3) leftward, move the seat (2) forward/backward.
2. After adjusting the seat (2), release your hand from the slide adjusting lever (3).  
The seat (2) is fixed to the position.

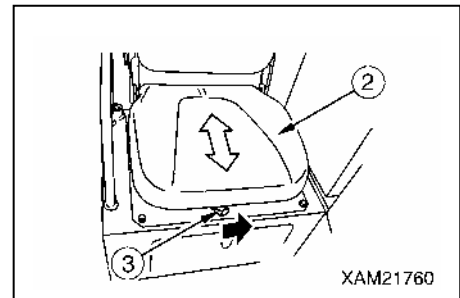

### **NOTES**

The forward/backward slide adjustment distance is 120 mm in 6 steps.

### **[2] RECLINING ADJUSTMENT**

Use the reclining adjusting lever (4) to make adjustment.

1. While pushing the reclining adjusting lever (4) forward, move the backseat (1) forward/backward.
2. After adjusting the back seat (1), release your hand from the reclining adjusting lever (4).  
The back seat (1) is fixed to the position.

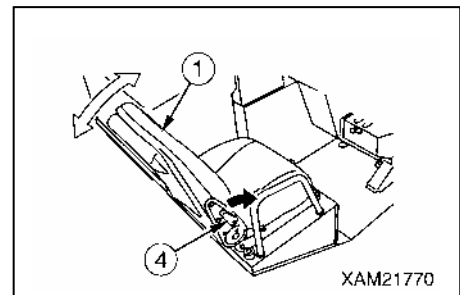

### **NOTES**

The reclining adjustment angle is 75 degrees in 7 steps forward and 23 steps in backward.

## 1.9 ENGINE HOOD

### **⚠ WARNING**

- Be sure to stop the engine and remove the starter switch key before opening the engine hood.
- Do not open the engine hood immediately after the operation while the engine is still hot.

#### **[1] OPENING ENGINE HOOD**

Open the engine hood with the following procedure when performing inspection/maintenance inside the engine hood.

1. See "Operation 2.2 Starting Engine" and start the engine.
2. See "Operation 2.14 Outrigger Setting Operation" and set the outriggers.
3. See "Operation 2.19 Boom Derricking Operation" and raise the boom to the angle at which you can work without difficulty.
4. See "Operation 2.10 Stopping Engine" and stop the engine.
5. See "Operation 2.14 Outrigger Setting Operation" and rotate the rotary of the "outrigger (3)" and "outrigger (4)" outward.
6. Insert the key into the keyhole of the knob (2) of the engine hood (1) and unlock the hood.
7. Open the engine hood (1) by pulling the knob (2) toward you. Slide the stay (3) and set it securely at the lock position (A).

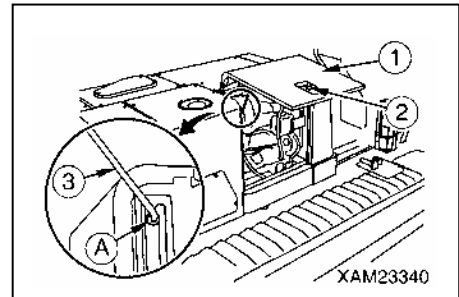

#### **[2] CLOSING ENGINE HOOD**

When you finished inspection/maintenance in the engine hood, close the engine hood using the following procedure.

1. Lift the stay (3) of the engine hood (1) and pull it out of the lock position (A). Close the engine hood.
2. Lock the knob (2) of the engine hood (1) and remove the key.
3. See "Operation 2.24 Outrigger Stowing Operation" to rotate the rotary of the "outrigger (3)" and "outrigger (4)" inward and stow.
4. See "Operation 2.2 Starting Engine" and start the engine.
5. See "Operation 2.23 Crane Stowing Operation" and stow the boom.
6. Operate the emergency stop cancel switch to the "OFF" (auto) position and remove the key.
7. See "Operation 2.10 Stopping Engine" and stop the engine and remove the starter key.

## 1.10 MACHINERY COVER

### ⚠ WARNING

- Be sure to stop the engine and remove the starter switch key before removing the machinery cover.
- Do not remove the machinery cover immediately after the operation while the engine is still hot.

### ⚠ CAUTION

The machinery cover is large and installed at high position. Be sure to remove/install the cover with two persons or more.

### [1] REMOVING MACHINERY COVER

Remove the machinery cover with the following procedure when performing inspection/maintenance inside the machinery cover.

1. See "Operation 2.2 Starting Engine" and start the engine.
2. See "Operation 2.14 Outrigger Setting Operation" and set the outriggers.
3. See "Operation 2.19 Boom Derricking Operation" and raise the boom to the angle at which you can work without difficulty.
4. See "Operation 2.10 Stopping Engine" and stop the engine.
5. See "Operation 2.14 Outrigger Setting Operation" and rotate the rotary of all the outriggers outward.
6. Insert the key into the keyhole of the knob (2) of the engine hood (1) and unlock the hood (1) and unlock the hood.

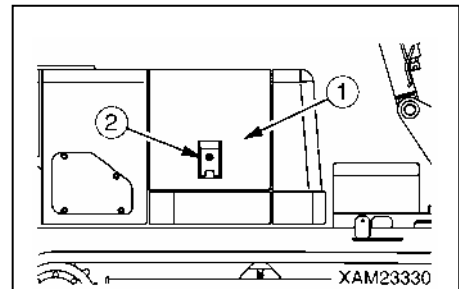

7. Open the engine hood (1) by pulling the knob (2) toward you. Slide the stay (3) and set it securely at the lock position (A).

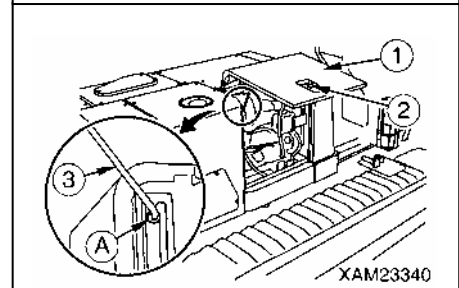

8. Remove the snap pin (4) and washer (5) from the stay (3) on the engine hood (1) side and separate the engine hood (1) from the stay (3).

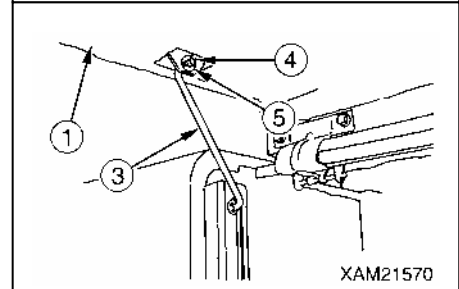

9. Remove six mounting bolts (7) on the top of the machinery cover (6).

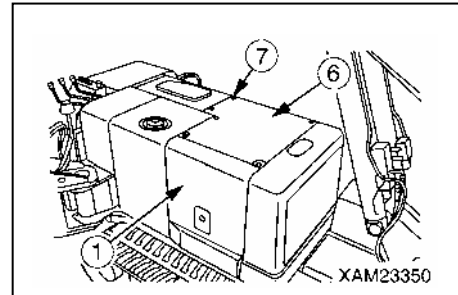

10. Remove two mounting bolts (7) on the left side of the machinery cover (6).

11. Pull up the machinery cover (6) and engine hood (1) together and remove them.

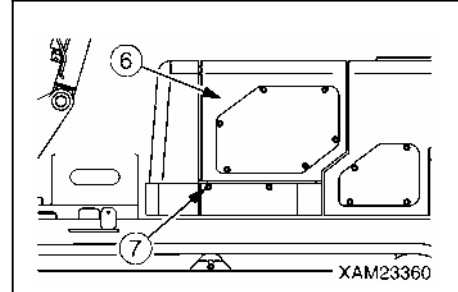

### **⚠ CAUTION**

**The machinery cover (6) and the engine hood (1) are connected with a hinge. Therefore, the two components bend at this section when removed. Be very careful when lifting the engine hood (1) side.**

## **[2] INSTALLING MACHINE COVER**

When you finished inspection/maintenance in the machinery cover, install the machinery cover using the following procedure.

1. Lift the machinery cover (6) and the engine hood (1) together to be replaced to the original position.

### **⚠ CAUTION**

**The machinery cover (6) and the engine hood (1) are connected with a hinge. Therefore, the two components bend at this section when removed. Be very careful when lifting the engine hood (1) side.**

2. Securely tighten eight mounting bolts of the machinery cover (6).

3. Set the stay on the engine hood (1) side to the connection of the engine hood (1), and install the washer (5) and the snap pin (4).

4. Lift the stay (3) of the engine hood (1) and pull it out of the lock position (A). Close the engine hood.

5. Lock the knob (2) of the engine hood (1) and remove the key.

6. See "Operation 2.24 Outrigger Stowing Operation" to rotate the rotary of all the outriggers inward and stow.

7. See "Operation 2.2 Starting Engine" and start the engine.

8. See "Operation 2.23 Crane Stowing Operation" and stow the boom.

9. Operate the emergency stop cancel switch to the "OFF" (auto) position and remove the key.

10. See "Operation 2.10 Stopping Engine" and stop the engine and remove the starter key.



## 2. OPERATIONS

### 2.1 CHECKING BEFORE OPERATION

#### 2.1.1 CHECKING BEFORE STARTING ENGINE (VISIBLE CHECKS)

##### **⚠ WARNING**

- This machine has a diesel engine.  
If it smells fuel around the engine, the fuel may be leaking. Carefully check the cracks on the fuel hose or fuel hose connections.
- Buildup of combustibles and oil leakage around the hot engine section such as engine and muffler and around the battery can cause fire in the machine.  
Carefully check around these areas. Should you find any abnormality, be sure to fix it or contact us or our sales service agency.

Check the items shown in this section as routine surveillance before starting the first work of every day.

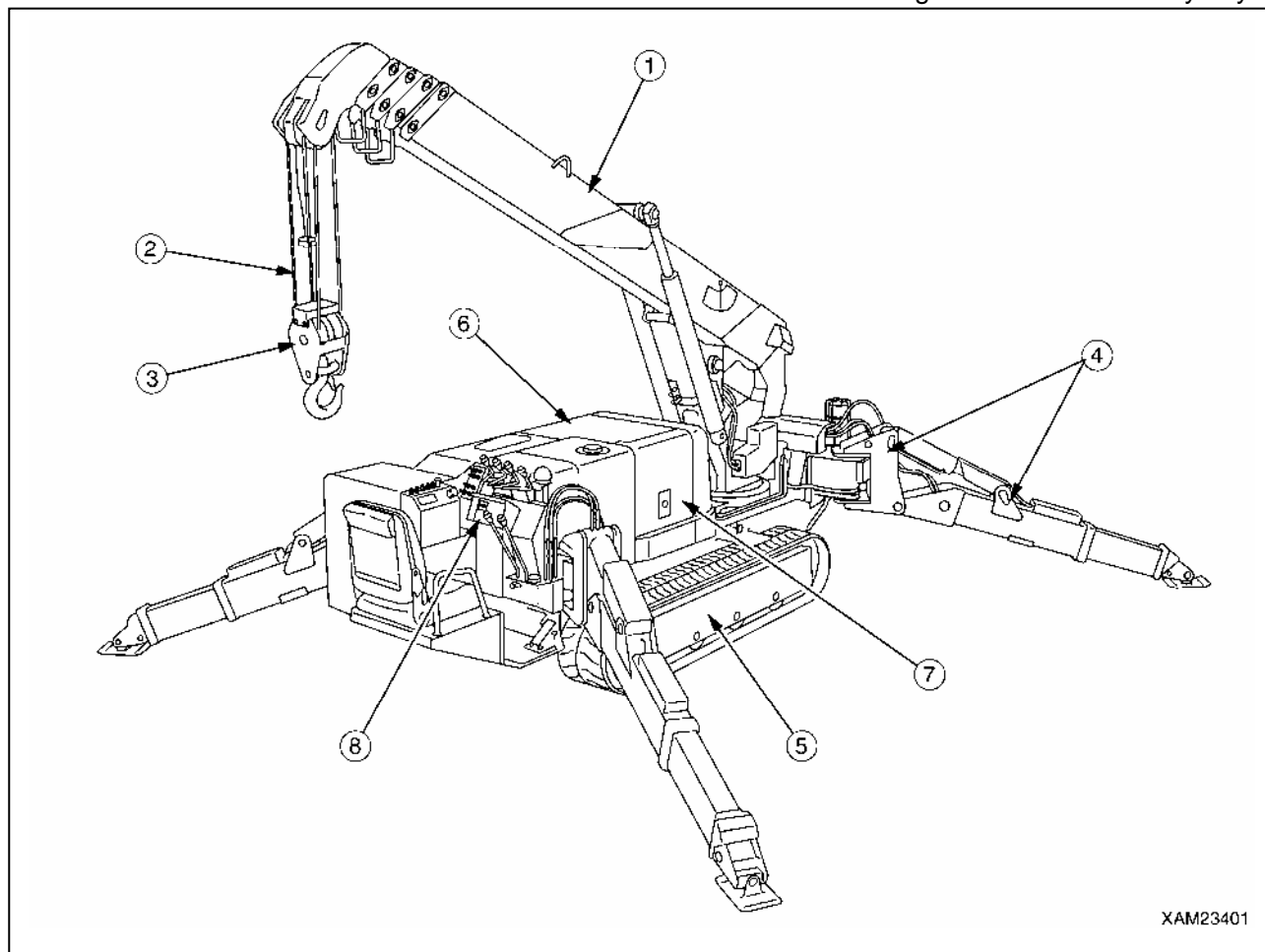

### [1] CHECKING AROUND CRANE

- Look around and below the boom and post and look for any oil leak or similar. Be especially careful to check up the derrick cylinder and lower part of the winch motor near the post. If you find any abnormality, repair.
- Check each part of the post for cracks, excessive deformation, contamination and others. In addition, check bolts, nuts, pins and piping joints for any looseness, drop, damage and other matters. Be especially careful to check for looseness of decelerator mounting bolt of the post, slewing ring or slewing device. If you find any abnormality, repair.
- Check each part of the boom for cracks, excessive deformation, contamination and others. In addition, check bolts, nuts, pins and piping joints for any looseness, drop, damage and other matters. Be especially careful to check for excessive abrasion and damage of the boom support pin or derrick support pin. If you find any abnormality, repair.
- Check for excessive damage and deformity of the over hoist weight wire rope of the overwinding alarm device at the tip of the boom. If there is any abnormality, repair.
- Check for sagged electrical wire, loosened connection and trace of burns. If you find any abnormality, repair.

### [2] CHECKING WIRE ROPES

★See " Operation 4. Handling Wire Ropes" for wire ropes.

- Check the wire ropes for damage, deformation, wear, twists, kinks, corrosion, etc. If you find any abnormality, replace
- Check the bound condition of the wire rope ends. If you find any loosened wire rope end, replace.
- Check for irregular winding of the wire ropes (wind drum). If you find any irregular winding, rewind.

### [3] CHECKING HOOK BLOCK

- Verify that the wire rope latch (1) functions normally. If there is any abnormality, repair.
- Rotate the hook and verify that the hook rotates smoothly and that trunnion does not emit any abnormal sound.  
If there is any abnormality, repair.
- Check the hook for any crack or excessive deformation.  
If there is any abnormality, repair.
- If dimension a between the punch marks punched on the hook became "105 mm or more" or the hook lower part dimension b became "49.5 mm or less", replace the hook.

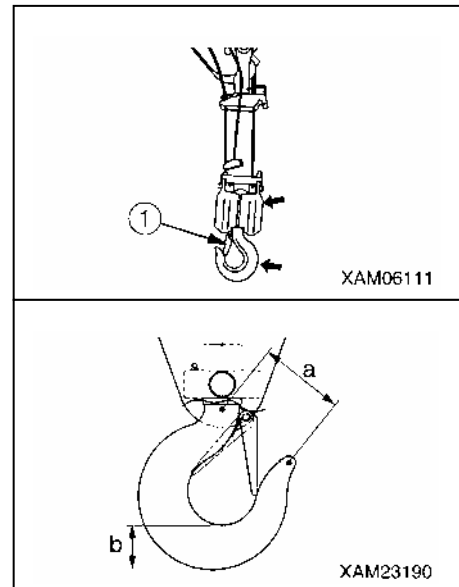

#### **[4] CHECKING AROUND OUTRIGGERS**

- Look below each of the outriggers and check for any oil leak or similar. Be especially careful to check below the outrigger cylinders. If you find any abnormality, repair.
- Check each of the rotaries, outriggers, holders and outrigger cylinders for cracks, excessive deformation, contamination and others. In addition, check bolts, nuts, pins and piping joints for any looseness, drop, damage and other matters. If you find any abnormality, repair.
- Check for sagged electrical wire, loosened connection and trace of burns. If you find any abnormality, repair.
- Pull out the position pin of each of the outriggers, rotate the relevant rotary and verify that the operation is smooth. If you find any abnormality, repair.

#### **[5] CHECKING UNDERCARRIAGE PARTS**

Check each of the frames, rubber tracks, rollers, idlers and sprockets for cracks, excessive deformation, contamination and others. In addition, check bolts, nuts and pins for any looseness, drop, damage and other matters. If you find any abnormality, repair.

#### **[6] CHECKING AROUND TRAVELING DOLLY**

- Look around and below the machine and check bolts, nuts, pins and piping joints for any looseness, drop, damage and other matters. If you find any abnormality, repair.
- Look around and below the machine and look for any oil leak or similar. Be especially careful to check below the hydraulic oil tank, travel/crane operation section and each traveling motor. If you find any abnormality, repair.
- Look around and below the Machine and check for breakage, excessive deformation, contamination and similar of lights such as the outrigger unset lamps and working status lamp. If you find any abnormality, repair.
- Look around and below the machine and check for sagged electrical wire, loosened connection and trace of burns. If you find any abnormality, repair.
- Check each of the frames, machinery covers, engine hood and other parts for cracks, excessive deformation, contamination and others. If you find any abnormality, repair.

#### **[7] CHECKING AROUND ENGINE**

- Check for fuel, oil or water leaking from the engine. If you find any abnormality, repair.
- Check the hot engine sections such as the engine muffler and around the battery for the buildup and deposit of combustibles such as dead leaves, paper wastes, dust, oil, and grease. If there is any, remove them.
- Check the starter, alternator, around battery and similar parts for sagged electrical cables, piping joints, and the trace of burn. If you find any abnormality, repair.

#### **[8] CHECKING AROUND TRAVEL AND CRANE OPERATION SECTION**

- Verify that all of the operation levers, traveling levers, traveling lock lever and acceleration pedal operate smoothly. If you find any abnormality, repair.
- Check the moment limiter display and the monitor panel on the instrument panel for damages and dirtiness. If you find any abnormality, repair. If dirty, clean.
- Verify that all of the switches on the outrigger operation panel and instrument panel operate smoothly. If you find any abnormality, repair.
- Check for sagged electrical wire, loosened connection and trace of burns. If you find any abnormality, repair.

## 2.1.2 CHECKING BEFORE STARTING ENGINE

Check the followings in this section without starting the engine and before starting the first work every day.

### [1] CHECKING/REFILLING ENGINE COOLING WATER

#### WARNING

**Do not check or refill the cooling water with the radiator cap removed. Always check and refill in the reserve tank. Heated cooling water may spout, causing burns.**

1. Stop the machine at leveled location.
2. See "Operation 1.9 Engine Hood" and open the engine hood.
3. Check the cooling water level in the reserve tank (1) to be between "FULL" and "LOW".
4. If the cooling water level is lower than the "LOW" level, use the following procedure to refill with tap water.
  - (1) Remove the cap (2) of the reserve tank (1) and fill water from the filler opening to the level "FULL".
  - (2) After refilling with cooling water, securely install the cap (2) of the reserve tank (1).

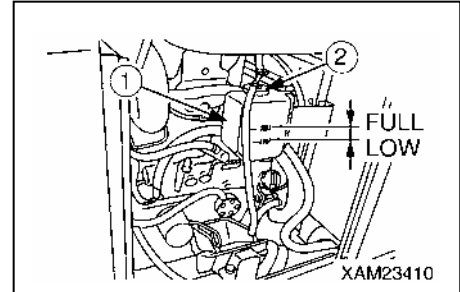

5. If the reserve tank was empty, follow the steps below.
  - (1) Remove two mounting bolts (4) and remove the cover (3).
  - (2) Remove the radiator cap (5) and check the cooling water level in the radiator.
  - (3) If the cooling water level in the radiator was low, check the radiator, radiator hose, and engine for water leakage.
  - (4) Fill water from the radiator filler opening and securely install the radiator cap (5).
  - (5) Remove the cap (2) of the reserve tank (1) and fill water from the filler opening to the level "FULL".
  - (6) After refilling with the cooling water, securely install the cap (2) of the reserve tank (1).
  - (7) Replace the cover (3) to the original position and securely tighten two mounting bolts (4).

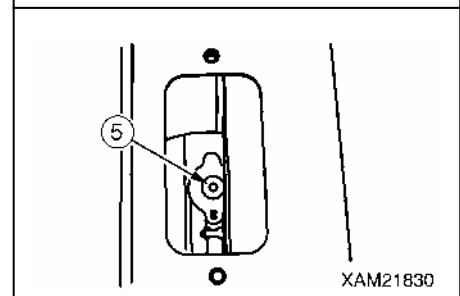
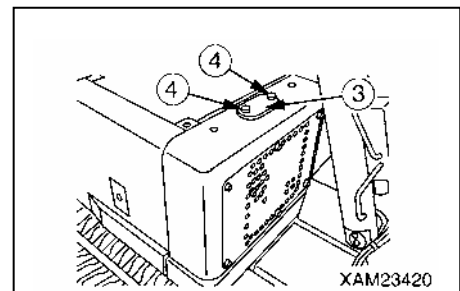

6. See "Operation 1.9 Engine Hood" and close the engine hood.

## [2] CHECKING/REFILLING OIL LEVEL IN ENGINE OIL PAN

### **⚠ CAUTION**

Securely install the oil level gauge and filler cap after checking the oil level and refilling with the oil. If the oil level gauge falls during the operation, the hot oil spouts out of the pan, causing burns.

### **CAUTION**

- See “Maintenance 5.1 Use of Lubricating Oil According to Temperature” for which oil to be used. Using other oil than those specified may shorten the life of the engine. Be sure to refill with the specified oil.
- Keep the engine oil at the appropriate level.  
The oil level being too high will result in too much oil consumption and this tends to increase the oil temperature, deteriorating the oil faster. The oil level being too low may burn out the engine.
- Be careful not to let any foreign substance go into the filler opening when refilling with the oil.

1. Stop the machine at leveled location.
2. See “Operation 1.9 Engine Hood” and open the engine hood.
3. Pull the oil level gauge (G) out and wipe the oil with a disposable cloth.
4. Insert the oil level gauge (G) into the gauge guide and pull it out.
5. If the oil level is between the “H” mark and “L” mark on the oil level gauge (G), the oil level is normal.
6. If the oil level is lower than the “L” mark, remove the filler cap (F) and refill with the engine oil from the filler opening.

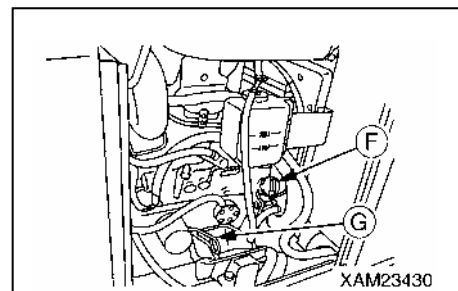

| <b>NOTES</b>  |
|---|
| Refill with the engine oil so that the oil level will be in the middle of the “H” and “L” marks on the oil level gauge (G). |

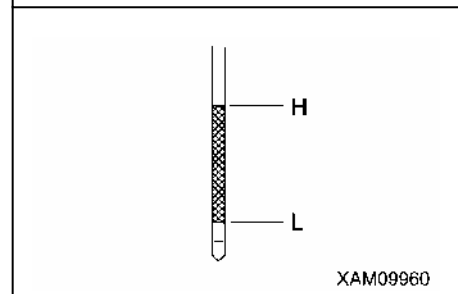

7. After refilling with the oil, securely install the oil level gauge (G) and the filler cap (F).
8. See “Operation 1.9 Engine Hood” and close the engine hood.

### [3] CHECKING/REFUELING FUEL LEVEL IN FUEL TANK

#### **⚠ DANGER**

- Be extremely careful with fire such as cigarette.
- Be sure to stop the engine when refueling. If refueling was done with the engine in operation, the fuel spilled on the section where it gets hot such as muffler can catch fire.
- Over-refilling may cause fuel spill. Refuel to the level slightly lower than the specified upper limit level. If the fuel spills, be sure to thoroughly wipe it off.
- Be sure to close the tank cap after refuelling.

#### **CAUTION**

- See “Maintenance 5.1 Use of Lubricating Oil According to Temperature” for which fuel to be used.
- Be careful not to let any foreign substance go into the filler opening when refueling.

1. Turn the starter switch to the “ON” position.

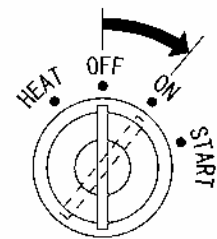

XAM22060

2. Looking at the fuel gauge on the monitor panel, check if the fuel is filled to almost full (around “F”).

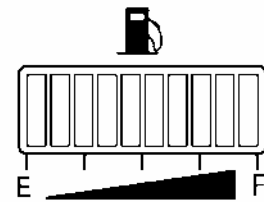

XAM09760

3. If the fuel level is low, remove the tank cap (F) on the top of the fuel tank and refuel from the filler opening while watching the fuel gauge.

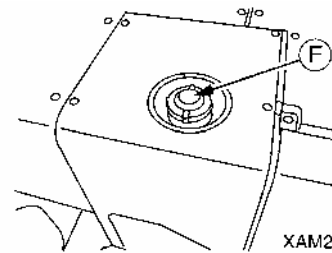

XAM23440

4. After refueling, turn the tank cap (F) to securely close it.

#### **NOTES**

Fill the fuel tank to full after finishing the work for the day.

#### [4] CHECKING/CLEANING WATER SEPARATOR

### ⚠ WARNING

- The water separator pot has fuel (diesel oil) inside. Be extremely careful of fire such as cigarette when cleaning the water separator pot.
- If the fuel spills when the water separator pot is removed, thoroughly wipe it off.

### CAUTION

- Water or dust accumulated inside the water separator pot will cause engine failure. Check inside the pot and remove any water or dust accumulated inside.
- If water remains in the water separator pot, it is assumed that much water is also mixed in the fuel tank. See “Maintenance 8.7 Maintenance for Every 50 Hours” and eliminate water and dust mixed into the fuel tank.

1. Stop the machine at leveled location.
2. See “Operation 1.9 Engine Hood” and open the engine hood.
3. Check the water separator pot (1) for any water or dust in the pot and verify if the red float (2) in the pot has not come up from the bottom.  
The red float (2) in the pot (1) coming up indicates that the water has mixed in.
4. If there is water accumulated in the pot (1), clean the inside of the pot using the following procedure.
  - (1) Raise the fuel lever (3) of the head (5) section to horizontal position (close) to shut off the fuel.
  - (2) Turn the retainer ring (4) of the head (5) section counterclockwise to loosen, then remove the pot (1) from the head (5) section.
  - (3) Drain the fuel and water out of the pot (1).
  - (4) Clean the pot (1) with diesel, and spray the compressed air (0.20 to 0.29 MPa {2 to 3 kg/cm<sup>2</sup>}) inside to scrape off the dusts from the surface.
  - (5) Set the pot (1) to the head (5) section, then turn the retainer ring (4) clockwise to tighten.
  - (6) Lower the fuel lever (3) of the head (5) section down to the vertical position (open) to open the fuel circuit.
5. See “Operation 1.9 Engine Hood” and close the engine hood.

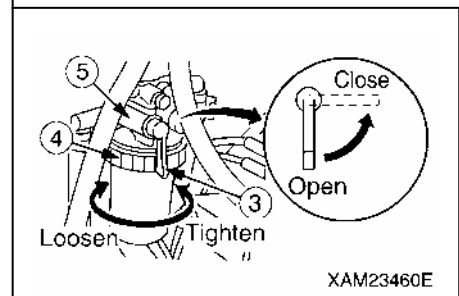
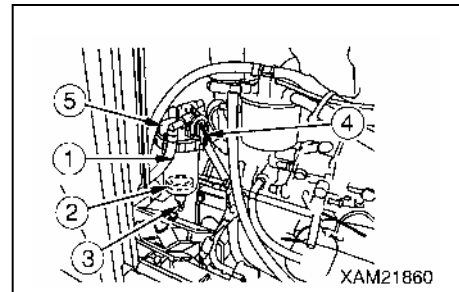

## [5] CHECKING/CLEANING FUEL FILTER POT

### ⚠ WARNING

- The fuel filter pot has fuel (diesel oil) inside. Be extremely careful of fire such as cigarette when cleaning the water separator pot.
- If the fuel spills when the fuel filter pot is removed, thoroughly wipe it off.

### CAUTION

- Water or dust accumulated inside the fuel filter pot will cause engine failure. Check inside the pot and remove any water or dust accumulated inside.
- If water remains in the fuel filter pot, it is assumed that much water is also mixed in the fuel tank. See “Maintenance 8.7 Maintenance for Every 50 Hours” and eliminate water and dust mixed into the fuel tank.

1. Stop the machine at leveled location.
2. See “Operation 1.9 Engine Hood” and open the engine hood.
3. Inspect the fuel filter pot (1) and check for water or dust accumulated inside the pot, and also for the dust or similar object blocking the element.
4. If water, dust or similar object is accumulated inside the pot (1), clean the inside of the pot using the following procedure.
  - (1) Raise the lever (2) of the head (4) section to horizontal position (close) to shut off the fuel.
  - (2) Turn the retainer ring (3) of the head (4) section counter clockwise to loosen, then remove the pot (1) from the head (4) section.
  - (3) Drain the fuel and water out of the pot (1).
  - (4) Clean the pot (1) and element with diesel, and spray the compressed air (0.20 to 0.29 MPa {2 to 3 kg/cm<sup>2</sup>}) inside to scrape off the dusts from the surface.
  - (5) Set the pot (1) to the head (4) section, then turn the retainer ring (3) clockwise to tighten.
  - (6) Lower the fuel lever (2) of the head (4) section down to the vertical position (open) to open the fuel circuit.
5. See “Operation 1.9 Engine Hood” and close the engine hood.

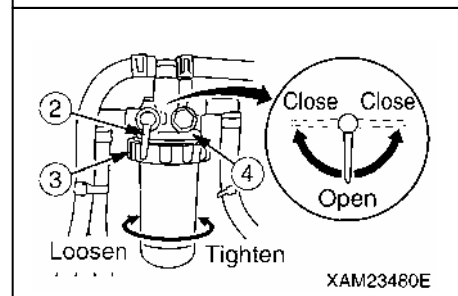
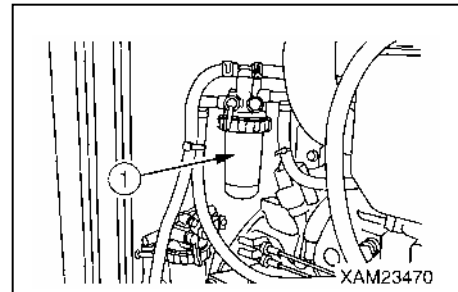



## [6] CHECKING/REFILLING OIL LEVEL IN HYDRAULIC OIL TANK

### ⚠ WARNING

- The oil may spout out when the cap of the hydraulic oil tank is removed. Turn the cap slowly to let the inner pressure escape before removing.
- Do not refill with the oil to the level higher than the “H” (upper limit) of the level gauge. Too much oil may cause the oil to spout out of the air breather during traveling or crane operation, causing burns.
- Be careful not to let dust go in from the filler opening when refilling with oil.
- Securely close the tank cap after refilling with the oil. The tank cap may fall, and the hot oil may spout out, causing burns.

### CAUTION

- See “Maintenance 5.1 Use of Lubricating Oil According to Temperature” for which oil to be used.
- Be sure to put the machine in the traveling posture when checking the oil level. Checking the oil level in the working posture will cause overfilling since the oil in the cylinders has not returned to the tank.
- Be careful not to let dust go in from the filler opening when refilling with oil.

1. Stop the machine at leveled location.
2. See “Operation 2.14 Outrigger Setting Operation” to rotate the rotary of the “outrigger (1)” and “outrigger (2)” outward.
3. Look at the oil level gauge (G) on the right side of the engine cover to check if the oil level is between “H” and “L”.
4. If there is not sufficient oil, refill with the hydraulic oil using the following procedure.
  - (1) Operate the emergency stop cancel switch to the “ON” (cancel) position.
  - (2) See “Operation 2.19 Boom Derricking Operation” and raise the boom to the height at which it is easy for you to work. Then stop the engine.
  - (3) Remove the three mounting bolts (2) and remove the inspection cover (1).
  - (4) Remove the filler cap (F) on the top of the hydraulic oil tank.
  - (5) Refill with the hydraulic oil from the filler opening (F) while looking at the oil level gauge (G).
  - (6) Securely close the filler cap (F) after refilling with oil.
  - (7) Replace the cover (1) to the original position and securely tighten three mounting bolts (2).
5. See “Operation 2.24 Outrigger Stowing Operation” and rotate the rotary of the “outrigger (1)” and “outrigger (2)” inward and stow.

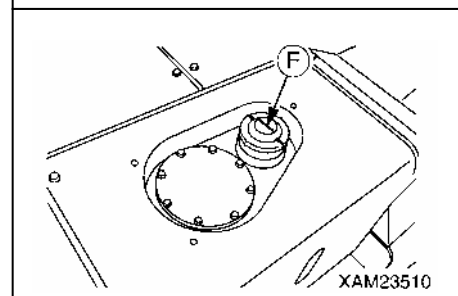
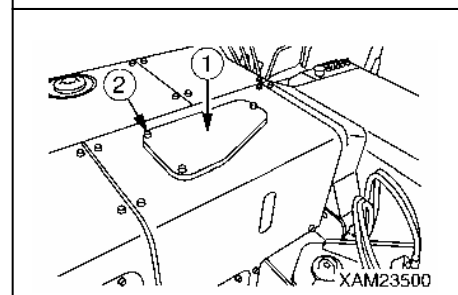
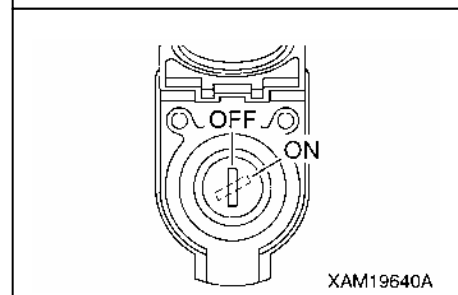
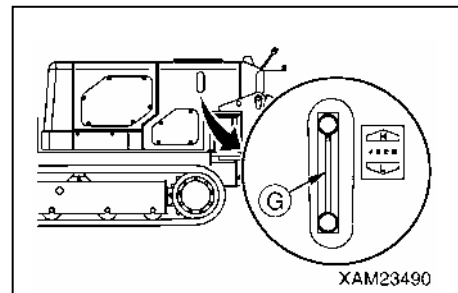

## [7] CHECKING/REFILLING OIL LEVEL IN SLEWING REDUCTION GEAR CASE

### CAUTION

- See “Maintenance 5.1 Use of Lubricating Oil According to Temperature” for which oil to be used.
- Use seal tape, etc. at the thread of the filler plug to stop the oil leak and securely tighten the plug after refilling with the oil.

1. Stop the machine at leveled location.
2. Go under the machine and check the site gauge (G) for checking oil level in the slewing reduction gear case. Verify that the oil is filled up to the center of the site gauge (G).

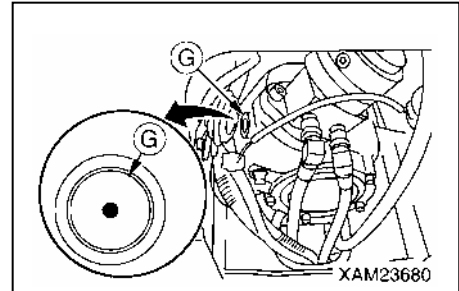

3. If there is not sufficient oil, refill with the gear oil using the following procedure.
  - (1) See “Operation 2.14 Outrigger Setting Operation” to rotate the rotary of the “outrigger (2)” outward.
  - (2) Remove the filler opening plug (F) at the back of the post and pour in oil from the filler opening.

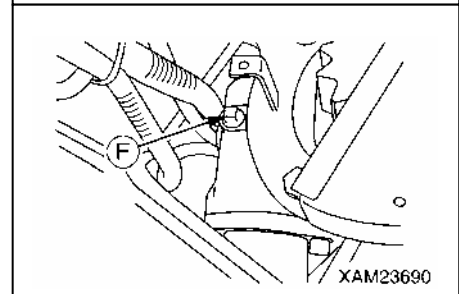

### NOTES

Pour in the oil to the center of the site gauge (G) from the filler opening.

- (3) After refilling with the oil, install the filler plug (F) and securely tighten the plug.
- (4) See “Operation 2.24 Outrigger Stowing Operation” and rotate the rotary of the “outrigger (2)” inward and stow.

## [8] CHECKING/REFILLING OIL LEVEL IN TRAVELING MOTOR REDUCTION GEAR CASE

### CAUTION

- See “Maintenance 5.1 Use of Lubricating Oil According to Temperature” for which oil to be used.
- Use seal tape, etc. at the thread of the oil level check plug to stop the oil leak and securely tighten the plug after refilling with the oil.

1. Move the machine forward and backward so that one of the two drain plugs (P) of the traveling motor reduction gear case will come right under.
2. Remove the oil level check plug (G) of the traveling motor reduction gear case to check if the oil will come out of the plug hole.
3. If there is no sufficient oil, remove the top drain plug (P) and pour in gear oil from the plug hole.

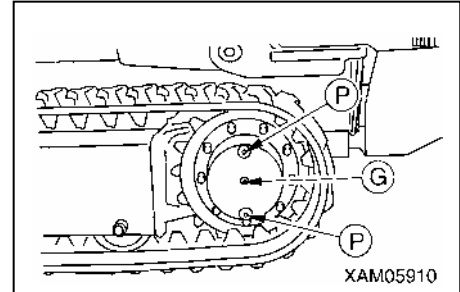

### NOTES

Pour in the gear oil until the oil comes out of the oil level check plug (G).

4. Install the oil level check plug (G) and upper drain plug (P) and securely tighten them after checking and refilling with the oil.

## [9] CHECKING/CLEANING RADIATOR AND OIL COOLER FINS

### ⚠ WARNING

The dusts fly in all directions when the compressed air is used. Always wear goggles and mask.

### CAUTION

- To prevent damage on the fins during the use of the compressed air, keep the pressure of the compressed air to 0.20 -0.29 MPa (2 – 3 kg/cm<sup>2</sup>) and apply it away from the fins. Damage on the fins will cause water leakage or overheating.
- At the dusty site, check the fins every day and clean as needed.

1. Stop the machine at leveled location.
2. See “Operation 2.14 Outrigger Setting Operation” to rotate the rotary of the “outrigger (1)” and “outrigger (4)” outward.
3. Remove the six mounting bolts (2) and remove the radiator cover (1).
4. Apply the compressed air (0.20 -0.29 MPa (2 – 3 kg/cm<sup>2</sup>)) to the oil cooler (3) and radiator (4) to remove the mud and dusts clogged in the fins.
5. Replace the radiator cover (1) to the original position and securely tighten the six mounting bolts (2) after cleaning.
6. See “Operation 2.24 Outrigger Stowing Operation” and rotate the rotary of the “outrigger (1)” and “outrigger (4)” inward and stow.

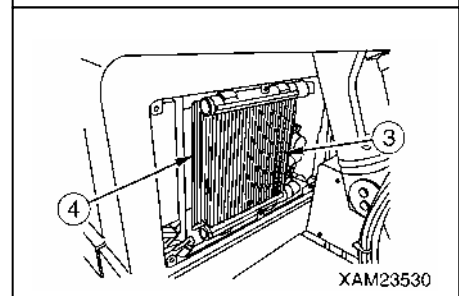
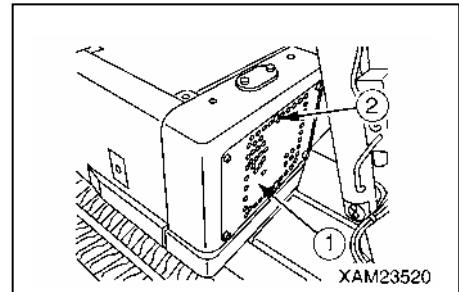

## [10] CHECKING/REFILLING BATTERY ELECTROLYTE LEVEL

### ⚠ WARNING

- The electrolyte generates combustible gas and presents explosion hazard. Do not bring any fire close to the electrolyte.
- The electrolyte is a hazardous substance. Avoid contact with eyes or skin. Should it come into the contact with eyes or skin, wash the affected area with plenty of water and consult a physician.
- Do not refill with the electrolyte above the “Maximum level line”.  
The fluid leakage can cause fire.

### CAUTION

- Wipe the top of the battery with moistened cloth to keep it clean.
- Distilled water should be refilled before starting the work next day to avoid freezing.

### [LEVEL CHECK]

1. Stop the machine at leveled location.
2. See “Operation 2.14 Outrigger Setting Operation” to rotate the rotary of the “outrigger (1)” and “outrigger (2)” outward.
3. Verify the electrolyte you can see through the side of the battery case from the side of the battery case.

### NOTES

Wipe the battery case clean if it is dirty.

4. Verify that the surface of the electrolyte is at the upper level line (1).

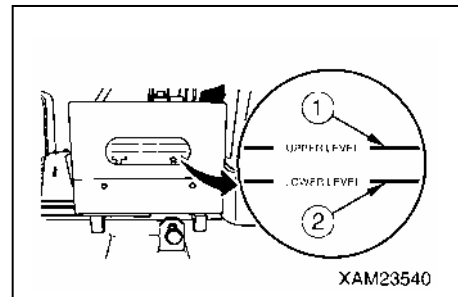

### [REFILLING WITH ELECTROLYTE]

If the surface of the electrolyte is not at the maximum level line (1), refill with the distilled water using the following procedure.

1. Remove the four mounting bolts (4) and remove the battery cover (3).

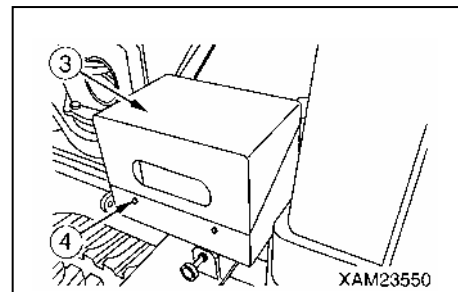

2. Remove all the six battery caps (5) and refill with the distilled water to the maximum level line (1).

### NOTES

Pour diluted sulfuric acid if you spilled the electrolyte.

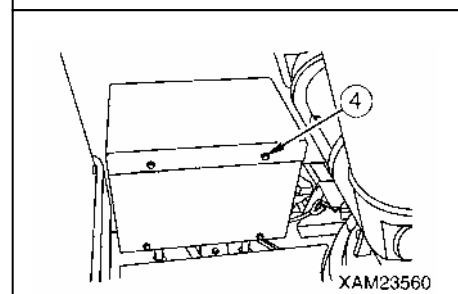

3. Check the ventilation hole (5) of the battery caps. Clean the cap if clogged, and securely tighten the caps.
4. Replace the battery cover (3) to the original position after refilling with the electrolyte, and securely tighten the four mounting bolts (4).
5. After refilling with the electrolyte, see “Operation 2.24 Outrigger Stowing Operation” and rotate the rotary of the “outrigger (1)” and “outrigger (2)” inward and stow.

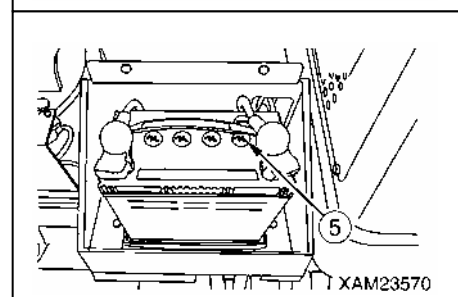

### [11] CHECKING HORN FOR OPERATION

1. Turn the starter switch to the "ON" position and check the followings.

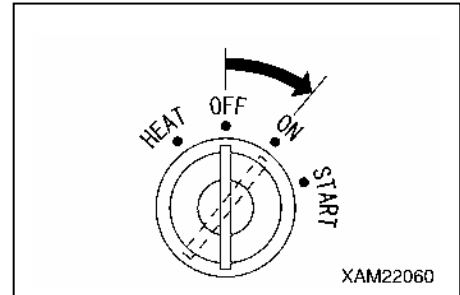

2. Press the horn switch to verify that the horn sounds.  
If not, the horn may be faulty or the circuit may be open.  
Ask us or our sales service agency for repair.

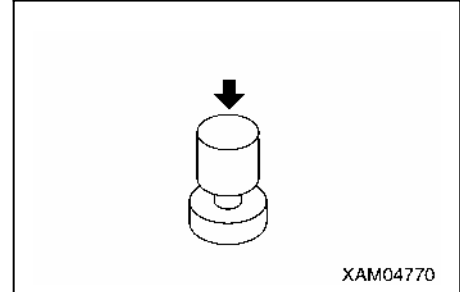

### [12] CHECKING HEADLIGHTS FOR OPERATION

1. Turn the starter switch to the "ON" position and check the followings.

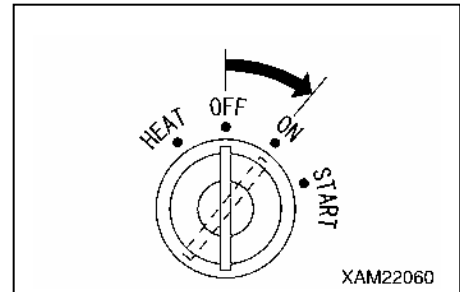

2. Push the headlight switch in the back and verify that the pilot lamp of the switch section and the headlight on front of the machine lights up.  
If it does not light up, the bulb may be burned or the circuit may be open. Ask us or our sales service agency for repair.

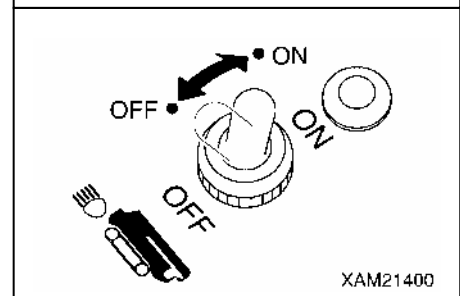

### [13] CHECKING FUSE BOX FOR DAMAGE

#### **⚠ WARNING**

**If fuses are brown frequently or if you find the trace of a short circuit created in the electrical wiring, be sure to find the cause and fix the problem.**

Check the fuse at the lower section of the instrument panel for damage and meltdown and if the fuse of specified capacity is being used.

If a fuse has melted down or the trace of an open/short circuit is found in the electrical wiring, ask us or our sales service agency for repair.

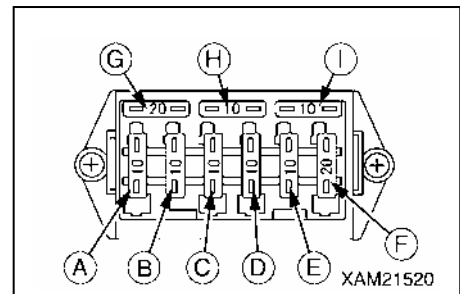

## [14] CHECKING OUTRIGGER DISPLAY FOR OPERATION

1. Turn the starter switch to the "ON" position.

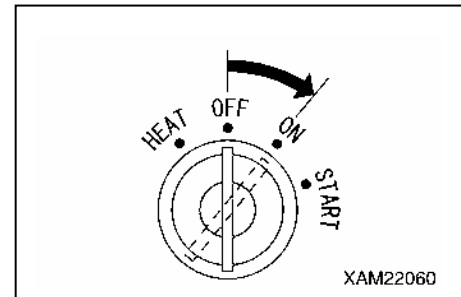

2. Operate the work selector switch on the outrigger operation panel to the "OUTRIGGER" position.

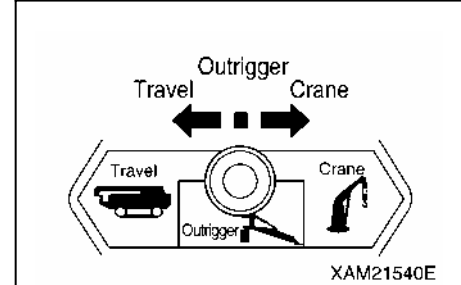

3. Verify that the lamps on the outrigger display light up and go off in the order shown below.

(1) All of the boom stowing lamp (1), extension lamps (2), and setting lamps (3) light up in green for 2 seconds, and go off.

(2) The boom stowing lamp (1) (green) lights up, and at the same time, all the extension lamps (2) and setting lamps (3) flash in red.

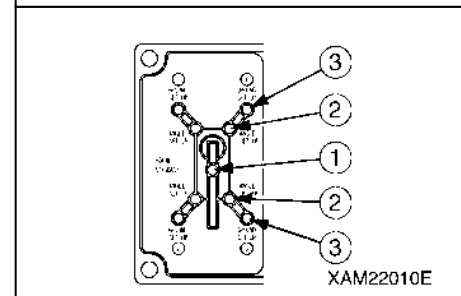

### NOTES

If a lamp on the outrigger display does not light up for 2 seconds in green, the outrigger display may be faulty. Please ask us or our sales service agency for repair.

4. Verify that the outrigger un-set warning lamp flashes and the red of the working status lamp lights up.

## [15] ADJUSTING OPERATION SEAT

### **⚠ WARNING**

- Adjust the operation seat before operation or when the operator changes.
- Press your back against the back of the operation seat and adjust the seat so that you can fully step on the acceleration pedal.

### [FORWARD/BACKWARD ADJUSTMENT OF THE SEAT]

1. While pushing the slide adjusting lever (1) to the left, set the seat to the desired position.
2. Release your hand from the slide adjusting lever (1).

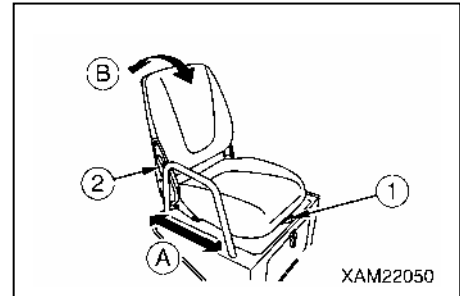

### **NOTES**

The forward/backward slide adjustment distance is 120 mm in 6 steps.

### [RECLINING ADJUSTMENT]

### **CAUTION**

**Watch the space in the back while adjusting the angle when reclining the backseat backward.**

1. While pushing the reclining adjusting lever (2) forward, set the backseat to the desired angle.
2. Release your hand from the reclining adjusting lever (2).

### **NOTES**

The reclining adjustment angle is 75 degrees in 7 steps forward and 23 steps in backward.



### 2.1.3 CHECKING AFTER STARTING ENGINE

Check the followings in this section after starting the engine and before starting the first work every day.

#### CAUTION

The checkups described in this section should be carried out after starting the machine. Refer to "Operation 2.2 Starting Engine" and later to execute the engine startup, traveling operations, outrigger operations and crane operations.

#### [1] CHECKING/ADJUSTING RUBBER TRACK TENSION

#### CAUTION

- Set the outriggers and raise the rubber track for about 50 mm from the ground when checking/adjusting the tension of the rubber tracks.
- The standard tension of the rubber track is that the clearance between the wheel tread of the track roller at center and the shoulder of the rubber track is 5 to 10 mm.
- If the tension is not sufficient even after injecting the grease, the rubber track or the sealing of the tension adjustment cylinder needs to be changed. Contact us or our sales service agency for the judgement of whether to replace, repair, or keep the rubber track.

The rubber tracks are worn out differently depending on the working conditions and soil quality. Regularly check the wear and tension of the rubber tracks.

Especially, with the new machine or when a new part was installed, "initial slack" appears with 5 to 30 hours of driving after adjusting the tension to the specified value.

Adjust the tension frequently until the period of "initial slack" passes. This will prevent "rubber track from coming off due to insufficient tension on the rubber track".

#### [TENSION CHECK]

1. Move the left and right crawlers so that the junction of the rubber track (indicated by M) comes to the top center between the axles.
2. See "Operation 2.14 Outrigger Setting Operation" to set the outriggers and raise the crawlers for about 50mm from the ground.
3. Measure the clearance between the wheel tread of the track roller at center and the shoulder of the rubber track.

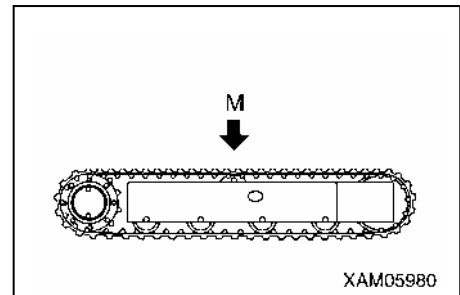

| NOTES   |
|---|
| The clearance of 5 to 10 mm indicates the standard tension. |

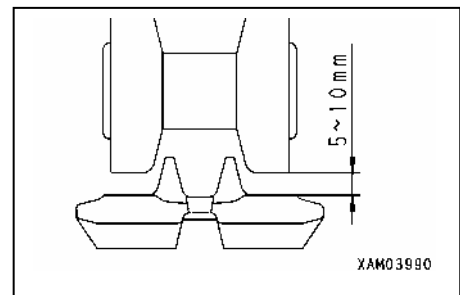

4. If the tension is out of the standard range, see the section of tension adjustment on the next page to make adjustments.

## [TENSION ADJUSTMENT]

If the “tension check” of the rubber track found the tension lower than standard tension of the rubber track, make adjustments as described below.

Working with the loose rubber track (the tension of the rubber track at 15 mm or more) will cause run-off or early wear of the core metal.

### • LOOSE TENSION (INCREASE TENSION)

- Have a grease gun (pump) ready.

1. Inject the grease from the grease valve (1) using the grease gun.

2. Perform the following tasks to verify the proper tension.

- (1) See “Operation 2.24 Outrigger Stowing Operation” to stow the outriggers and lower the machine on the ground.

- (2) Move the machine forward/backward.

- (3) See “Operation 2.14 Outrigger Setting Operation” to set the outriggers and raise the crawlers again for about 50mm from the ground.

3. Perform the “tension check” of the rubber track again.

If the tension is not appropriate, make another adjustment.

4. See “Operation 2.24 Outrigger Stowing Operation” to stow the outriggers and lower the machine on the ground.

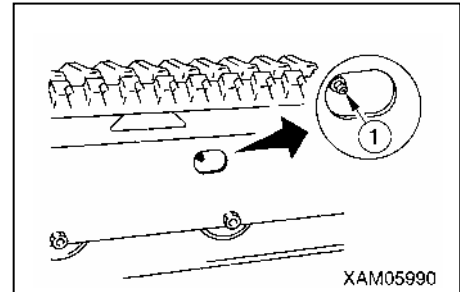

• TIGHT TENSION (DECREASE TENSION)

**⚠ WARNING**

Inside the rubber track tension adjustment device has the grease sealed. The grease is under high pressure due to the tension of the rubber track.

Making adjustments without observing the followings may cause the grease valve to fly away, resulting in serious accidents.

- Do not loosen the grease valve for tension adjustment for more than 1 turn. The grease valve may pop out.
- Do not place yourself right in front of the grease valve when adjusting the tension to avoid any danger.

1. Slowly loosen the grease valve (1) to drain the grease.

**NOTES**

When loosening the grease valve (1), do not loosen more than for one turn.

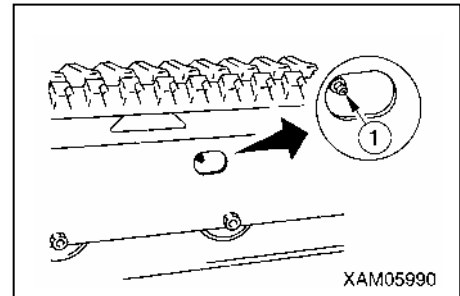

2. If the grease is not drained easily, perform the following to drain the grease.

- (1) See “Operation 2.24 Outrigger Stowing Operation” to stow the outriggers and lower the machine on the ground.
- (2) Move the machine forward/backward.
- (3) See “Operation 2.14 Outrigger Setting Operation” to set the outriggers and raise the crawlers again for about 50mm from the ground.

3. Tighten the grease valve (1).

4. Perform the “tension check” of the rubber track.

If the tension is not appropriate, make another adjustment.

5. See “Operation 2.24 Outrigger Stowing Operation” to stow the outriggers and lower the machine on the ground.

## [2] CHECKING RUBBER TRACKS FOR DAMAGE AND WEAR

### CAUTION

Contact us or our sales service agency for determining whether to replace, repair, or keep the rubber track.

The following condition requires the repair or replacement of the rubber track. Ask us or our sales service agency for repair/replacement.

#### [LUG HEIGHT]

- When the lug height “a” decreases with wear, the traction force drops.  
Replace the rubber track when the lug height decreases to 5 mm or lower with a new rubber track.

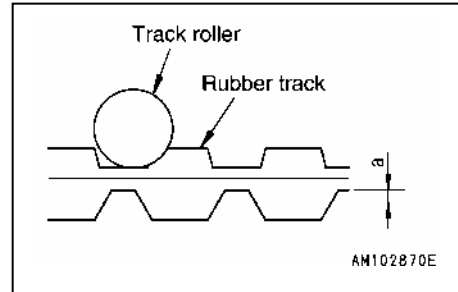

- When the lug is worn out and the steel cord inside the rubber track is exposed for more than 2 links, replace the rubber track with a new one.

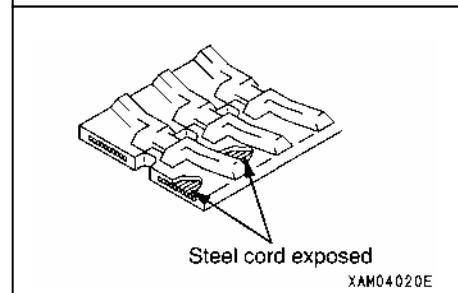

#### [BROKEN STEEL CORD]

- If more than half of the steel cord layer is broken on one side, replace the rubber track with a new one.

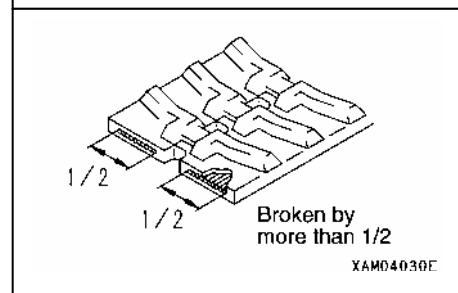

#### [FALLEN CORE METAL]

- If the core metal of the rubber track is fallen out at more than 1 location, change the rubber track with a new one.

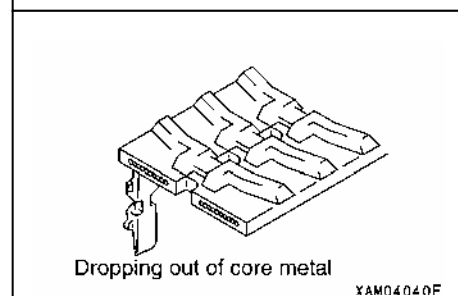

#### [CRACKS]

- If there is a crack between rubber track lugs, change the rubber track with a new one.

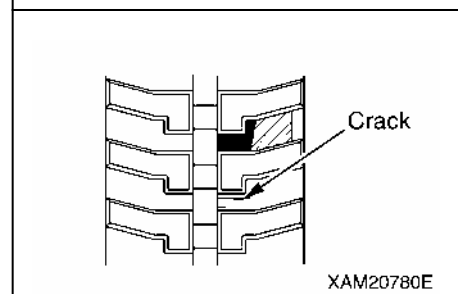

**[3] CHECKING OUTRIGGER SAFETY DEVICE FOR OPERATION**  
**[CHECKING OPERATION OF CRANE INTERLOCK FUNCTION]**

1. Turn the starter switch to the "ON" position.

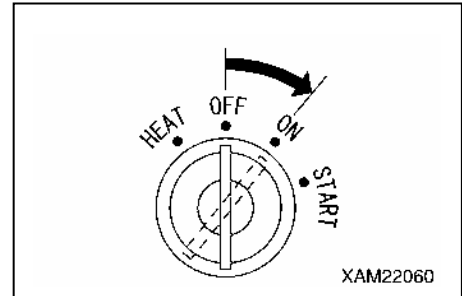

2. Operate the work selector switch on the outrigger operation Panel to the "OUTRIGGER" position.

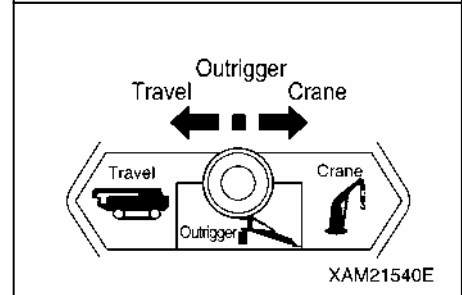

3. Verify that only the boom stowing lamp (1) (green) remains ON on the outrigger display.

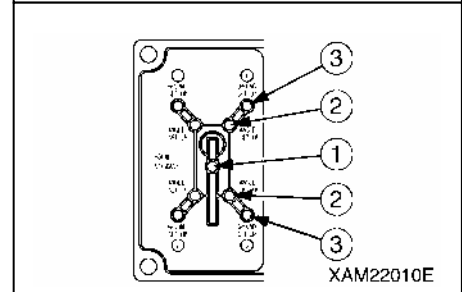

4. Rotate the rotary of all the four outriggers outward and properly insert the position pin (4).  
 Verify that all the extension lamps (2) light up on the outrigger display.

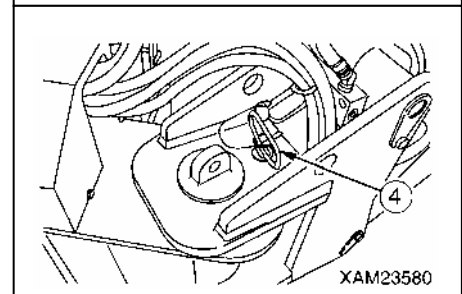

|   |
|---|
| <b>NOTES</b>  |
| Verify that the position pin (4) is properly inserted after outrigger rotary extension operation. |

5. Operate the outrigger setting switch (5) on the outrigger operation panel to "OUT" position and set all the four outriggers. Then set the tray securely.  
 Verify that all the setting lamps (3) on the outrigger display light up.

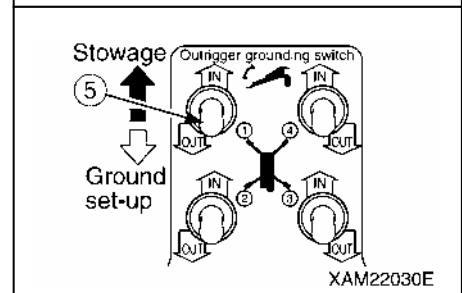

|   |
|---|
| <b>CAUTION</b>  |
| If any of the setting lamps (3) is flashing in red, remove the cover (7) of the outrigger tray (6) and check if there is any foreign object engaged in the bending section. |

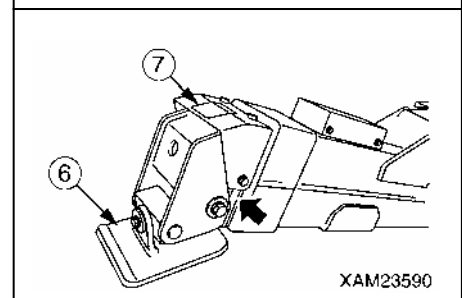

6. Operate one of the four outrigger setting switches (5) to “ON” position and raise the outrigger tray above the ground.

7. Operate the work selector switch on the outrigger operation panel to the “CRANE” position.

8. Operate the crane derricking lever to the “RAISE” side and verify that the crane does not operate.

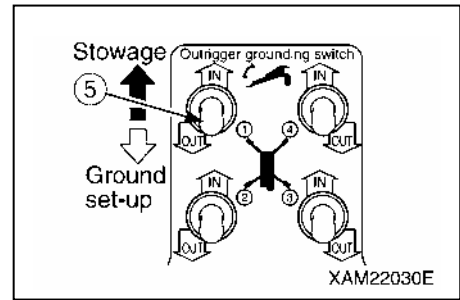

| <b>NOTES</b>   |
|--|
| Perform the tasks described in the step 6 to 8 to all the four outriggers. |

**[CHECKING OPERATION OF OUTRIGGER INTERLOCK FUNCTION]**

1. Set all the four outriggers.

2. Operate the work selector switch on the outrigger operation panel to the “CRANE” position.

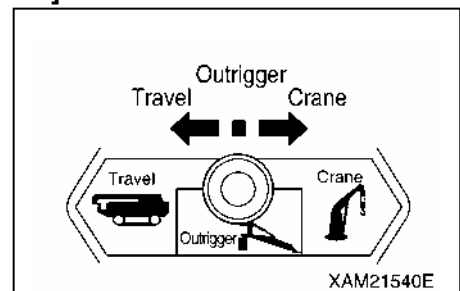

3. Operate the crane derricking lever to the “RAISE” side and raise the boom until the boom stowing lamp (1) on the outrigger display goes off.

4. Operate the work selector switch on the outrigger operation panel to the “OUTRIGGER” position.

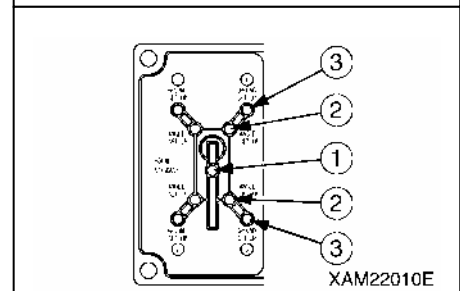

5. Operate the outrigger setting switch (5) on the outrigger operation panel to the “ON” position and verify that the outriggers do not operate.

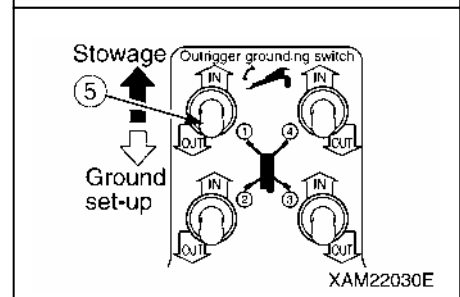

## [4] CHECKING OUTRIGGER OPERATION

### ⚠ WARNING

Be sure to refer to "Operation 2.14 Outrigger Setting Operation" and "Operation 2.24 Outrigger Stowing Operation", and strictly observe the methods described and cautions given when checking operations of the outriggers.

1. Verify that the outrigger inner box extends smoothly when the outrigger extension switch is pushed down to the "OUT" position. Also, verify that the inner box retracts smoothly when the outrigger extension switch is pushed down to the "IN" position. When doing the above, check for any abnormal noise generated by part of the outrigger. Operate the other switches likewise and check the operations. If there is any abnormality, repair.

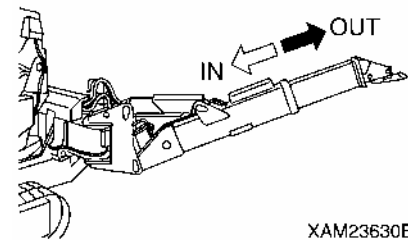
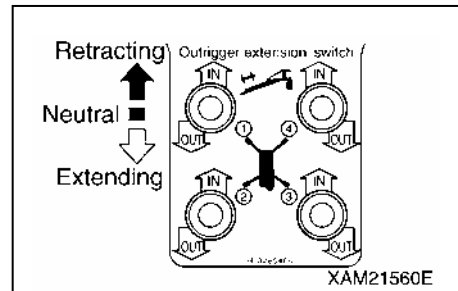

2. Verify that the outrigger lowers smoothly when the outrigger setting switch is pushed down to the "OUT" position. Also, verify that the inner box rises smoothly when the outrigger setting switch is pushed down to the "IN" position. When doing the above, check for any abnormal noise generated by part of the outrigger. Operate the other switches likewise and check the operations. If there is any abnormality, repair.

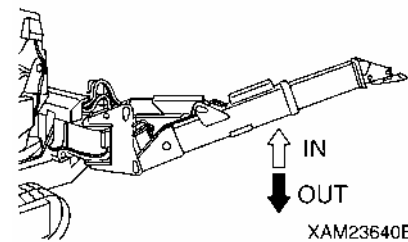
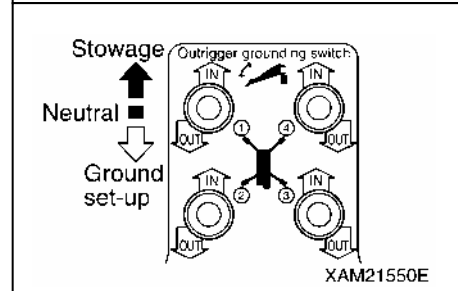

## [5] CHECKING CRANE OPERATIONS

### ⚠ WARNING

Be sure to set the outriggers by the maximum extension state by referring to " Operation 2.14 Outrigger Setting Operation" before checking the crane operations.  
Be sure to refer to the Operation sections between "2.15 Cautions before Crane Operation" and "2.23 Crane Stowing Operation", and strictly observe the methods described and cautions given when checking crane operations.

1. Operate the winch lever (3) to "DOWN" side to leave the hook block from the stow position.

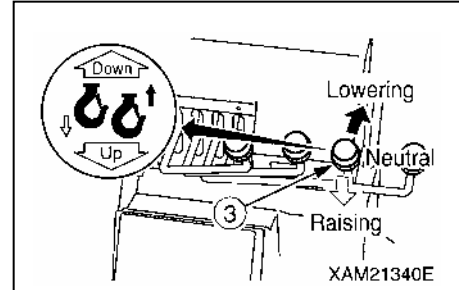

2. Verify that the boom rises smoothly when the boom derricking lever (4) is operated to "RAISE" side (pull toward you).  
Also, verify that the boom lowers smoothly when the boom derricking lever (4) is operated to "LOWER" side (push forward).  
When doing the above, check for any abnormal sound emitted by part of the boom or from the boom derrick cylinder.

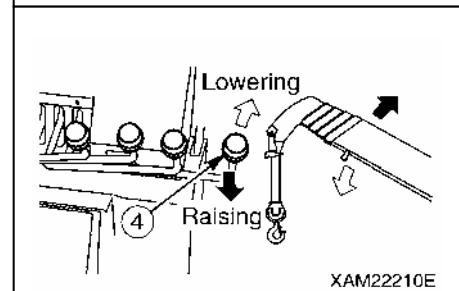

3. Verify that the boom extends smoothly when the boom telescoping lever (2) is operated to "EXTEND" (push forward).  
Also, verify that the boom retracts smoothly when the boom telescoping lever (2) is operated to "RETRACT" (pull toward you).

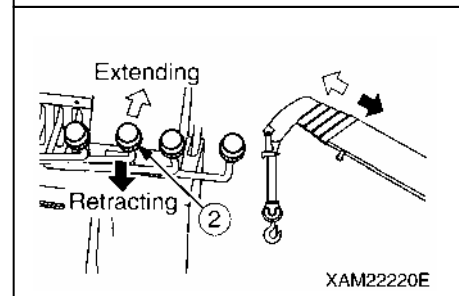

- When doing the above, check for any abnormal sound emitted by part of the boom or from the boom telescoping cylinder.

If there is any abnormality, repair.

4. Verify that the hook is wound down smoothly when the winch lever (3) is operated to "DOWN" (push forward).

Also, verify that the hook is wound up smoothly when the winch lever (3) is operated to "UP" side (pull toward you).

When doing the above, check for any abnormal sound emitted by part of the boom or from the winch motor.

If there is any abnormality, repair.

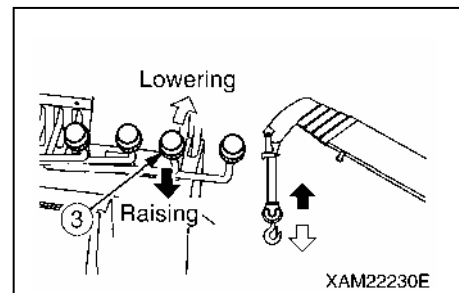

5. Verify that the crane smoothly slews counterclockwise when the slewing lever (1) is operated to "LEFT" side (push forward).

Also, verify that the crane smoothly slews clockwise when the slewing lever (1) is operated to "RIGHT" side (pull toward you).

When doing the above, check for any abnormal sound emitted nearby the post.

If there is any abnormality, repair.

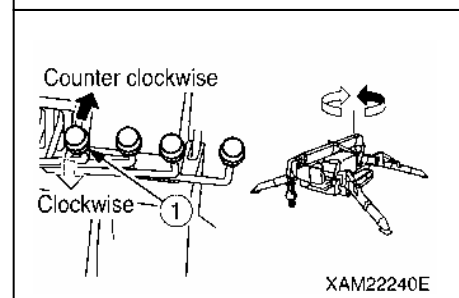



**[6] CHECKING OVER HOIST DETECTOR FOR OPERATION**

Over hoist the hook block (1), and raise the hook with winch and extend the boom, and verify that the buzzer sounds and an audible message saying "Over hoisted" is spoken, the hook raising operation and boom extending operation stop.

If these events do not happen, the over hoist detector may be faulty.

If the alarm does not stop, the over hoist detector may be faulty or the circuit may be open.

Ask us or our sales service agency for repair.

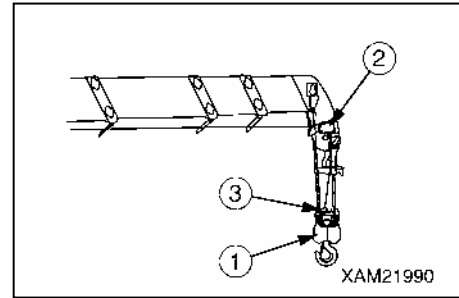

**NOTES**

If you do not hear the message from the speaker, check the volume of the remote controller.

**[7] CHECKING MOMENT LIMITER FOR OPERATION**

**⚠ WARNING**

**If you find any abnormality with the moment limiter, immediately contact us or our sales service agency.**

1. Turn the starter switch to the "ON" position.
2. Check with the working status lamp. The red of the lamp lights up for 2 seconds and then the green lights up.
3. Check the moment limiter display unit.  
Verify that no error code is displayed at the "RATED TOTAL LOAD" display on the display panel.
4. Start the engine and operate the crane as follows to verify if the moment limiter properly displays the value.

| Crane Operation and Displayed Parameter   | Value Displayed on Moment Limiter |
|---|-----------------------------------|
| Displayed "boom length" with the boom length at minimum   | 3.7 m                             |
| Displayed "boom length" with the boom length at maximum   | 12.5 m                            |
| Displayed "working radius" with the boom length of "5.9 m" (2-row booms) and boom angle of "57 °"   | 3.0 ± 0.1 m                       |
| Displayed "ACTUAL LOAD" when the weight of the known weight was hoisted<br>★Must be equal to the total weight of weight + rigging<br>★Note that it may show some errors depending on the boom conditions. | Actual load                       |

5. Operate the crane until the moment limiter display values indicate the boom length is "5.9 m" (booms (1) + (2)) and boom angle is "57 degrees", then measure the "boom angle" and "working radius".  
If the measured value(s) differ from the moment limiter display value, contact us or our sales agency.

### [8] CHECKING OUTRIGGER EXTENSION POSITIONS

Start the engine, execute each of the "MID" and "MAX" outrigger extension operations, and verify that the outrigger display on the moment limiter display section is proper in both case.

#### NOTES

Look to the sticker (MID, MAX) affixed to the top of the inner box when adjusting the outrigger extension.

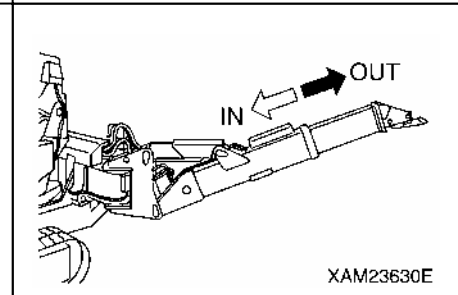
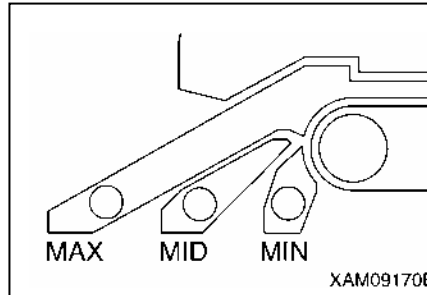
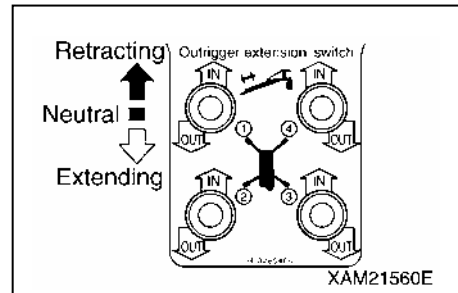

### [9] CHECKING ENGINE EXHAUST GAS COLOR, NOISE AND VIBRATION

1. Leave your foot away from the acceleration pedal (6). Keep the engine idling and continue the operation with no load for about 5 minutes.

2. Verify that the engine exhaust gas color is either transparent or slightly blue. Also, check for abnormal noises and vibrations. If there is any abnormality, repair.

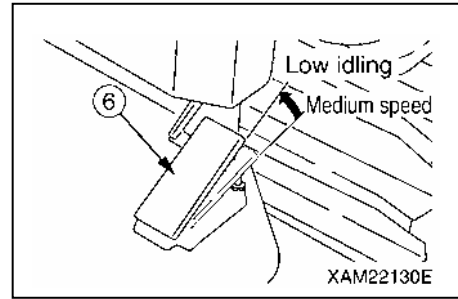

## 2.2 STARTING ENGINE

### **⚠ WARNING**

Verify that there is no one and obstacle around when starting the engine. Honk a horn and start the engine.

### 2.2.1 NORMAL ENGINE START

#### **CAUTION**

- If it is hard to start the engine due to low ambient temperature, see “Operation 2.2.2 Starting in cold weather” for the engine starting operation.
- Do not keep the starter turned for more than 5 seconds. Doing so will accelerate the battery discharge.  
Wait for about 1 minute before attempting to start the engine again if it did not start.
- Verify that the fuel lever of the water separator pot is at the vertical position (open) before starting the engine.
- Verify that the main switch on the remote control receiver is at the “OFF” position.

1. Lightly step on the acceleration pedal (6) to operate the engine at low speed.

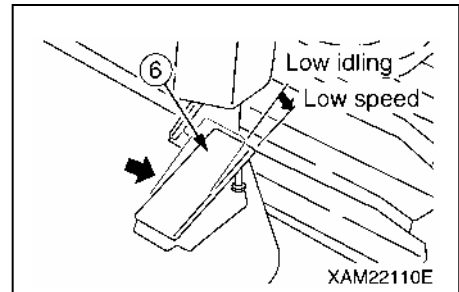

2. Insert the key into the starter switch and turn the key to the "START" position.

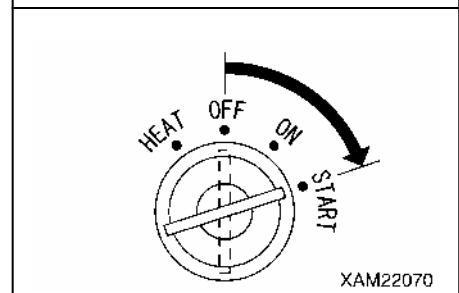

3. Release your hand from the key once the engine has started. The key will automatically return to the "ON" position.

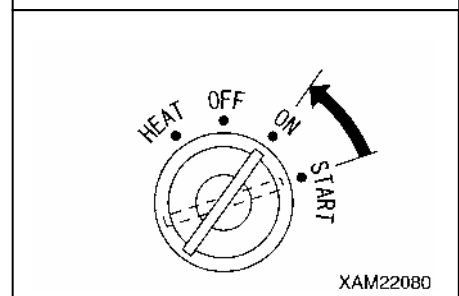

## 2.2.2 STARTING ENGINE IN COLD WEATHER

### CAUTION

- Do not keep the starter turned for more than 5 seconds. Doing so will accelerate the battery discharge.  
Wait for about 1 minute before attempting to start the engine again if it did not start.
- Verify that the fuel lever of the water separator pot is at the vertical position (open) before starting the engine.
- Verify that the main switch on the remote control receiver is at the “OFF” position.

Start the engine as follows when it is cold.

1. Insert the key into the starter switch and turn the key to “HEAT” (preheat) position. Keep the position until the “preheat monitor” goes off.

Release your hand, and the key will automatically return to the “ON” position.

### NOTES

When the starter switch is operated to the “HEAT” (preheat) position, the “preheat monitor” lights up, indicating that the engine is preheated.

When the engine preheating has completed, the “preheat monitor” goes off.

2. Step on the acceleration pedal (6) to the half of the full stroke and operate the engine at medium speed.

3. When the “preheat monitor” goes off, turn the key to the “START” position.

4. Release your hand from the key once the engine has started.  
The key will automatically return to the “ON” position.

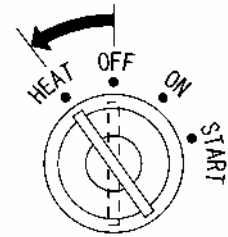

XAM22090

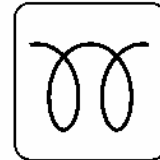

XAM21480

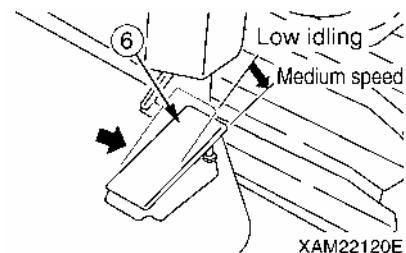

XAM22120E

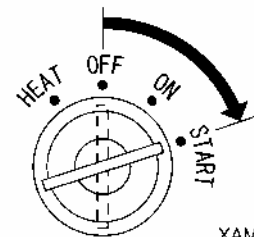

XAM22070

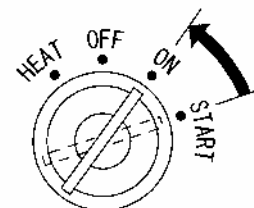

XAM22080

## 2.3 OPERATIONS AND CHECKS AFTER STARTING ENGINE

### **⚠ DANGER**

Never refuel (diesel oil) while the engine is in operation.  
Always stop the engine when refueling.

### **⚠ WARNING**

- If any abnormal condition takes place during the warm-up operation, immediately press the engine emergency stop switch to stop the engine for emergency. Then, turn the starter switch to the “OFF” position. The power to the electrical system will be shut off.
- Always perform the warm-up operation. The sufficient warm-up operation is necessary particularly when it is cold.  
Insufficient warm-up operation will slow down the movement response of the traveling system or crane system to the operation levers, resulting in serious accidents.
- Always check the operation of the crane after warm-up operation.  
Be careful not to let the hook block interfere or collide with the boom.
- Be careful not to let the boom hit the operator or this machine when slewing the boom.
- If you find any abnormality during the crane operation check, stop the machine immediately for emergency and repair.  
Using the system in abnormal condition can result in serious accidents.

### **CAUTION**

- The appropriate temperature of the hydraulic oil is 50 to 80 °C.  
Even when operating at low temperature by necessity, increase the temperature of the hydraulic oil to about 20 °C.
- Do not idle away suddenly until the warm-up operation is done.
- When the engine has started, check if the “battery charge monitor” and “engine oil pressure monitor” went off. If there is any abnormality, repair.
- Do not leave the engine in low idling or high idling for more than 20 minutes.  
If idling is necessary, apply load from time to time or operate at the medium engine speed.  
When using the engine at low speed, idle away the engine for about 5 minutes once a day.

Perform the warm-up operation as follows once the engine has started.

1. Leave your foot away from the acceleration pedal (6). Keep the engine idling and continue the operation with no load for about 5 minutes.
2. Check if there is any abnormality with the engine exhaust gas color, noise, and vibration.  
If there is any abnormality, repair.
3. Operate the work selector switch to the “OUTRIGGER” position.
4. See “Operation 2.14 Outrigger Setting Operation” and set the outriggers.
5. See “Operation 2.16 Operations before Crane Operation” to loosen the hook block from the stowing position.

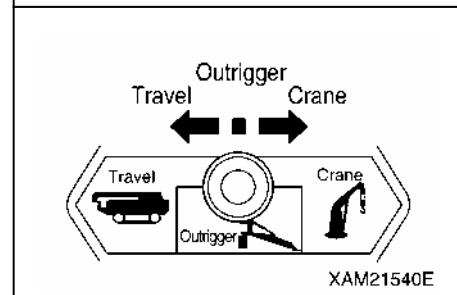
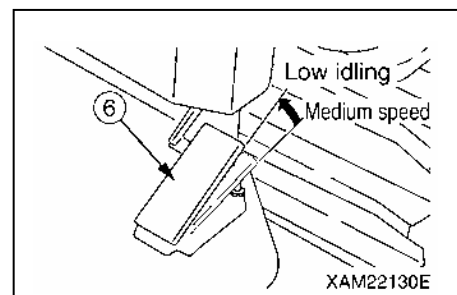

6. Step on the acceleration pedal (6) to the half of the full stroke and operate the engine at medium speed.

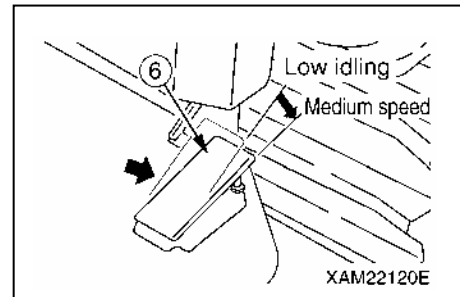

7. Operate the boom derricking lever (4) slowly forward/backward and move the derricking cylinder up/down until it reaches the stroke end. Check if there is any abnormality with the operation. If there is any abnormality, repair.

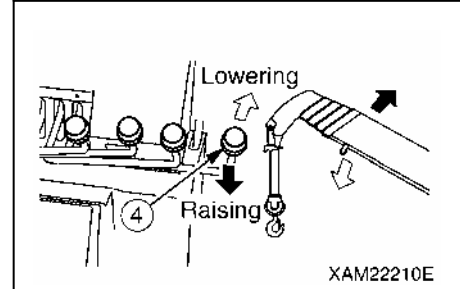

8. Operate the boom telescoping lever (2) slowly forward/backward to extend/retract the boom until it reaches the stroke end. Check if there is any abnormality with the operation. If there is any abnormality, repair.

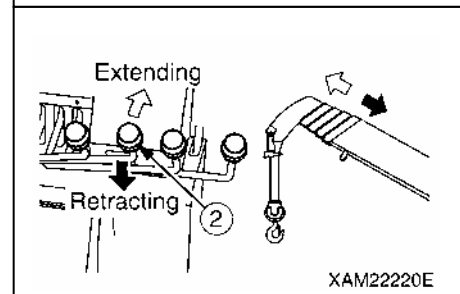

9. Operate the winch lever (3) slowly forward/backward to check if the hook block is smoothly raised/lowered. Also check if the hook block immediately stops and the winch drum does not wind in mess when the winch lever returns to the "NEUTRAL" position. If there is any abnormality, repair.

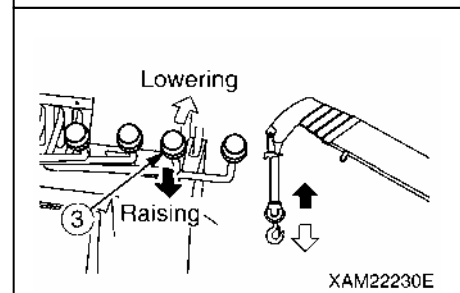

10. Operate the slewing lever (1) slowly forward/backward to check if the crane smoothly slews clockwise and counter clockwise for 360 degrees or more. Also check if the crane stops immediately when the slewing lever returns to the "NEUTRAL" position. If there is any abnormality, repair.

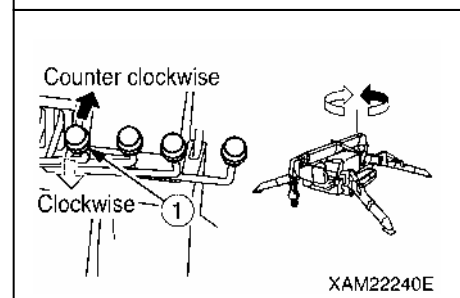

## 2.4 BREAKING-IN MACHINE

### **⚠ CAUTION**

Perform breaking-in for the period of about the first 250 hours (hours displayed on the service meter).

The life of the machine shortens if overloaded operation or task is performed before the various sections of the machine are used to the operation.

While this machine is shipped after thorough adjustment and inspection, forcing the machine from the beginning will quickly degrade the functions of engine and crane, shortening their life.

Perform the breaking-in for the first “250 hours” (time displayed on the service meter).

Pay attentions particularly to the followings during the breaking-in period.

- Be sure to perform the warm-up operation and avoid idling away after the engine has started.

See “Operation 2.3 Operations and Checks after Starting Engine”

- Avoid overloaded operation or tasks with high-speed operation.
- Avoid sudden starting, sudden acceleration, unnecessary sudden stop or sudden steering
- When the breaking-in period reaches “50 hours”, do not fail to change the engine oil.

See “Maintenance 8.2 [1] Replacement Engine Lubricating oil and Oil filter cartridge”.

The metal powder produced inside the engine through breaking-in increases in the engine oil and it deteriorates the oil, shortening the engine life.

## 2.5 MACHINE TRAVELING POSTURE

### **⚠ WARNING**

- When moving this machine self-propelled, take the “traveling posture” with which the boom, hook block, and outriggers are stowed.
- Traveling or traveling hoist with the boom extended is essentially prohibited. This will overturn the machine, causing serious injury accidents.
- Do not use this machine for other purpose than the major purpose such as using it for carrying the load on the machine.
- Follow the local laws and regulations if driving the machine on public roads.

Take the traveling posture shown on the right when moving the machine.

1. See “Operation 2.23 Crane Stowing Operation” to stow the crane. Stow the hook block in the specified position.
2. See “Operation 2.24 Outrigger Stowing Operation” to stow the outriggers.
3. Verify that the emergency stop cancel switch is at the OFF (auto) position.

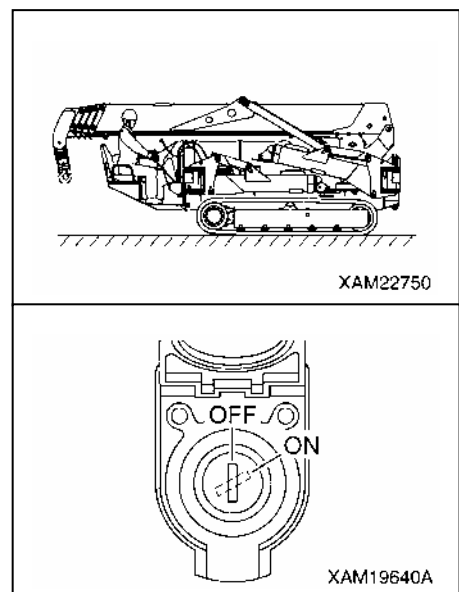

## 2.6 STARTING MOVING MACHINE

### ⚠ WARNING

- Do not allow anyone to come around the machine.
  - Put away all the obstacles on the traveling path.  
Check for projections and grooves on the traveling path especially when going backward. Fix the traveling path.
  - Check the safety around the machine and honk a horn before starting moving the machine.
  - Adjust the engine speed to low and operate the left and right traveling levers slowly at the same time. Check the traveling speed of the machine.
- Do not make sudden start especially when you are going backward. You can cause serious accidents.
- The front of the machine will be the blind corner. Be extremely careful when moving forward.
  - If you cannot verify the safety because the driving direction is the blind corner, stop driving and check the safety in the traveling direction. Staff a guide person if necessary depending on the work site situation.,
  - Operate the work selector switch to the “TRAVEL” position and the traveling lock lever to the “TRAVEL” position.

### [PREPARATION BEFORE STARTING MOVING]

1. Operate the work selector switch on the outrigger operation panel to the “TRAVEL” position.

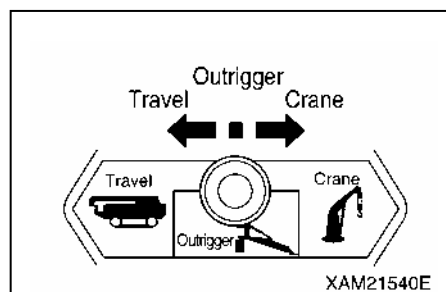

2. Push down the traveling lock levers (8) to the “TRAVEL” position.

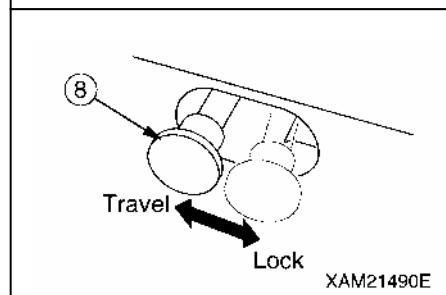

### [1] MOVING FORWARD

Operate the left and right traveling levers at the same time.

- Push the left and right traveling levers slowly forward to move forward.

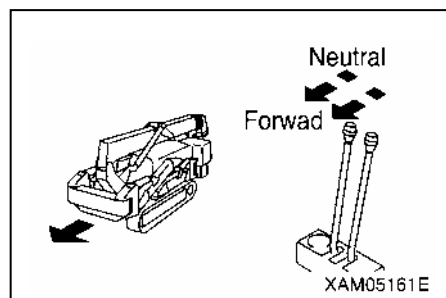

### [2] MOVING BACKWARD

Operate the left and right traveling levers at the same time.

- Pull the left and right traveling levers slowly toward you to move backward.

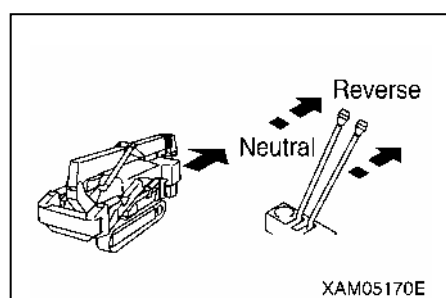



## 2.7 CHANGING MACHINE TRAVELING MODE

### **⚠ WARNING**

- Choose the appropriate traveling speed to the ground and road surface conditions while driving the machine.  
You can operate the traveling levers or choose “high-speed traveling mode” or “low-speed traveling mode” with the operation position of the traveling high-speed switch to change the traveling speed.
- Always set the traveling high-speed switch to the “OFF” (low speed) when driving on the slope. Driving on the slope in the high-speed traveling mode may cause overrun on the downward slope.
- Be sure to stop the machine before changing the traveling speed mode.

### [1] CHANGING TRAVELING SPEED MODE

Operate the traveling high-speed switch on the instrument panel.

- Push down the traveling high-speed switch to the back.  
The pilot lamp of the switch section lights up and the machine will be in the “high-speed traveling mode”.
- Push down the traveling high-speed switch toward you.  
The pilot lamp of the switch section goes off and the machine will be in the “low-speed traveling mode”.

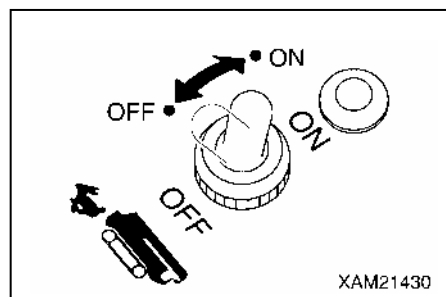

## 2.8 CHANGING PATH OF MACHINE

### **⚠ WARNING**

- Sudden steering or unnecessary spin turns at high speed not only damages the rubber track and hydraulic devices, but also may result in collision with other objects.  
Stop the machine, then adjust the engine speed to low speed before performing the spin turns.
- Do not change the path on the slope. The machine may slip to the side. Be especially careful on the soft ground and clay soil.

### [1] CHANGING THE MACHINE DIRECTION WHILE BEING STOPPED

#### • LEFT TURN

Operate the right traveling lever.

Tilt the traveling lever forward to turn to the left in the forward direction.

Tilt the traveling lever toward you to turn to the left in the backward direction.

#### • RIGHT TURN

Operate the left traveling lever.

Tilt the left traveling lever forward to turn to the right in the forward direction.

Tilt the left traveling lever toward you to turn to the right in the backward direction.

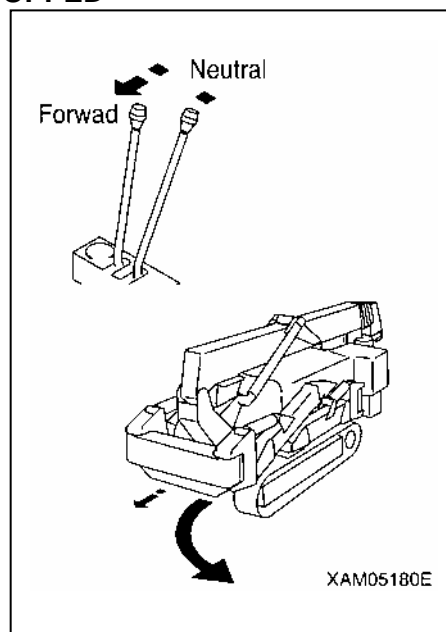

## [2] SPIN TURNS

### • LEFT SPIN TURN

Tilt the right traveling lever forward while tilting the left traveling lever toward you to rotate the left and right rubber tracks in the opposite direction for left spin turn.

### • RIGHT SPIN TURN

Tilt the left traveling lever forward while tilting the right traveling lever toward you to rotate the left and right rubber tracks in the opposite direction for right spin turn.

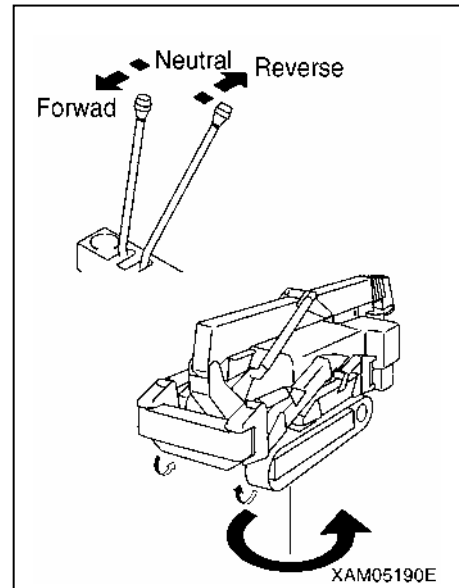

## [3] CHANGING PATH WHILE MOVING FORWARD/BACKWARD

### • LEFT TURN WHILE MOVING FORWARD

While tilting the right traveling lever forward, return only the left traveling lever to the "NEUTRAL" position.

### • LEFT TURN WHILE MOVING BACKWARD

While tilting the right traveling lever toward you, return only the left traveling lever to the "NEUTRAL" position.

### • RIGHT TURN WHILE MOVING FORWARD

While tilting the left traveling lever forward, return only the right traveling lever to the "NEUTRAL" position.

### • RIGHT TURN WHILE MOVING BACKWARD

While tilting the left traveling lever toward you, return only the right traveling lever to the "NEUTRAL" position.

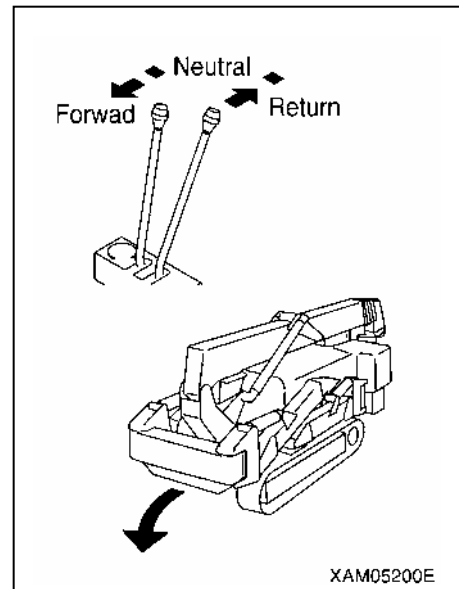

## 2.9 STOPPING/PARKING MACHINE

### **⚠ WARNING**

- Avoid sudden stop and try to stop with margin whenever possible.
- Choose leveled and solid location for parking the machine.  
If you park on the slope by necessity, provide some break so that the machine will not move.
- Careless contact with the traveling lever(s) during the engine operation may result in sudden movement of the machine, leading to serious accidents.  
Always set the traveling lock lever to the “LOCK” position when parking the machine.
- Stop the engine and always remove the key for the starter switch. Bring the key with you when you leave the machine.

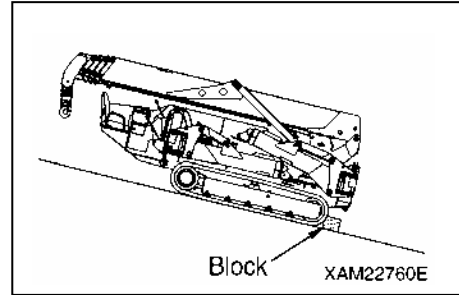

1. Operate the left and right traveling levers to the “NEUTRAL” position at the same time.  
This automatically brakes the machine and the machine stops.

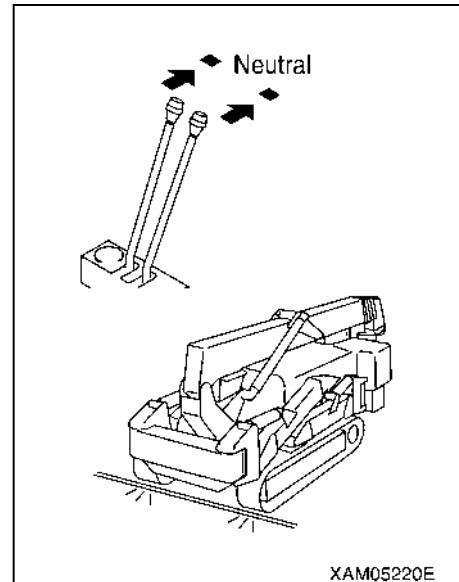

2. Knock down the traveling lock lever (8) to the “LOCK” position.

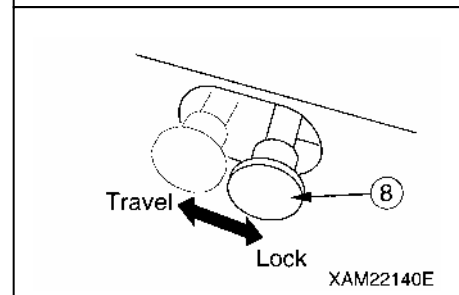

## 2.10 STOPPING ENGINE

### CAUTION

- Stopping the engine before it sufficiently cools down may shorten the life of engine units. Do not stop the engine suddenly except for emergency.
- When the engine is overheated, do not stop the engine suddenly. Change the engine speed to low speed, and gradually cool down the engine before stopping the engine.
- Verify that the main switch at the remote controller control box unit is at the “OFF” position.

1. Release your foot from the acceleration pedal (6) and change the engine speed to idling. Continue the no-load operation for about 5 minutes.

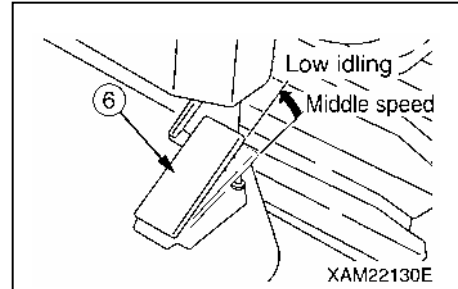

2. Turn the starter switch key to the “OFF” position. The engine will stop.

3. Remove the starter switch key.

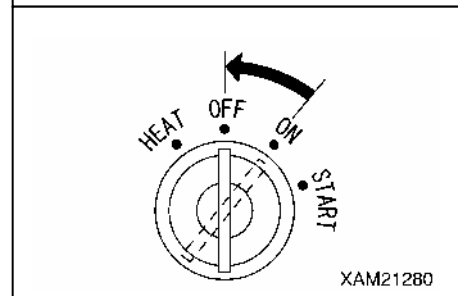

## 2.11 INSPECTION AFTER STOPPING ENGINE

1. Visibly check for oil leakage, fuel leakage, and water leakage, and check around the crawlers, crane, and exterior of the machine. If you find any leakage or abnormality, fix the problem.
2. Top off the fuel tank.
3. Dead leaves and papers around the engine will cause fire. Remove the dead leaves and papers.
4. Clean off mud on the crawlers and outriggers.

## 2.12 CAUTIONS IN DRIVING

### **⚠ WARNING**

Not observing these cautions in driving will result in serious accidents.

#### **[1] CAUTIONS IN DRIVING**

- When traveling, stow hook and outrigger, and make sure the surrounding safety.
- When stowing outriggers, insert each position pins completely to lock.
- Be seated to operate traveling.
- Driving over the boulder stones or a stump not only causes the overturning of the machine, but also gives an impact to the machine (especially around crawlers), causing breakage. Avoid or remove the obstacles not to travel over it whenever possible.

If you have to travel over the obstacles by necessity, be sure to take the “traveling posture” to lower the center of gravity, and reduce the traveling speed as much as possible so that the machine will go over the obstacles at the center of the crawlers.

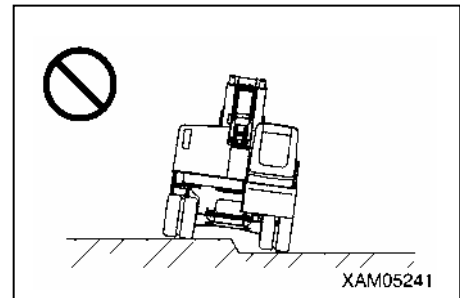

#### **NOTES**

See “Operation 2.5 Machine Traveling Posture” for the traveling posture of the machine.

#### **[2] ALLOWABLE WATER DEPTH**

Use this machine in the water of the depth of under the center of the idler (1) where the muffler beneath the machine body doesn't go inder water.

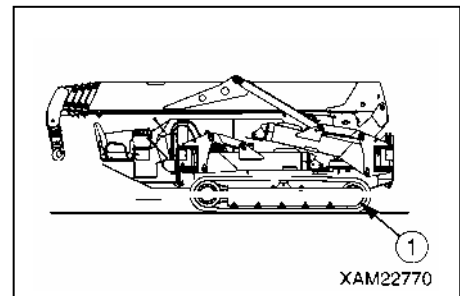

### [3] CAUTIONS ON UPWARD/DOWNWARD SLOPE

#### **⚠ WARNING**

- If the machine tilts for “15 degrees” or more forward, backward, leftward, or rightward while traveling, the machine may overturn. Do not travel on the slope of more inclination.
- Be sure to switch the traveling high-speed switch to the “OFF” (low speed) position when driving on the slope. Driving on the slope in the high-speed traveling mode may result in overrun on the downward slope.

- The slopes inclined for 15 degrees or more presents overturning hazard. Do not travel on these slopes.
- Be sure to switch the traveling high-speed switch to the “OFF” (low speed) position when driving on the slope. The machine may overrun.
- Never change the direction on the slope or cut the slope horizontally.  
Travel safely such as by going down to the level ground and taking a detour.
- Operate the acceleration pedal and traveling levers to decrease the traveling speed as much as possible when going down the slope.  
Operating the traveling lever to the “NEUTRAL” position automatically brakes the machine, but may overrun when going down the slope at high speed.
- Direct the machine perpendicular to the slope and the operation seat must be the side of the uphill when driving on the slope.
- If the engine stops on the slope, return the traveling levers to the “NEUTRAL” position and start the engine.

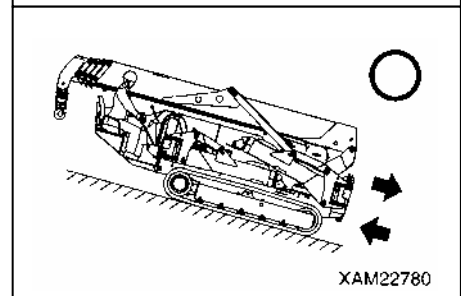
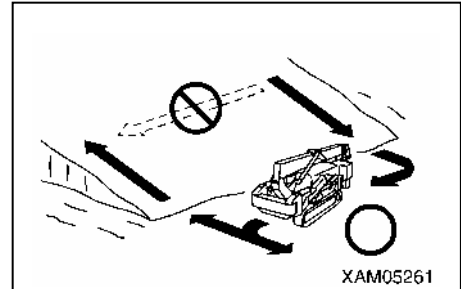

## 2.13 DESCRIPTION ON OUTRIGGER AND CRANE SAFETY DEVICES

### WARNING

Understand well the operation sequence below, warning display from the safety devices under the corresponding machine conditions, and the details of operation stop. Keep these in mind for safe operations.

The table below shows what kind of “display and warning” will be issued and the resulting action of the safety devices when this machine is used in the standard condition.

The standard operation sequence shown here is as follows.

[1] Check before setting outriggers ⇒ [2] Outrigger setting operation ⇒ [3] Crane operation ⇒ [4] Crane stowing operation ⇒ [5] Outrigger stowing operation ⇒ [6] Machine traveling operation

The columns of the table below are described below.

| Standard Operation Sequence, Machine Status   | Display and Warning   | Activation of Safety Devices  |
|---|---|---|
| This field shows the standard operation sequence and the operation position of operation levers and switches, and machine status. | This field shows the “display” and “warning” issued as a result of the operation. | This field shows the name of the safety device that prevents the resulted error and its action. |

### [1] CHECK BEFORE SETTING OUTRIGGERS

| Standard Operation Sequence, Machine Status  | Display and Warning  | Activation of Safety Devices   |
|--|--|--|
| <ul style="list-style-type: none"> <li>Start the engine</li> <li>Traveling lock lever at “LOCK” position</li> </ul>  |  |  |
| Check if the machine is in the posture of stowing the boom <ul style="list-style-type: none"> <li>Fully retract the boom</li> <li>Boom horizontal stowing position</li> <li>Boom slewing stowing position</li> </ul> | <ul style="list-style-type: none"> <li>Boom stowing lamp on display panel ON</li> <li>[Outrigger un-set warning lamp flashes]</li> <li>[Working status lamp (red) ON]</li> </ul> | Outrigger interlock device <ul style="list-style-type: none"> <li>All the outrigger operations stop if the boom stowing lamp does not light up.</li> </ul> |

### [2] OUTRIGGER SETTING OPERATION

| Standard Operation Sequence, Machine Status   | Display and Warning  | Activation of Safety Devices   |
|---|--|--|
| Set the outriggers. <ol style="list-style-type: none"> <li>Extend the outriggers.               <ul style="list-style-type: none"> <li>Rotate the outrigger rotary and secure them at the specified position with the position pin</li> <li>Work selector switch “OUTRIGGER”</li> <li>Outrigger extension switches “OUT”</li> </ul> </li> </ol> | <ul style="list-style-type: none"> <li>Extension lamps on display panel ON</li> <li>[Outrigger un-set warning lamp flashes]</li> <li>[Working status lamp (red) ON]</li> </ul> | Outrigger interlock device <ul style="list-style-type: none"> <li>All the outrigger operations stop if one of the four extension lamps does not light up.</li> </ul> |
| <ol style="list-style-type: none"> <li>Set the outriggers.               <ul style="list-style-type: none"> <li>Outrigger setting switch “OUT”</li> <li>Check the level with the level.</li> </ul> </li> </ol>  | <ul style="list-style-type: none"> <li>Setting lamps on display panel ON</li> <li>[Outrigger un-set warning lamp OFF]</li> <li>[Working status lamp (red) OFF]</li> </ul>      |  |
| When the machine tilts for 3 degrees or more during outrigger setting operation   | <ul style="list-style-type: none"> <li>Warning buzzer sounds continuously</li> </ul>   | Crane inclination alarm device is activated  |

**[3] CRANE OPERATIONS**

| Standard Operation Sequence, Machine Status  | Display and Warning   | Activation of Safety Devices   |
|--|---|--|
| <p>Perform crane operations.</p> <ul style="list-style-type: none"> <li>• Work selector switch “CRANE”</li> <li>• Crane operation with levers</li> </ul> | <ul style="list-style-type: none"> <li>• Boom stowing lamp on display panel OFF</li> <li>• Actual work and the rated total load are compared, and the working status lamp lights up according to the load factor.</li> <li>• Load factor for illuminating working status lamp               <ul style="list-style-type: none"> <li>• Load factor less than 90 %: Working status lamp (green) ON</li> <li>• Load factor 90 to less than 100 %: Working status lamp (yellow) ON, alarm sounds intermittently.</li> <li>• Load factor 100 % or more: Working status lamp (red) ON, alarm sounds continuously.</li> </ul> </li> </ul> | <p>Moment limiter</p> <ul style="list-style-type: none"> <li>• When the load factor reaches 100 % or more (overloaded), hook raising, boom extending, and boom lowering operation stop.</li> </ul>                           |
| <p>When one of the outriggers go up in the air during crane operation</p>  | <ul style="list-style-type: none"> <li>• Setting lamps (red) on display panel flash</li> </ul>  | <p>Crane interlock device</p> <ul style="list-style-type: none"> <li>• If any of the extension lamps and setting lamps (total of eight) goes off, hook raising, boom extending, and boom lowering operation stop.</li> </ul> |
| <p>When the hook was raised excessively</p>  | <ul style="list-style-type: none"> <li>• Alarm buzzer sounds continuously</li> </ul>  | <p>Over hoist detector is activated.</p> <p>Hook raising operation stops.</p>  |
| <p>When the hook was lowered excessively</p>   | <ul style="list-style-type: none"> <li>• Alarm buzzer sounds continuously</li> </ul>  | <p>Tow block is activated.</p> <p>Hook raising operation stops.</p> <p>Rope warning is activated.</p> <p>Hook lowering operation stops.</p>  |
| <p>When the machine tilts for 3 degrees or more during crane operation</p>   | <ul style="list-style-type: none"> <li>• Alarm buzzer sounds continuously</li> </ul>  | <p>Crane inclination alarm device is activated</p>   |

**[4] CRANE STOWING OPERATION**

| Standard Operation Sequence, Machine Status  | Display and Warning   | Activation of Safety Devices   |
|--|---|--|
| <p>Operate the machine to take the boom stowing posture.</p> <ul style="list-style-type: none"> <li>• Fully retract the boom</li> <li>• Boom horizontal stowing position</li> <li>• Boom slew and stow position</li> </ul> | <ul style="list-style-type: none"> <li>• Boom stowing lamp on display panel ON</li> </ul> | <p>Outrigger interlock device</p> <ul style="list-style-type: none"> <li>• If the boom stowing lamp (green) does not light up, all the outrigger operations stop.</li> </ul> |



**[5] OUTRIGGER STOWING OPERATION**

| Standard Operation Sequence, Machine Status   | Display and Warning   | Activation of Safety Devices  |
|---|---|---|
| Stow the outriggers.<br>1. Set and stow the outriggers.<br>• Work selector switch “OUTRIGGER”<br>• Outrigger setting switch “ON”  | • Setting lamps (red) on display panel flash<br>[Outrigger un-set warning lamp flashes]<br>[Working status lamp (red) ON]   | Crane interlock device<br>• If any of the extension lamps and setting lamps (total of eight) goes off, all the crane operations stop. |
| 2. Extend and stow the outriggers.<br>• Outrigger extension switch “ON”<br>• Rotate (Stow) the outrigger rotary and secure at the specified position with position pin.<br>• Stop the engine. | • Extension lamps (red) on display panel flash<br>[Outrigger un-set warning lamp flashes]<br>[Working status lamp (red) ON] |   |
| When the machine tilts for 3 degrees or more during outrigger stowing operation   | •Warning buzzer sounds continuously   | Crane inclination alarm device is activated   |

**[6] MACHINE TRAVELING OPERATION**

| Standard Operation Sequence, Machine Status  | Display and Warning                 | Activation of Safety Devices                |
|--|-------------------------------------|---|
| Travel the machine.<br>• Traveling lock lever at “TRAVEL” position<br>• Start the engine.<br>• Operate the traveling levers. |                                     |   |
| When the machine tilts for 15 degrees or more during traveling operation   | •Warning buzzer sounds continuously | Crane inclination alarm device is activated |



## 2.14 OUTRIGGER SETTING OPERATION

### **⚠ WARNING**

- **GROUND FOR SETTING OUTRIGGERS**

Always set the outriggers to the level, safe and solid ground.

Performing the crane operation without setting the outriggers can contribute to the overturning of the machine.

- **OUTRIGGER SAFETY DEVICE**

Always set the emergency stop cancel switch to the "OFF" (auto) position when operating the outriggers.

Do not operate the outriggers with the emergency stop cancel switch at the "ON" (cancel) position.

Set the emergency stop cancel switch to the "ON" (cancel) position only when performing the inspection and maintenance.

- **EXTENDING AND SETTING THE OUTRIGGERS**

- Keep people away from the machine when setting the outriggers.

Staying around the machine may cause serious accidents such as getting caught between an outrigger and the machine main unit.

- Always monitor the level to level the machine when setting the outriggers.

When the machine tilts for "3 degrees" or more, the overturning alarm buzzer sounds.

- Set the outriggers so that the rubber tracks are about 2 inches (50 mm) above the ground.

After setting the outriggers, verify that all the four outriggers are securely set.

- The outriggers of this machine can be set flexibly according to the terrain. However, if the outriggers cannot be set in the "outrigger maximum extension" state, perform the crane operation with the values given in the "Rated total load chart with outrigger medium extension" and "Rated total load chart with outrigger minimum extension" in the rated total load chart.

- When Extending and setting the outriggers, always maintain the outrigger rotary at the extension position, and insert the position pin to the end. Do not set the outriggers with the outrigger rotary stowed.

- There are four outriggers. Be careful not to mistake 8 outrigger switches for the others. Check the numbers shown on the "operation plate" at the switch section and the location of the "number plate" affixed to the outriggers. Wrong operation can lead to serious accidents.

- When operating two outrigger setting switches at the same time, choose two front switches (outrigger (1) and (4)) or two rear switches (outrigger (2) and (3)). Operating two left or right switches at the same time will suddenly raise two outriggers on one side, causing overturning of the machine.

- When raising the machine, operate the four outrigger switches to raise them gradually and uniformly. Suddenly raising two outriggers on one side will overturn the machine.

- Reduce the engine speed to low speed when operating the outrigger switches.

At the high engine speed, the outriggers operate suddenly, leading to serious accidents such as overturning of the machine.

- Do not extend the outriggers with the outriggers set. Doing so applies unreasonable force on the outriggers, resulting in the outrigger breakage.

- Always set the traveling lock lever to the "LOCK" position when operating the outriggers.

### **CAUTION**

- Always keep the boom at the "fully retracted, lowest position and slew and store position" when operating the outriggers. The outriggers cannot be operated if the boom is not stowed completely. (Verify that the boom stowing lamp (green) on the outrigger display is ON.)

- After extending the outriggers, verify that the outriggers are securely set.

If all the outriggers are not securely set, the crane operations will not be enabled. (Verify that all of the extension lamps and setting lamps (green) of the outrigger display are lit.)

## ⚠ WARNING

### • SELECTING LOCATION TO SET OUTRIGGERS

- When setting the outriggers on the structural objects such as construction site or concrete floor, verify in advance that the surface where the outriggers will be set has sufficient strength.

Insufficient strength in the setting surface will result in overturning or fall of machine due to collapse of the setting surface.

- Setting the outriggers on the soft ground as given below will cause the tray of the outriggers to sink in the ground, leading to the overturning of the machine.

- Road surface with low-cost pavement (low-cost asphalt or thin concrete)

- Surface with paving stones.

- Area reclaimed after excavation work

- Landfill

- Road shoulders or area close to hole such as excavation work

- Deteriorated pavement surface

- Areas where under the pavement surface is hollow due to water erosion and the top soil appears to be hard but soft in the ground.

- Slope

### • PROTECTING GROUND

- Place a sole plate of sufficient size with sufficient strength under the tray of all the outriggers on the soft ground to protect the ground.

- If you have to set the outriggers near the road shoulder by necessity, take secure action to prevent the collapse of the road shoulder.

- When working on the slope, level the tray of all the outriggers and the ground under the rubber tracks before setting the outriggers.

Setting the outriggers with the tilted ground surface without leveling the ground surface will cause the outriggers to slip or overturn, causing serious accidents.

- If the ground is not protected or if the outriggers may sink even after protecting the ground, do not perform the crane operations.

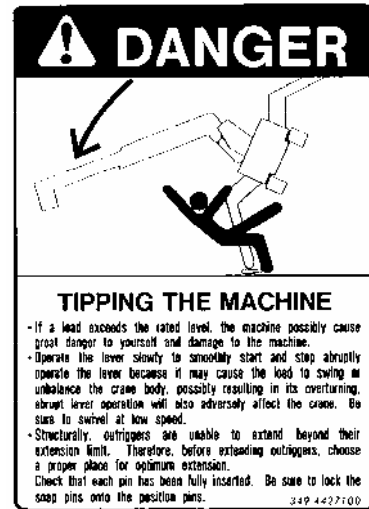

|  |  |  |
|--|--|--|
| <p>Use of stable sole plate</p> <p style="text-align: right; font-size: small;">XAM21110</p> | <p>Surface with low-cost pavement</p> <p style="text-align: right; font-size: small;">XAM21120</p> | <p>Surface with paving stones</p> <p style="text-align: right; font-size: small;">XAM21130</p> |
| <p>Landfill, etc.</p> <p style="text-align: right; font-size: small;">XAM21140</p>           | <p>Leveling ground of slope</p> <p style="text-align: right; font-size: small;">XAM05870</p>       |  |

### 2.14.1 NAME OF OUTRIGGER COMPONENTS

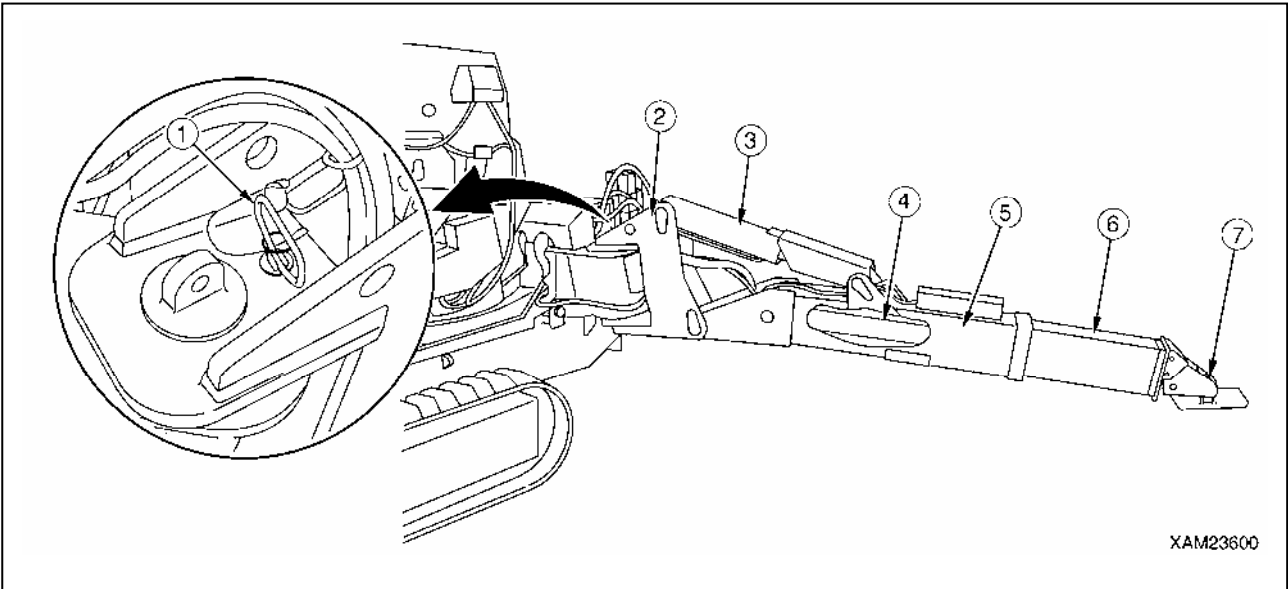

- |                                  |                              |
|----------------------------------|------------------------------|
| (1) Position pin                 | (5) Outer box                |
| (2) Rotary                       | (6) Inner box                |
| (3) Outrigger setting cylinder   | (7) Outrigger adapter (Tray) |
| (4) Outrigger extension cylinder |                              |

### 2.14.2 OUTRIGGER SETTING OPERATION

#### [1] TASKS TO BE PERFORMED UPON ENGINE STOP

There are four outriggers installed to the machine.  
 Although the setting method is described for just one outrigger (outrigger (4)), set the other three outriggers in the same way.

1. Operate the traveling lock lever (8) to the "LOCK" position.

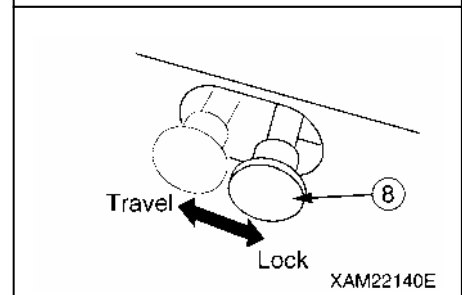
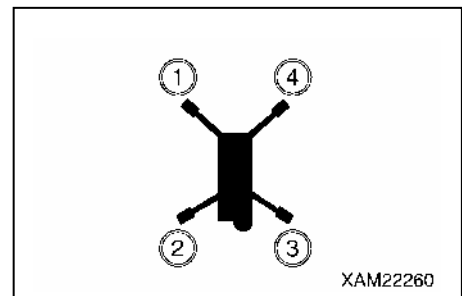

2. Turn the starter switch to the "ON" position.

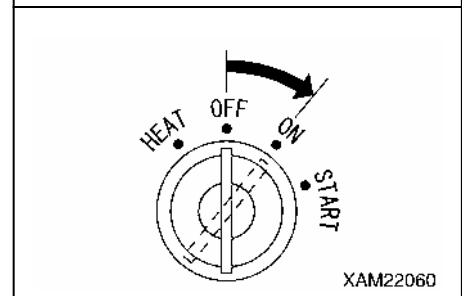

3. Operate the work selector switch on the outrigger operation panel to the "OUTRIGGER" position.

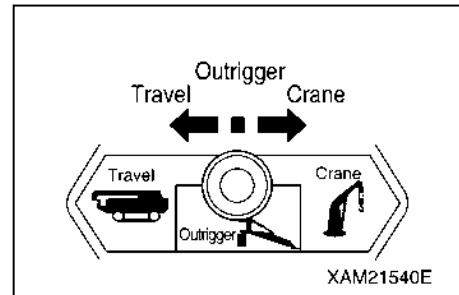

4. Verify that the boom stowing lamp (1) (green) on the outrigger display is ON.

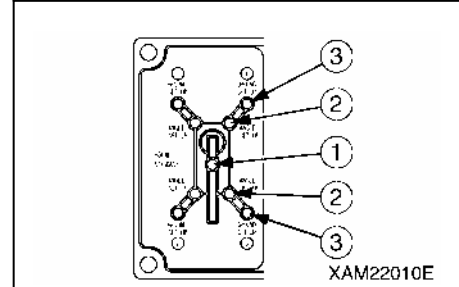

5. Pull the position pin (1) out of the rotary (2) and rotate the rotary outward.

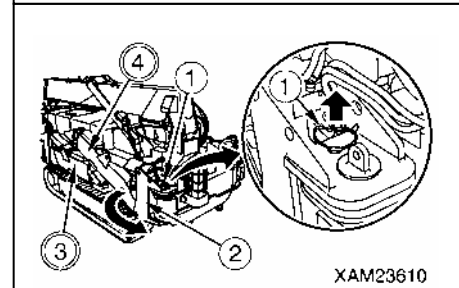

6. Insert the position pin (1) to the end at the position where the pin holes are aligned after rotating the rotary (2) outward.

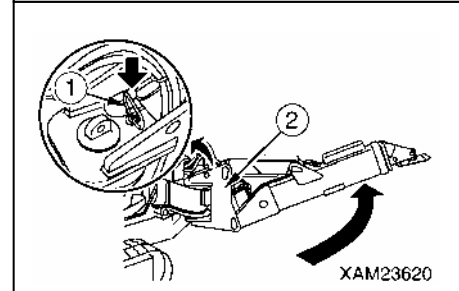

**NOTES**

The position pin (1) has a wire to prevent the loss of the pin.

7. Perform the same preparatory task to the other three outriggers.

**NOTES**

After completing the preparatory task, verify that the position pin (1) is securely inserted.

8. Verify that the four outrigger extension lamps (2) (green) on the outrigger display are ON.

**NOTES**

The boom stowing lamp (1) and four outrigger extension lamps (2) on the outrigger display are ON.

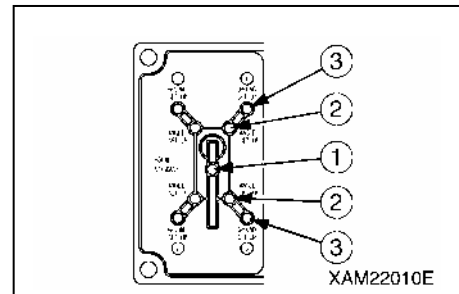

## [2] TASKS TO BE PERFORMED AFTER STARTING ENGINE

### ⚠ WARNING

The overturning alarm buzzer sounds if the machine tilts for “3 degrees” or more when setting the outriggers. Operate the outrigger switches and adjust the machine to be leveled in which state the alarm buzzer will not sound.

1. See “Operation 2.2 Starting Engine” and start the engine.
2. Release your foot from the acceleration pedal (6) and change the engine speed to idling.

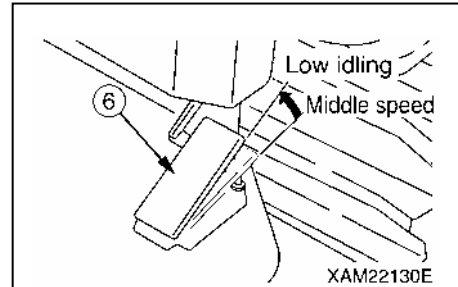

3. Check the number on the operation plate at the switches on the outrigger operation panel to determine which outrigger to be operated.

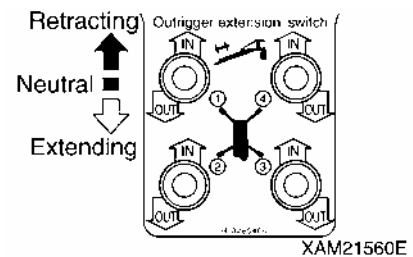

4. Push down an outrigger extension switch or two of them at the same time to the “OUT” side.

When the outrigger extension cylinder extends and the inner box extends to the desired position, set the switch to the “NEUTRAL” position.

Operate the remaining switches in the same way and extend the inner box of the four outriggers to the desired position. Set the switch to the “NEUTRAL” position.

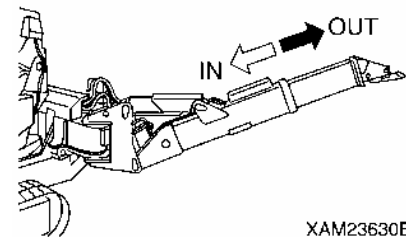

5. Push down an outrigger setting switch or two of them at the same time to the “OUT” (downward) side.

When the setting cylinder extends and the tray is set, set the switch to the “NEUTRAL” position.

Operate the remaining switches in the same way and set the tray of all the four outriggers. Set the switch to the “NEUTRAL” position.

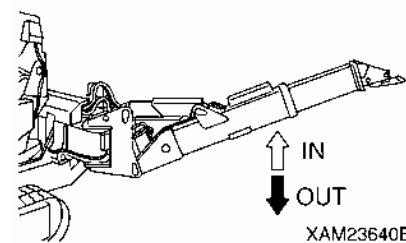
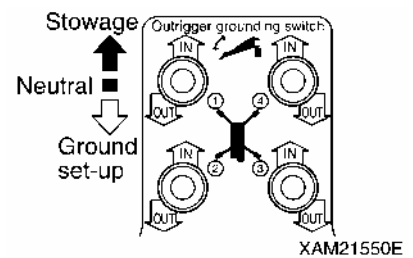

## ⚠ WARNING

When operating two outrigger setting switches at the same time, choose two front switches (outrigger (1) and (4)) or two rear switches (outrigger (2) and (3)). Operating two left or right switches at the same time will suddenly raise two outriggers on one side, causing overturning of the machine.

6. After all the trays were set, push down an outrigger setting switch or two of them at the same time to the "OUT" (downward) position.

When the setting cylinder extends and the machine is slightly raised, set the switch to the "NEUTRAL" position.

Operate the remaining switches in the same way so that the four outriggers are raised to the same height. Set the switch to the "NEUTRAL" position.

Repeat this operation to gradually raise the machine until the rubber tracks will be at the height of about 50 mm above the ground.

7. When the machine was raised to about 50 mm above the ground, operate the outrigger operation switches while checking the position of the bubble in the level to adjust the machine to be leveled.

8. After setting the outriggers, operate all the outrigger operation switches to the "NEUTRAL" position.

9. Verify that the four outrigger setting lamps (3) (green) on the outrigger display are ON.

### NOTES

On the outrigger display, all the boom stowing lamp (1), four outrigger extension lamps (2), and four outrigger setting lamps (3) are illuminated in green.

### CAUTION

If any of the setting lamps (3) is flashing in red, remove the cover (7) of the outrigger tray (6) and check if there is any foreign object pinched in the bending section.

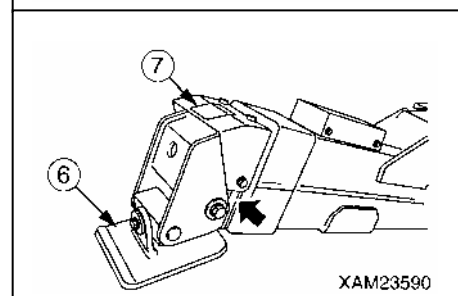
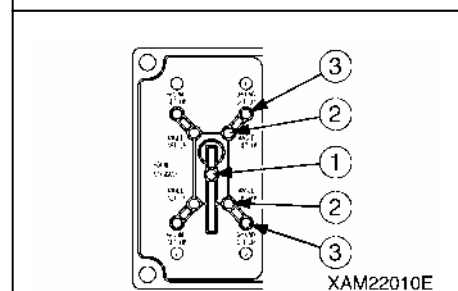
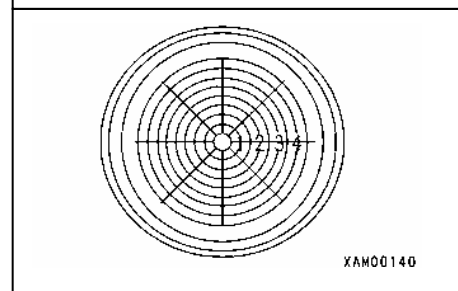
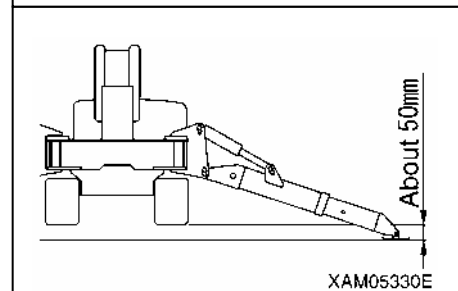
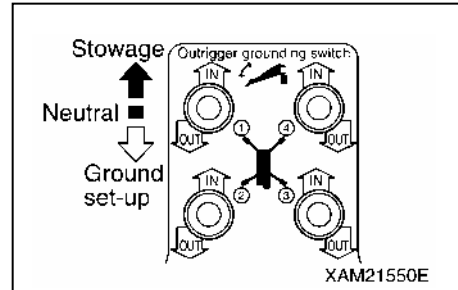



## 2.15 CAUTIONS BEFORE CRANE OPERATION

### ⚠ WARNING

Not observing these cautions before operation may result in serious accidents.

- Verify that the emergency stop cancel switch, boom stowing switch, and hook stowing switch are at the “OFF” position. If these switches are at “ON” position, the operations will not stop.

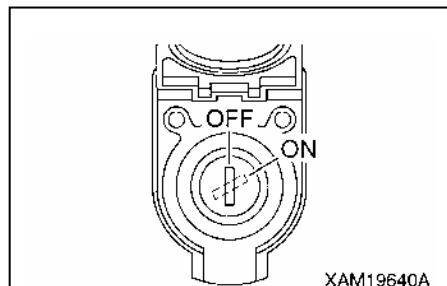

- Over hoisting the hook block will activate the alarm buzzer of the over hoist detector and the operation stops. When the alarm buzzer sounds, release your hand immediately from the winch lever (3) to the “NEUTRAL” position to stop raising the hook. Then, operate the winch lever (3) to “DOWN” (push forward) side to lower the hook block.

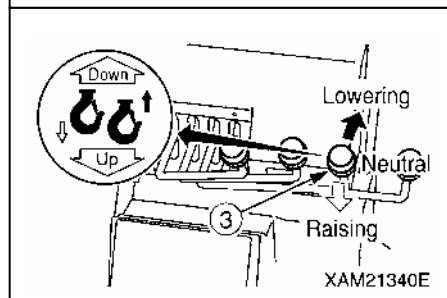

- Extending the boom will hoist the hook block, activating the alarm buzzer of the over hoist detector and the operation stops. When the alarm buzzer sounds, release your hand immediately from the boom telescoping lever (2) to the “NEUTRAL” position to stop extending the boom. Then, operate the boom telescoping lever (2) to “RETRACT” (pull toward you) side to retract the boom.

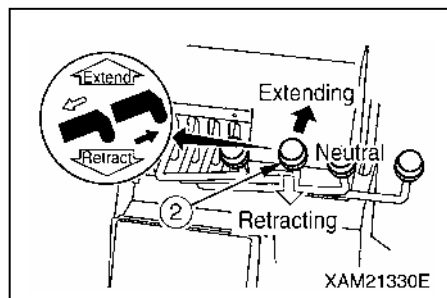

- Use the horn switch to honk the horn to notify the people around of the danger during the crane operation.

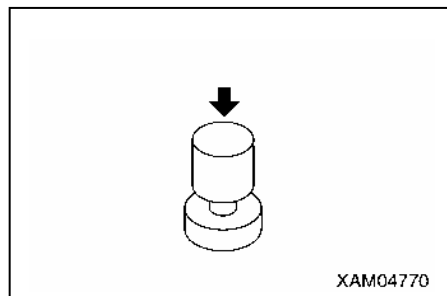

- Verify that all the outriggers are extended and set. If any of the four outrigger extension lamps (2) or four outrigger setting lamps (3) is flashing in red, the crane cannot be operated.

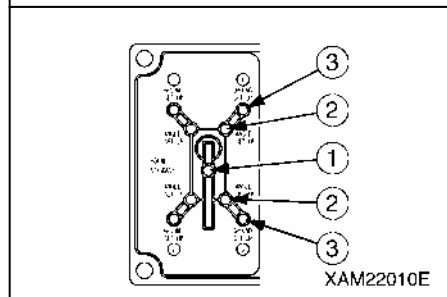

## 2.16 OPERATIONS BEFORE CRANE OPERATIONS

### CAUTION

- Verify that all the lamps on the outrigger display are illuminated in green before performing the crane operation. The crane cannot be operated if any of the four outrigger extension lamps and four outrigger setting lamps is flashing in red.
- Set the traveling lock lever (8) to the "LOCK" position when operating the operation levers of the crane system and outrigger switches.
- When loosening the stowing of the hook block, be careful not to topple the entire hook block sideways on the ground by loosening the wire rope too much. This will cause irregular winding on the winch drum.
- When loosening the stowing of the hook block, the hook block may swing and interfere with the peripheral devices, resulting breakage of the devices. Pay sufficient attention around the hook block.

Perform the following operations before crane operation.

1. Operate the traveling lock lever (8) to the "LOCK" position.

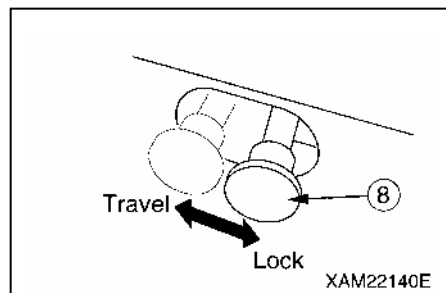

2. Operate the work selector switch on the outrigger operation panel to the "CRANE" position.

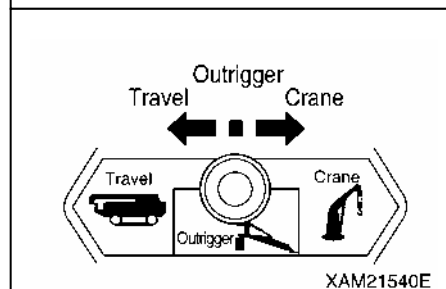

3. Operate the winch lever (3) to the "DOWN" (push forward) side to loosen the hook block from the stowing position.

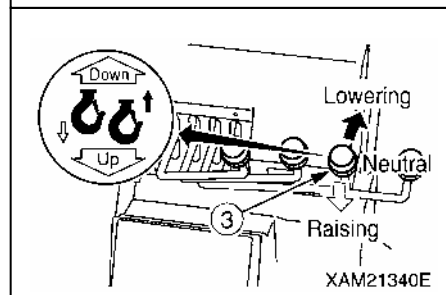

## 2.17 CRANE OPERATION POSTURE

Take the crane operation posture by following the procedure below when switching to the operation from the state described in “2.16 Operations before Crane Operations” in the Operation.

1. Operate the winch lever (3) to the “DOWN” (push forward) side and lower the hook but not to let the hook block touch the ground.

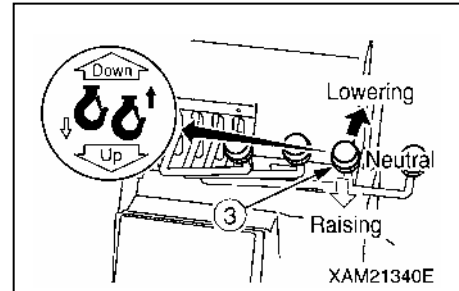

2. Operate the boom derricking lever (4) to the “RAISE” (pull toward you) side and raise the boom to the angle where the hook block is not over hoisted and not touching the ground.

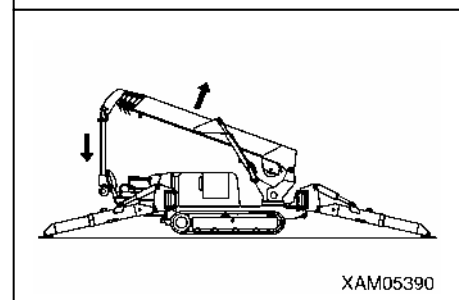
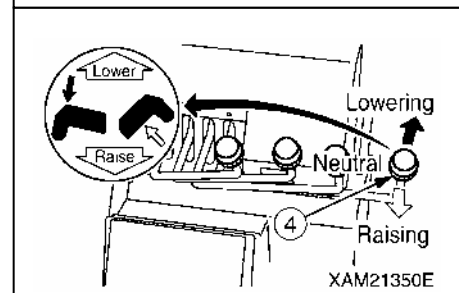

## 2.18 HOOK RAISING/LOWERING OPERATION

### ⚠ WARNING

- With the boom deflection, the hoisted load slightly shifts forward. Notify the workers around such as slinging operators.
- If the hook block was hoisted too much, the over hoisting will be detected. The alarm buzzer sounds and the audible message saying “Hook over hoisted” will be heard. When the alarm buzzer and audible voice were heard, operate the winch lever immediately to the “NEUTRAL” position and stop raising the hook.
- When lowering the hook for long distance for underground works, be sure to leave more than three turns of the wire rope on the winch drum.

### CAUTION

Do not let the hook block touch the ground.  
The winch drum will wind irregularly, damaging the wire rope.

Operate the winch lever (3) as follows;

- Lower: Push the lever forward “DOWN”.
- Neutral: Release your hand from the lever.

The lever will return to the “NEUTRAL” position and the raising/lowering of the hook block stops.

- Raise: Pull the lever to the “UP” side toward you.

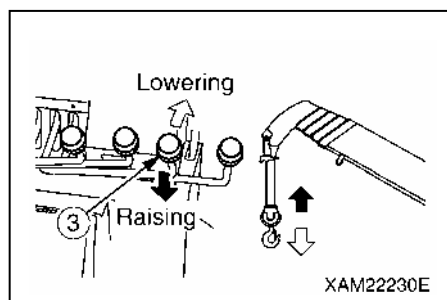

### NOTES

Adjust the winch raising/lowering speed with the winch lever and stroke of the acceleration pedal.

## 2.19 BOOM DERRICKING OPERATION

### ⚠ WARNING

- Operate the boom derricking lever as slowly as possible. Sudden lever operation especially while hoisting a load will cause the load to swing, giving a great impact to the machine, and thus may break the crane or overturn the machine.
- Lowering the boom increases the working radius and the rated total load that can be hoisted decreases. Be extremely careful so that the load weight will not be overloaded with the boom most lowered when working by derricking the boom.

Operate the boom derricking lever (4) as follows.

- Lower: Push the lever forward to the “LOWER” side.
- Neutral: Release your hand from the lever.

The lever goes back to the “NEUTRAL” position and the boom derricking stops.

- Raise: Pull the lever toward you to the “RAISE” side.

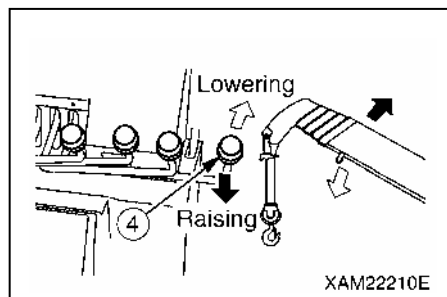

### NOTES

Adjust the boom derricking speed with the boom derricking lever and the stroke of the acceleration pedal.

## 2.20 BOOM TELESCOPING OPERATION

### **⚠ WARNING**

- Operate the boom telescoping lever as slowly as possible. Sudden lever operation especially while hoisting a load will cause the load to swing, giving a great impact to the machine, and thus may break the crane or overturn the machine.
  - Do not pull the load horizontally or pull in the load by telescoping the boom.
  - Extending the boom increases the working radius and the rated total load that can be hoisted decreases. Be extremely careful so that the load weight will not be overloaded with the boom most extended when working by telescoping the boom.
  - When the boom is extended, the hook block is raised.
- If the alarm buzzer of the over hoist detector and the audible message of “Hook Over Hoisted” are heard during the boom extending operation, return the boom telescoping lever immediately to the “NEUTRAL” position and stop the boom extending operation.

### **CAUTION**

- The hook block is raised or lowered while telescoping the boom. Perform the winch operation at the same time to adjust the hook block height.
- When the boom is maintained extended for a long time, the boom slightly retracts due to the temperature change in the hydraulic oil. In this case, extend the boom as needed.

Perform the boom telescoping lever (2) as follows.

- Extend: Push the lever forward to the “EXTEND” side.
- Neutral: Release your hand from the lever.  
The lever returns to the “NEUTRAL” position and the boom telescoping stops.
- Retract: Pull the lever toward you to the “RETRACT” side.

### **NOTES**

Adjust the boom telescoping speed with the boom telescoping lever and the stroke of the acceleration pedal.

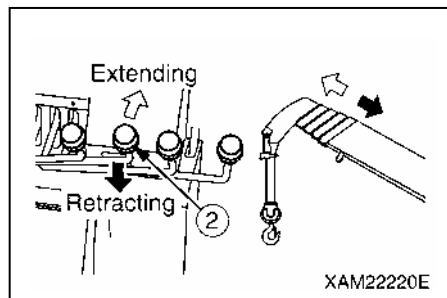

## 2.21 SLEWING OPERATION

### ⚠ WARNING

- Check the safety around and honk the horn before slewing.
- Operate the slewing lever as slowly as possible. Start smoothly, slew at low speed, and stop gently. Sudden lever operation especially while hoisting a load will cause the load to swing, causing the loss of stability in the machine, and thus may break the crane or overturn the machine.
- Even if the outriggers are set normally, some directions have lower stability when slewed for 360 degrees. Be extremely careful when slewing while hoisting a load.
- Depending on how outriggers are extended, the hoisted load may hit an outrigger during the slewing operation, breaking the crane or overturning the machine. Be careful not to let the hoisted load hit an outrigger.

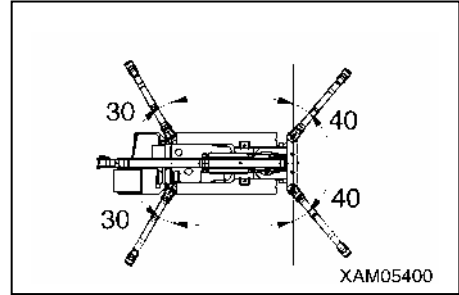

Operate the slewing lever (1) as follows.

- Slew counter clockwise: Push the lever forward to the “LEFT” side.  
The lever returns to the “NEUTRAL” position and the slewing stops.
- Neutral: Release your hand from the lever.  
The lever returns to the “NEUTRAL” position and the slewing stops.
- Slew clockwise: Pull the lever toward you to the “RIGHT” side.

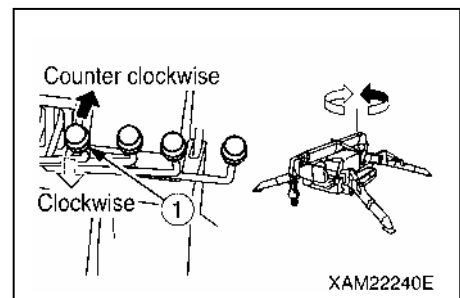

### NOTES

Adjust the crane slewing speed with the slewing lever and the stroke of the acceleration pedal.

## 2.22 ACCELERATION OPERATION

### ⚠ WARNING

Accelerating the operation speed of the crane units more than is necessary is dangerous.

### CAUTION

Decrease the speed in the beginning or near the end of an operation. Change the speed to low speed or high speed according to the load.

Operate the acceleration pedal (6) as follows.

- Low idling: Release your foot from the pedal.  
The engine speed decreases and the operation speed of the crane units slows down.
- Full speed: Fully step on the pedal.  
The engine speed increases, and the operation speed of the crane units accelerates.

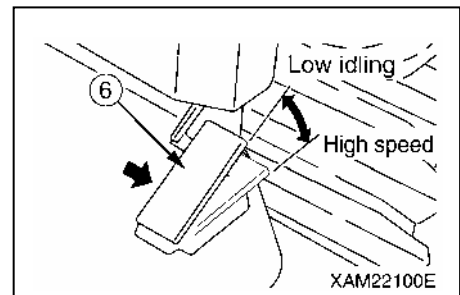

### NOTES

Step on the pedal to the position of the engine speed necessary for the task.

## 2.23 CRANE STOWING OPERATION

### ⚠ CAUTION

The hook stowing switch cancels the auto stop function of the over hoist detector. Operate the winch lever carefully not to let the hook block hit the boom when stowing the hook block.

### CAUTION

- Stop the swing of the hook block before stowing the hook block.
- When stowing the hook block, do not topple the entire hook block sideways on the ground by loosening the wire rope too much. This will cause the irregular winding on the winch drum.
- The boom “retracting” operation will lower the hook block. The hook block also lowers with the boom “lowering” operation. Raise the hook at the same time so that the hook block will not touch the ground or interfere with the machine.
- Stow the boom securely into the stowing position. After stowing the boom, verify that the boom stowing lamp on the outrigger display lights up in green. If the boom stowing lamp does not light up, the outriggers cannot be stowed. If the boom stowing lamp does not light up, lower the boom to the maximum or slew the boom to verify that the boom stowing lamp lights up.

1. Operate the boom telescoping lever (2) to the “RETRACT” (pull toward you) side to fully retract the boom.

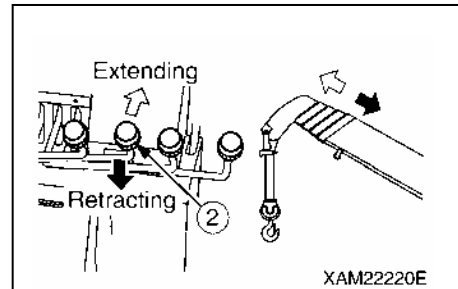

2. Operate the slewing lever (1) to the “LEFT” or “RIGHT” side so that the boom slews to the center of the machine.

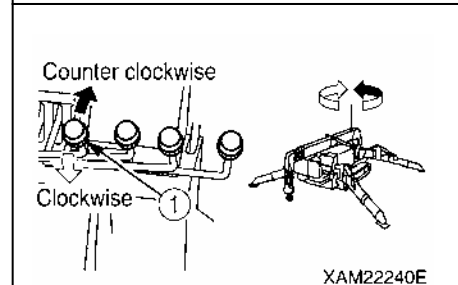

3. Operate the boom derricking lever (4) to the “LOWER” (push forward) side and lower the boom until it automatically stops.

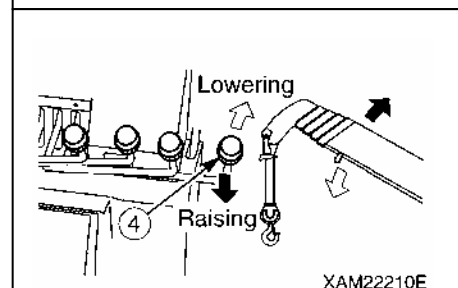

4. With the boom stowing switch knocked to the “ON” position, operate the boom derricking lever (4) again to the “LOWER” (push forward) side to stow the boom.

### NOTES

When the boom stowing switch is at the “ON” position, the pilot lamp at the switch section lights up.

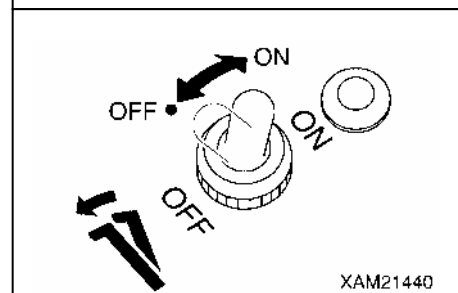

5. Operate the winch lever (3) to the “UP” (pull toward you) side and winch until the hook block automatically stops (over hoist).

**NOTES**

Hoisting the hook block too much will result in the detection of over hoist. Then the alarm buzzer and audible message of “Hook Over Hoist” are heard and the hook raising operation automatically stops.

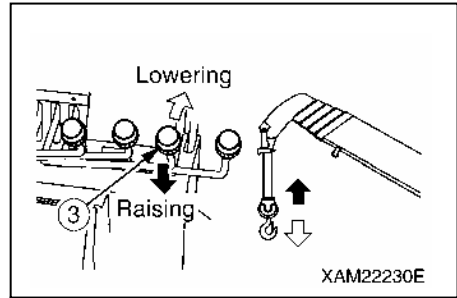

6. With the hook stowing switch at the “ON” position, operate the winch lever (3) to the “UP” (pull toward you) side again and slowly raise the hook block (4) to stow the block at the bottom of the boom end.

**NOTES**

Operating the hook stowing switch to the “ON” position turns on the pilot lamp at the switch section.

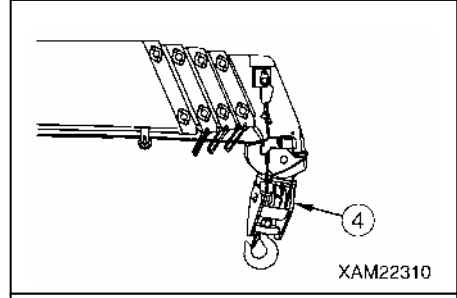
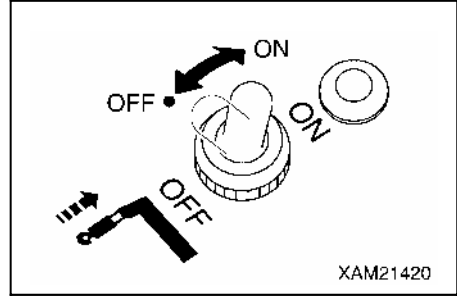

7. Verify that the boom stowing lamp (1) (green) on the outrigger display lights up.

**NOTES**

If the boom stowing lamp (1) (green) on the outrigger display does not light up, repeat the boom lowering operation to the lowest position and slewing operation.

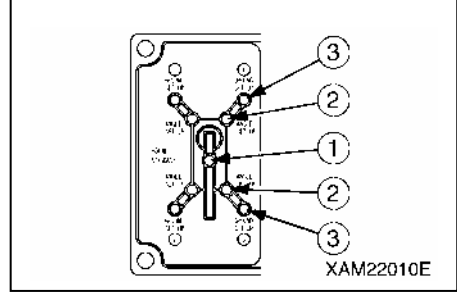



## 2.24 OUTRIGGER STOWING OPERATION

### ⚠ WARNING

- Do not let people approach toward the machine when stowing the outriggers. Staying around the machine may result in serious accidents such as getting caught between an outrigger and the main unit of the machine.
- Verify that there is nothing under the rubber tracks when stowing the outriggers. If there is any object under the rubber tracks, the machine may overturn and serious accidents may occur when stowing the outriggers.
- Stop the engine for operation except for extending/setting the outrigger cylinders. The third person touching an outrigger may result in sudden movement of the outrigger cylinder, which may lead to serious accidents.
- When the position pin is removed, the outrigger loses the support and rotates. Always hold the outrigger with one hand when removing the position pin.
- Do not put your hands or fingers around the gaps of movable areas when stowing the outriggers. Your hands or fingers may get caught, and it may lead to serious accidents.
- Insert the position pin to the end when stowing the outriggers.
- There are four outriggers. Be careful not to mistake 8 outrigger switches for the others. Check the numbers shown on the “operation plate” at the switch section and the location of the “number plate” affixed to the outriggers. Wrong operation can lead to serious accidents.
- When operating two outrigger setting switches at the same time, choose two front switches (outrigger (1) and (4)) or two rear switches (outrigger (2) and (3)). Operating two left or right switches at the same time will suddenly raise two outriggers on one side, causing overturning of the machine.
- Reduce the engine speed to low speed when operating the outrigger switches. At the high engine speed, the outriggers operate suddenly, leading to serious accidents such as overturning of the machine.
- When lowering the raised machine, operate the eight outrigger switches so that the four outriggers are lowered little by little. Suddenly retracting two outriggers just on the right side or left side will cause instability in the machine and it can overturn the machine.
- Do not perform the outrigger extending operation after they are set on the ground. Doing so applies unreasonable force on the outriggers, resulting in the outrigger breakage.
- Always set the traveling lock lever to the “LOCK” position when operating the outriggers.

### CAUTION

- Always keep the boom at the “lowest position and slew and stow position” when operating the outriggers. The outriggers cannot be operated if the boom is not stowed completely. (Verify that the boom stowing lamp (green) on the outrigger display is ON.)
- Operate the work selector switch on the outrigger operation panel to the “OUTRIGGER” position.

### [1] TASKS TO BE PERFORMED AFTER STARTING ENGINE

Although the stowing method is described for just one outrigger (outrigger (4)), stow the other three outriggers in the same way.

1. Operate the traveling lock lever (8) to the “LOCK” position.

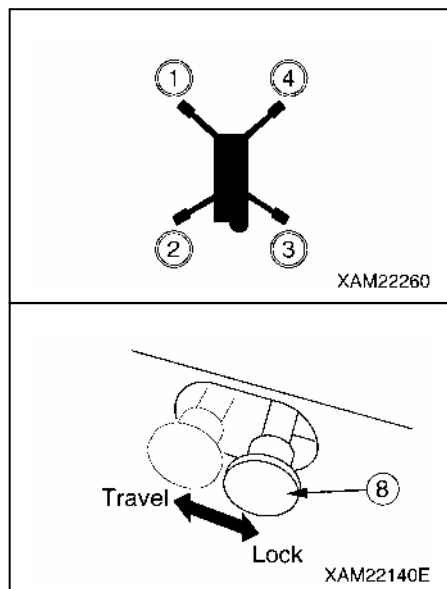

2. See "Operation 2.2 Starting Engine" and start the engine.
3. Release your foot from the acceleration pedal (6) and change the engine speed to idling.
4. Operate the work selector switch on the outrigger operation panel to the "OUTRIGGER" position.
5. Verify that the boom stowing lamp (1) (green) on the outrigger display is illuminated.

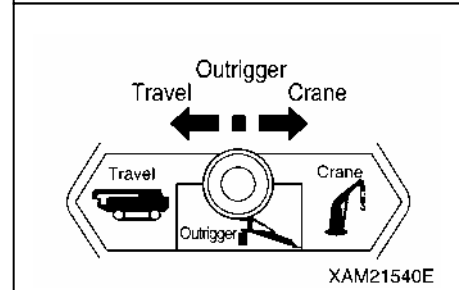
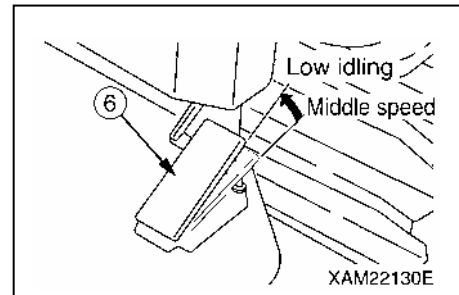

5. Verify that the boom stowing lamp (1) (green) on the outrigger display is illuminated.

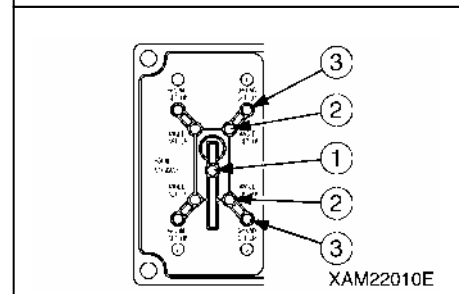

## ⚠ WARNING

**When operating two outrigger setting switches at the same time, choose two front switches (outrigger (1) and (4)) or two rear switches (outrigger (2) and (3)). Operating two left or right switches at the same time will suddenly raise two outriggers on one side, causing overturning of the machine.**

6. Check the number on the operation plate at the switch section on the outrigger operation panel to determine which outrigger to be operated.
7. Push down an outrigger setting switch or two of them at the same time to the "ON" (upward) side.  
When the outrigger setting cylinder retracts and the machine starts to go down, return the switch to the "NEUTRAL" position. Operate the remaining switches in the same way and lower all the four outriggers to the same height. Return the switch to the "NEUTRAL" position.  
Repeat this operation to gradually lower the machine until the rubber tracks go down completely on the ground.

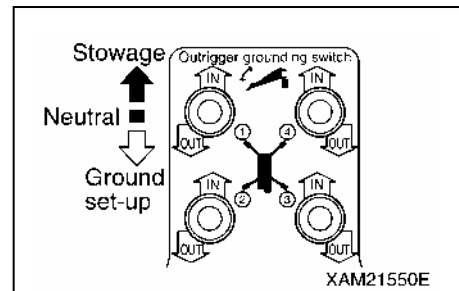

8. When the left and right rubber tracks are completely set on the ground, push down again an outrigger setting switch or two of them at the same time to the "IN" (upward) side.  
When the setting cylinder completely retracts and the top box goes up to the upper limit, release your finger from the outrigger setting switch.

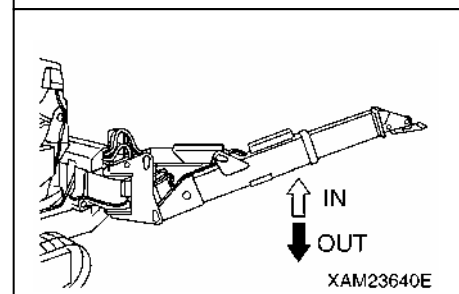

9. Verify that the four outrigger setting lamps (3) on the outrigger display are flashing in red.

**NOTES**

On the outrigger display, the boom stowing lamp (1) (green) is illuminated and four outrigger extension lamps (2) and four outrigger setting lamps (3) are flashing in red.

10 Push down an outrigger extension switch or two of them at the same time to the “IN” (upward) side.

When the extension cylinder fully retracts and the inner box is at its shortest, return the switch to the “NEUTRAL” position.

Operate the remaining switches in the same way and make the inner box of the four outriggers to their shortest. Return the switch to the “NEUTRAL” position.

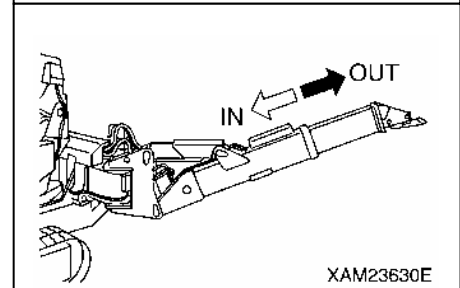
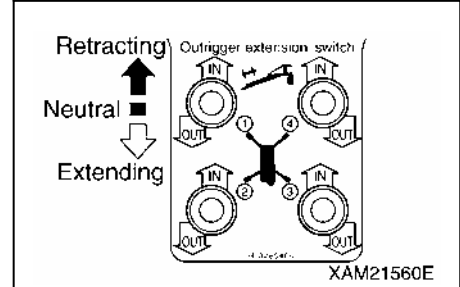
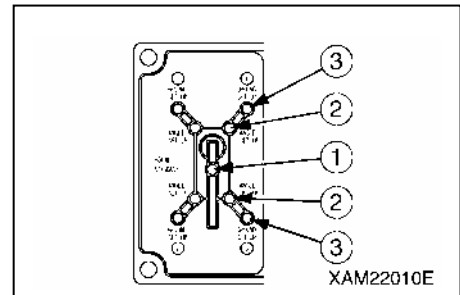

11. Turn the starter switch to the “OFF” position.

The engine stops.

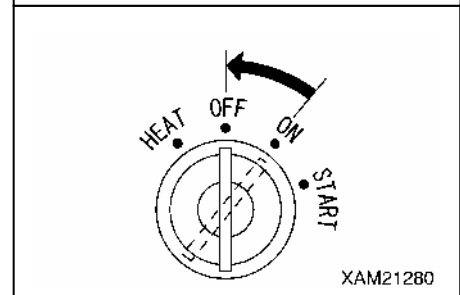

## [2] TASKS TO BE PERFORMED UPON ENGINE STOP

1. Pull the position pin (1) out of the rotary (2) and rotate the rotary inward.

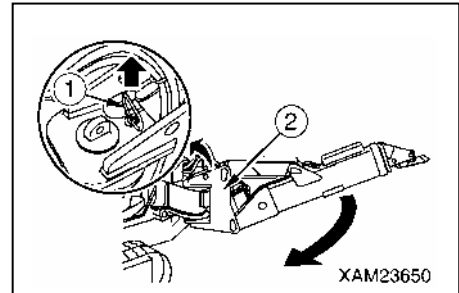

2. Insert the position pin (1) to the end at the position where the pin holes are aligned after rotating the rotary (2) inward.

### NOTES

The position pin (1) has a wire to prevent the loss of the pin.

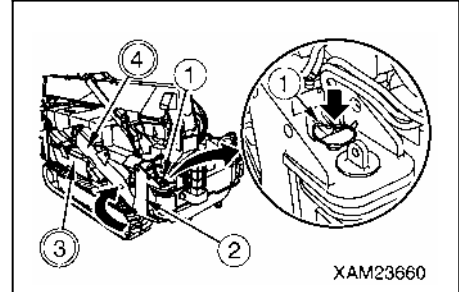

3. Stow the other three outriggers in the same way.

### NOTES

After stowing the outriggers, verify that the position pin (1) is securely inserted.

4. Verify that the four outrigger extension lamps (2) on the outrigger display went off.

### NOTES

On the outrigger display, the boom stowing lamp (1) (green) is illuminated and four outrigger extension lamps (2) and four outrigger setting lamps (3) are flashing in red.

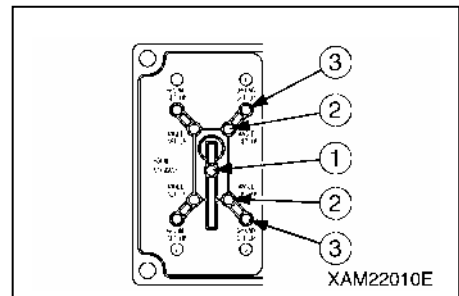

## 2.25 DOS AND DON'TS DURING CRANE OPERATIONS

### **⚠ WARNING**

- Always set the outriggers on the leveled solid ground when performing the crane operations.
- Never perform traveling hoist or the crane operations without setting the outriggers.  
The machine will be unstable and overturn, leading to serious accidents.
- See the cautions given in the Safety besides the dos and don'ts in this section.

#### **[1] DON'T OPERATIONS WITH SLEWING FORCE**

Drawing in or lifting the load with slewing operation is prohibited.

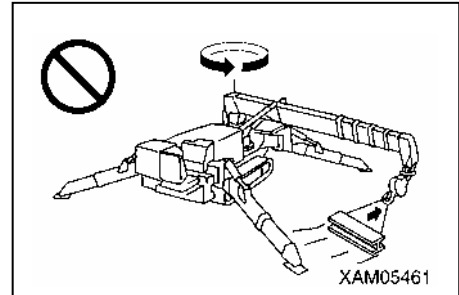

#### **[2] DON'T OPERATIONS WITH DERRICKING FORCE**

Drawing in or lifting the load with boom derricking operation is prohibited.

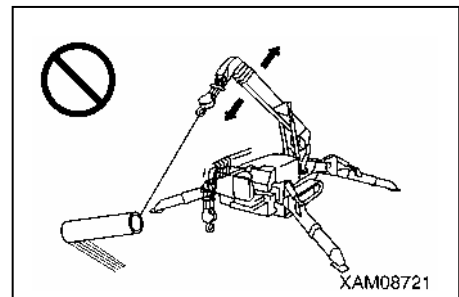

#### **[3] DON'T PULL SIDWARD, DRAW IN, AND HOIST DIAGONALLY**

Pulling sideward, drawing in, or hoisting diagonally applies unreasonable force on the machine. It not only damages the machine body, but also is dangerous. Never operate in these ways. The hook must come right above the center of gravity of the load hoisted.

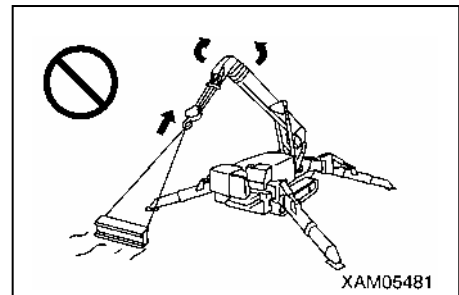

#### **[4] DON'T OPERATE VIOLENTLY DURING OPERATION**

Do not operate the lever suddenly.

Especially, the "slewing", "boom lowering", and "hook lowering" must be operated at low speed.

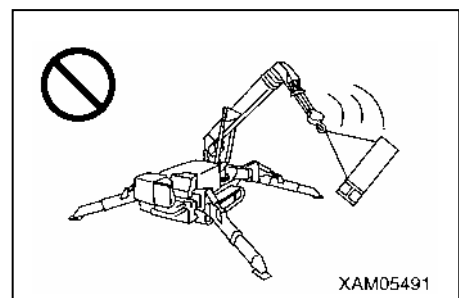

**[5] DON'T ACCESS INTO WORKING RADIUS**

Do not let people access into the working radius such as permitting an operator to go under the hoisted load.

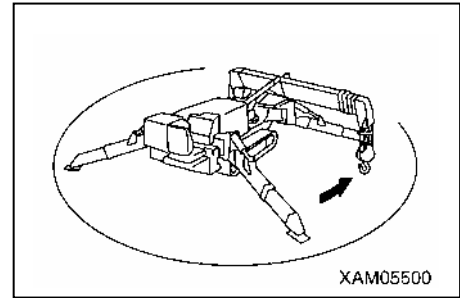

**[6] DON'T USE FOR OTHER THAN MAIN APPLICATIONS**

Do not move people up/down with the crane.

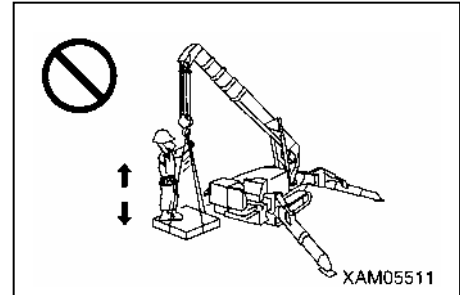

**[7] DON'T PERFORM UNREASONABLE OPERATIONS**

Operations requiring more than the machine performance can cause accidents.

Particularly, the crane operations must be carried out according to the rated total load chart.

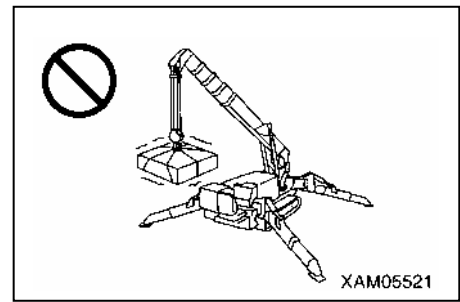

**[8] DON'T WIND WIRE BY FORCE**

Be careful not to hook the wire rope over a tree or steel beam while working.

If it gets stuck with something, do not force to wind the wire. Untangle and then wind the wire.

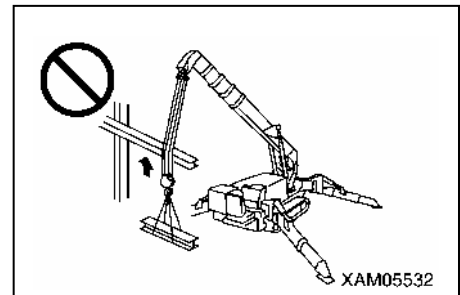

**[9] DON'T OPERATE DURING TRAVELING HOIST**

The load may swing or the machine may overturn during the traveling hoist.

Do not perform slewing operation or crane operations.

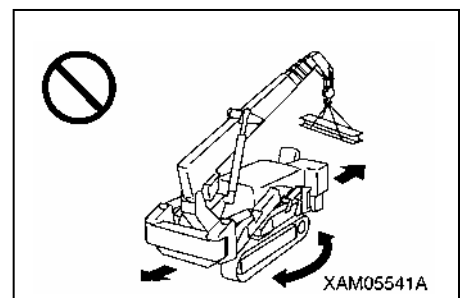

## **3. HANDLING RUBBER TRACKS**

### **3.1 GOOD USE**

While the rubber tracks demonstrate many advantages thanks to its performance characteristic to the material, it has a weak point in strength.

Therefore, we would like you to sufficiently understand the characteristics of the rubber tracks and to respect don'ts operations and observe the cautions on handling so that the life of the rubber tracks can be extended and its advantages exercised.

Be sure to read "3.3 Dos and Don'ts with Rubber Tracks" and "3.4 Cautions in Using Rubber Tracks" in the Operation before using the machine.

### **3.2 WARRANTY**

Verification of proper tension of the rubber tracks, maintenance of rubber tracks, and damage caused by the fault of customers such as not respecting don'ts operation or not observing cautions in working, for example, "worked at the site where there were objects that may tear the rubber blocks, such as steel plates, U-shaped gutters, corners of bricks, corners of sheer broken stones and rocks, reinforcing steels, and iron scraps", are not covered by warranty.

### 3.3 DOS AND DON'TS

The following operations are prohibited.

- Working and slewing on the ground with broken stones, hard rock ground with great irregularity, reinforcing steels, iron scraps, and near the edge of the steel plates will damage the rubber tracks.

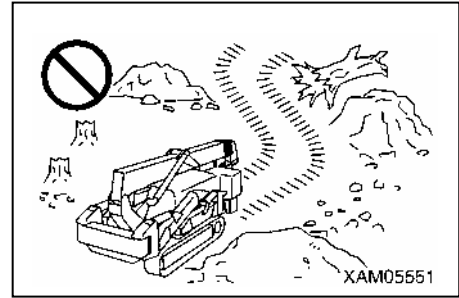

- At the location where there are great amount of large and small boulder stones such as river beds, the stones will go under the machine, tending to damage the rubber tracks or the rubber tracks tend to come off.

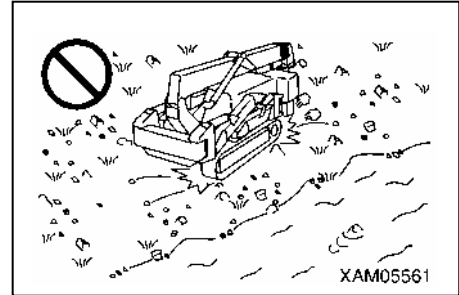

- Keep the oil and chemical solvents away from the rubber tracks. If these materials come in contact with the rubber tracks, wipe it off immediately. Do not TRAVEL over the road surface where the oil has built up.

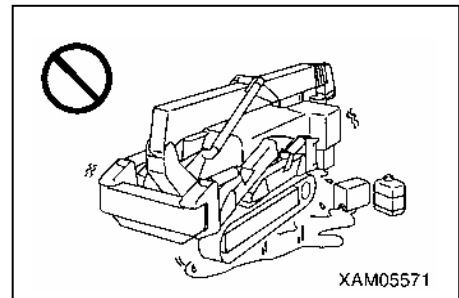

- Do not go in the area where it is hot such as with open fire, the steel plate left under the burning sun, or newly poured asphalt.

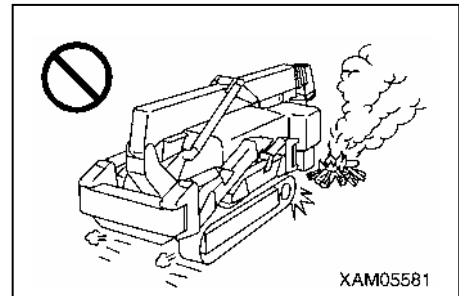

- Keep the rubber tracks indoor where there is no direct sunlight or rain when storing them for long time (three months or more).



### 3.4 CAUTIONS IN USING RUBBER TRACKS

#### **⚠ WARNING**

Not observing these cautions in using rubber tracks will cause serious accidents or damage on rubber tracks.

Keep the followings in mind during the operation.

- Avoid making spin turns on the concrete surface.  
Sudden steering cause early wear or defect on the rubber tracks.  
Avoid making sudden steering whenever possible.

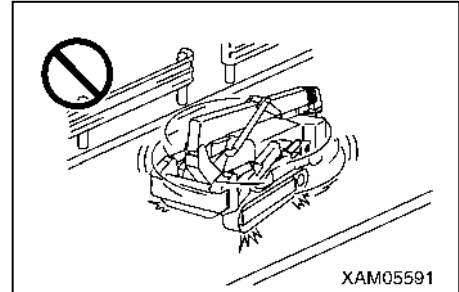

- Do not operate the machine in a way that the edge of the rubber tracks is pressed against the concrete and walls.

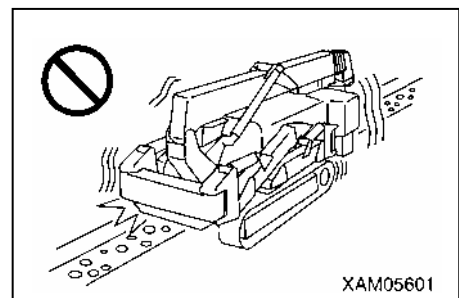

- Avoid steering at the location with a great step.  
Make the machine perpendicular to the step when going over it.  
Going over the step diagonally may result in the rubber tracks coming off.

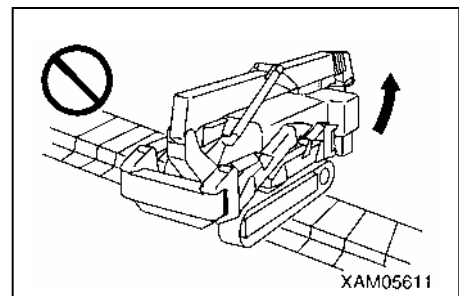

- The rubber tracks slip very easily on a wet steep plate or snowed and frozen surface. Be especially careful not to slip when operating on the slope.

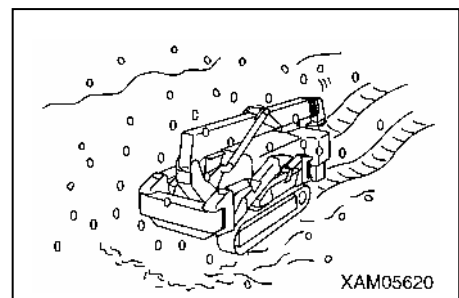

- Avoid using the rubber tracks whenever possible depending on the material to be worked on.

If you used the rubber tracks on these materials by necessity, wash thoroughly with water after the use.

- Avoid the operation on the material crushed and yielding oil (such as soy beans, corns, rape cake, etc.)
- Handling salt, ammonium sulfate, potassium chloride, or concentrated superphosphate corrodes the bonding at the cored bar section.

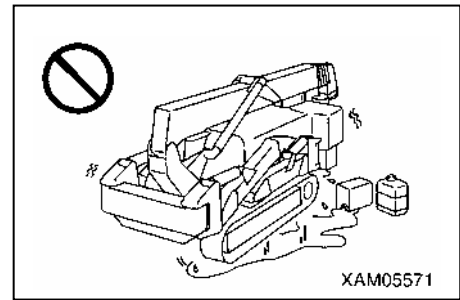

- Salt corrodes the bonding at the cored bar section. Avoid using the machine on the beach whenever possible.

- The operation in the very cold land changes the material of the rubber tracks, shortening its life.  
Use the rubber tracks in the range of -25°C to + 55°C, due to the physical property of the rubber.

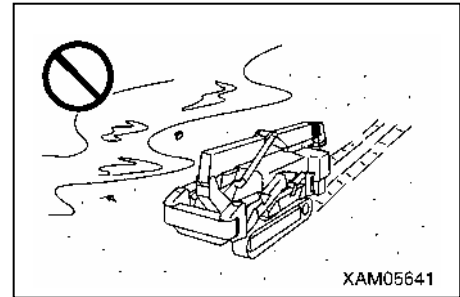

- When handling food such as salt, sugar, wheat, and soybeans, some pieces of wire or rubber may be mixed in the food if there is any deep scratch on the rubber tracks.  
Use the rubber tracks after repairing the cracked rubber.

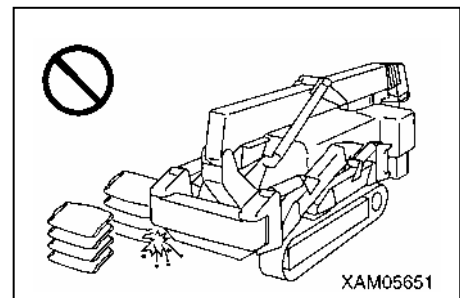

- Always use the rubber tracks at appropriate tension to prevent the rubber track from coming off.  
Loose tension will allow the rubber tracks to come off.

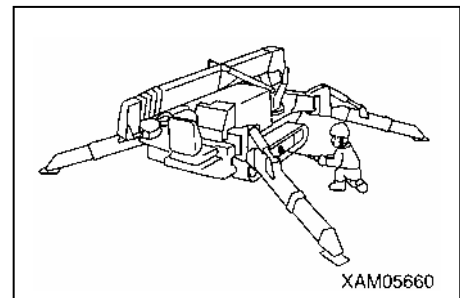

## 4. HANDLING WIRE ROPES

### 4.1 BENCHMARK FOR REPLACING WIRE ROPES

#### CAUTION

- The benchmark for replacing wire ropes is common to all the wire ropes for winching, telescoping the boom, and slinging.
- Measure the wire rope diameter at the section where the rope repeatedly passes through the sieve. Measure from three directions and average the value.
- Do not use the old wire ropes even if they had not been used.
- See “Maintenance 8.5 [2] Replacement Winch Wire Ropes” for how to replace the wire rope.
- Contact us or our sales service agency for replacing/repairing the wire ropes.

#### [1] WIRE ROPE NOMINAL DIMENSION

- Wire rope for winching : IWRC 6 x Ws (26) 0/0  $\phi$  8 x 73 m
- No. 5 wire rope for extending boom: IWRC 6 x Fi (29) 0/0  $\phi$  8 x 5.825 m
- No. 5 wire rope for retracting boom: IWRC 6 x Fi (29) 0/0  $\phi$  6 x 10.885 m

#### [2] BENCHMARK FOR REPLACING WIRE ROPES

The wire rope fatigues as time goes by.

Change the wire ropes when they show the following signs.

- In one twist (6 crests), 10 % or more of the wires (excluding the filler wires) are broken.

#### NOTES

Change winching/boom telescoping wire rope when 13 or more wires are broken.

- The diameter of the wire rope is worn for 7 % or more of the nominal diameter.

#### NOTES

- Change the 8-mm diameter wire rope when it is reduced to 7.5 mm.
- Change the 6-mm diameter wire rope when it is reduced to 5.6 mm.

- The rope is twisted and has some kinks.
- The rope shows remarkable deformation or corrosion.
- The rope shows some abnormality at the terminals.

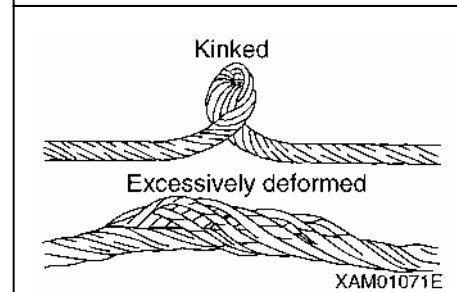
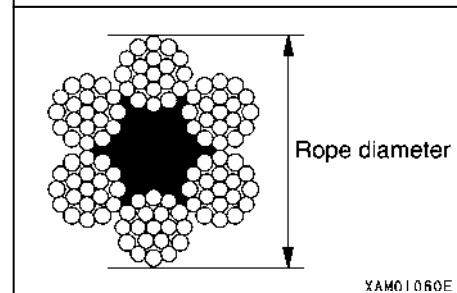
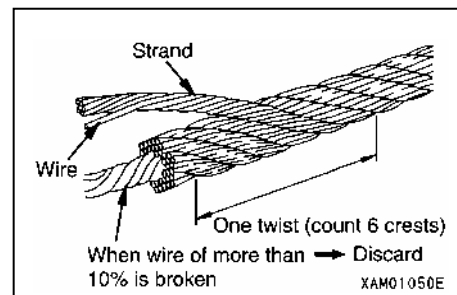

## 4.2 What TO DO WITH TWISTED WINCH WIRE ROPE

### ⚠ WARNING

Be sure to wear a pair of thick leather working gloves when handling wire ropes.

### CAUTION

Change the hooking direction of the wire rope (inverse the hook block side and winch drum side) from time to time to extend the life of the wire rope.

When the wire rope gets twisted, straighten the twist with the following procedure.

1. With the hook in normal condition, check the twisting direction and how many times the rope is twisted.
2. Operate the winch lever to "DOWN" (push forward) side to lower the hook block onto the ground.  
If the hook cannot be lowered, operate the boom derricking lever to the "LOWER" (push forward) side to lower the boom or operate the boom telescoping lever to the "RETRACT" (pull toward you) side to retract the boom to lower the boom.
3. Turn the starter switch to the "OFF" position to stop the engine.
4. Remove the wedge socket pin securing bolt (1) to remove the wedge socket (2).
5. Force to twist the end of the wire for "n" (number of wire falls) times of the number hook is twisted for in the opposite direction from the direction the hook block is twisted to and which you checked in the step 1 (opposite direction from the one the wire rope tries to go back to naturally when you release your hand from the wedge socket) and install the wire rope.
6. Start the engine and operate the boom derricking lever to the "RAISE" (pull toward you) side to increase the boom angle to its maximum.
7. Operate the boom telescoping lever to the "EXTEND" (push forward) side to extend the boom to its maximum.
8. Operate the winch lever to repeat raising/lowering the hook block for several times.
9. Tidily spool up the wire rope into the winch drum with some tension applied to the rope.
10. Repeat the above procedure until the hook is no more twisted.

If the wire rope is still twisted after performing the procedure above, change with a new wire rope.

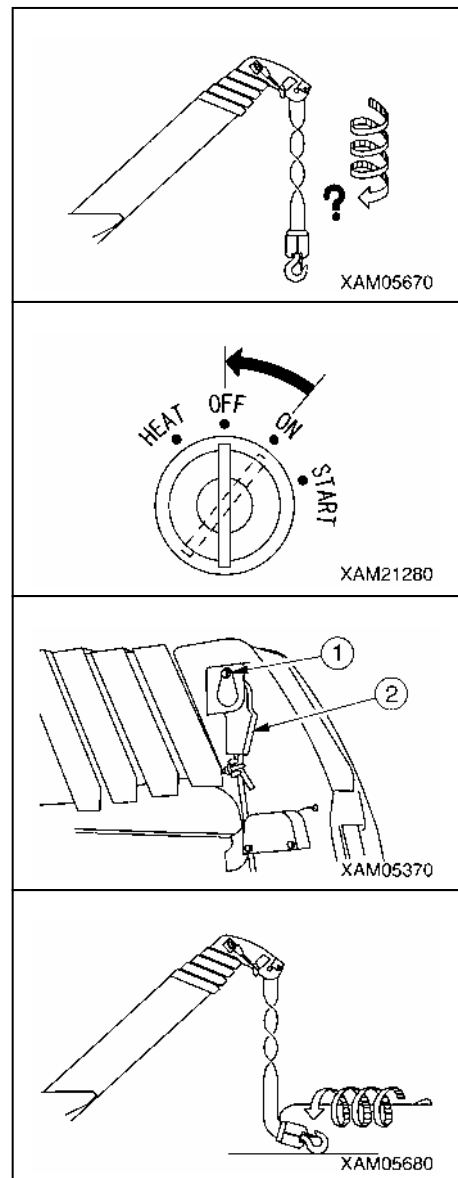

## 5. TRANSPORTATION

Observe the related laws and regulations and transport the machine safely.

### 5.1 LOADING/UNLOADING

#### WARNING

- See "Specifications 1.1 Specification List " in the Dimension for the dimensions and mass of the machine.
- Select and use the ramp boards that satisfy the following conditions.
  - Has the length that when placed, the angle from the track is 15 degrees or less.
  - Has the width no narrower than the rubber tracks.
  - Has the thickness and strength that can fully withstand the mass of the machine.
- Be sure to place the ramp boards perpendicular to the truck box.  
Also, match the center of the each of the rubber tracks with the center of corresponding ramp board. Misguided ramp boards and unmatched rubber crawlers may cause the machine to slip out of the ramp boards and cause serious accidents.
- Use ramp boards with slope of 15 degrees or less. The space between boards shall be set to be appropriate to the center of the rubber tracks.
- Always put the machine in the "traveling posture" when loading/unloading the machine. See "Operation 2.5 Machine Traveling Posture" for traveling posture.
- Always load the machine by moving backward. Moving forward involves overturning hazard. The operator must be on the back side of the truck.
- Always unload the machine by moving forward. Moving backward involves overturning hazard. The operator must be on the back side of the truck.
- Loading/Unloading the machine involves danger. Be extremely careful.
- Select flat and solid ground for loading/unloading the machine. Keep sufficient distance from the shoulders.
- Remove dirt around the crawlers to prevent side slip of the machine on the ramp boards. Remove any materials on the loading ramps such as ice, grease, and oil.
- Never change direction on the ramp boards. Go down from the ramp board, and then change the direction.

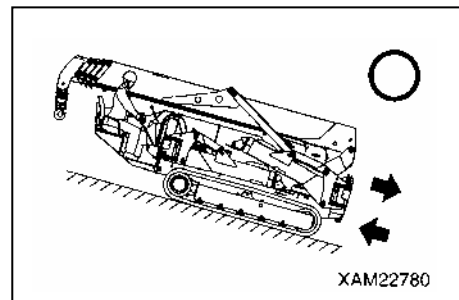

Always put the machine in the "traveling posture" when loading/unloading the machine. Always use ramp boards or forwarding blocks when loading/unloading the machine and use the following procedure.

1. Brake the trailer securely. Place wheel blocks to the wheels of the trailer to secure the trailer.
2. Secure the ramp boards in a way that the center of the trailer and the machine agree.

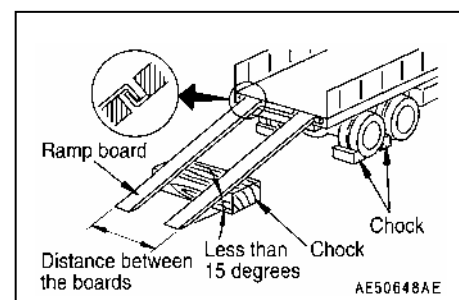

#### NOTES

Verify that the two ramp boards are at the same height.

3. Operate the acceleration pedal and keep the engine at low speed.
4. TRAVEL slowly toward the ramp boards, and load/unload the machine in a way that the boom does not hit the trailer. Move backward to load the machine, and forward to unload the machine.
5. Do not operate any other lever than traveling levers on the ramp boards.
6. Load the machine properly to the desired position on the trailer.

## 5.2 HOISTING MACHINE

### ⚠ WARNING

- The hoisting attachments such as wire rope and shackle used in hoisting shall be sufficiently strong for the weight of this machine.
- When hoisting the machine, always put the machine in the “traveling posture” and securely insert the four position pins into the rotary of the outriggers.  
As for the center of gravity of the machine, the machine posture is determined to be “traveling posture”.  
See “Operation 2.5 Machine Traveling Posture” for traveling posture.
- Hoisting the machine for long time will cause the boom derricking cylinder to extend, shifting the center of gravity and thus, the machine losing the balance.
- When transporting the machine by using the crane, use the transportation equipment shown in the figure on the right and transport safely.
- Do not hoist the machine in the posture other than those described in the following procedure. The machine may lose its balance.

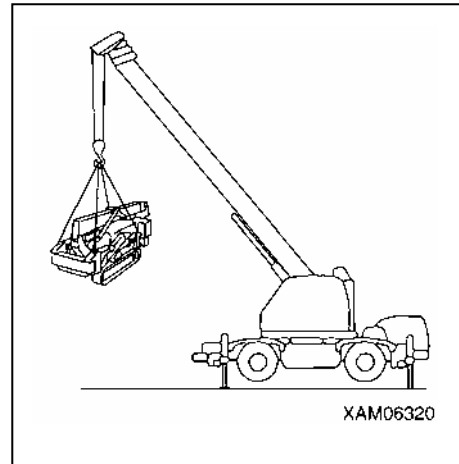

### CAUTION

- When the local laws and regulations are applicable, the person who uses the crane to perform hoisting operation must be qualified to do it. If not, the operator must be well trained and skilled.
- See the Dimension or the nameplate attached to the machine for the weight of the machine.
- The dimensions are for standard specifications. The hoisting method varies depending on the attachments and options mounted. In that case, contact us or our sales service agency.

MC-305C-2 Total weight  
**3900kg**  
103-4551000

Load per single line of  
4 parts hanging  
**975kg**  
103-4551500

Hoist the machine on the solid and flat ground using the following procedure.

1. See “Operation 2.5 Machine Traveling Posture” and put the machine in the “traveling posture”.
2. Verify that the position pins (four) are securely inserted in the rotary joint of the outrigger.

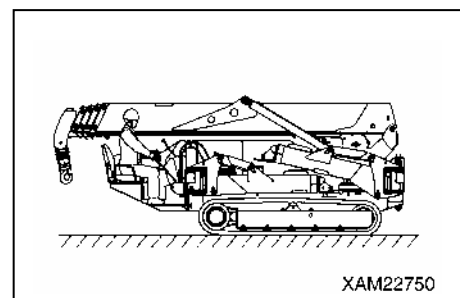

3. Install a shackle (1) to the holes (4 locations) on the outrigger rotaries and hang the hoisting attachments (2) over the hook (3).
4. As soon as the machine leaves the ground, stop and wait until the machine is stabilized. Then slowly hoist the machine.
5. Check the changes in the posture due to the leakage from the hydraulic circuit on the head side of the derricking cylinder (4) when the machine is hoisted.

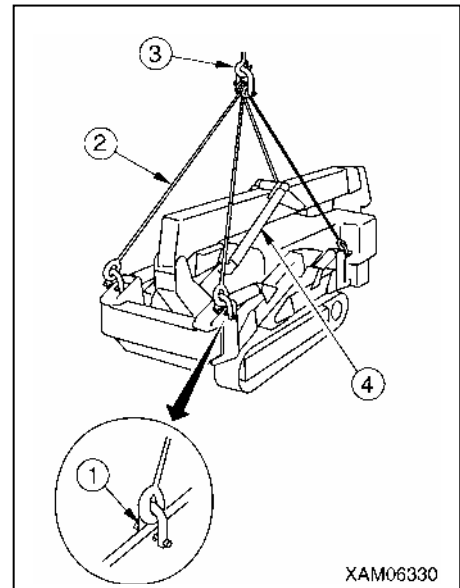

### NOTES

- ★ Recommended hoisting attachments
  - Wire ropes (two in front): 12.5 diameter x length of 2150 mm (breaking force of 7.5 t or more), with eye lock and nominal 12A thimble at one end
  - Wire ropes (two in back): 12.5 diameter x length of 1650 mm (breaking force of 7.5 t or more), with eye lock and nominal 12A thimble at one end
  - Shackle: BC or SC, nominal 14

## 5.3 CAUTIONS IN LOADING MACHINE

### ⚠ WARNING

Select flat and solid ground for loading/unloading the machine. Keep sufficient distance from the shoulders.

Load the machine to the specified position on the trailer and secure the machine with the following procedure.

1. Stop the engine and remove the key of the starter switch.
2. Provide a square timber in front and back of the rubber tracks to prevent the machine from moving during transportation. Secure the machine with chain or wire rope. Secure it surely, especially not to let it slip to the side.

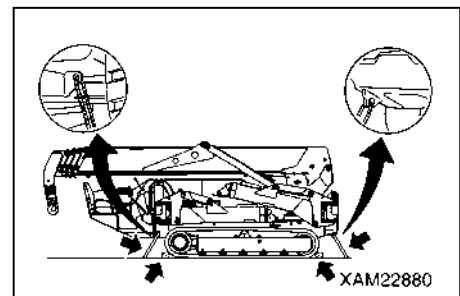

## 5.4 CAUTIONS DURING TRANSPORTATION

### ⚠ WARNING

Take road width, height, and weight into consideration in determining the transportation route.

If there are applicable local laws and regulations, observe these laws and regulations for safe transportation.

If not, contact us or our sales service agency.

## 6. HANDLING IN COLD WEATHER

### 6.1 PREPARING FOR LOW TEMPERATURE

When the temperature goes down, the machine starts to have some difficulty in starting. Take the following actions.

#### [1] LUBRICATION

Change the oil to the one with low viscosity. See "Maintenance 5.1 Use of Lubricating Oil According to Temperature" for the specified viscosity.

#### [2] COOLING WATER

##### **⚠ WARNING**

**The antifreezing fluid is inflammable. Do not put the fluid close to fire and do not smoke while handling the fluid.  
Do not smoke when handling the antifreezing fluid.**

##### **CAUTION**

**Never use antifreezing fluid with methanol, ethanol, and propanol.**

See "Maintenance 8.10 Maintenance Every 1000 Hours [2] Cleaning Engine Cooling System" for the cooling water replacement period and mixing rate of antifreezing fluid.

#### [3] BATTERY

##### **⚠ WARNING**

- **The battery produces combustible gas and can be explosive. Do not put fire close to the battery.**
- **The battery fluid is a harmful substance. Keep it away from your eyes and skin. Should it come into contact with your eye or skin, wash the affected area with plenty of water and consult a physician immediately.**

The battery capacity drops when the temperature goes down.

In this condition, the battery fluid can freeze with low battery charging rate. Keep the charging rate as close to as 100 %. Keep the battery warm in order to start the engine next morning.

##### **NOTES**

Measure the specific gravity of the battery fluid and convert it into the charging rate using the chart below.

|                   |     | Fluid Temperature (°C) |      |      |      |
|-------------------|-----|------------------------|------|------|------|
|                   |     | 20                     | 0    | -10  | -20  |
| Charging Rate (%) | 100 | 1.28                   | 1.29 | 1.30 | 1.31 |
|                   | 90  | 1.26                   | 1.27 | 1.28 | 1.29 |
|                   | 80  | 1.24                   | 1.25 | 1.26 | 1.27 |
|                   | 75  | 1.23                   | 1.24 | 1.25 | 1.26 |



#### **[4] CAUTIONS AFTER COMPLETING THE OPERATION**

Observe the followings to prevent the machine from not being able to function the next morning because of deposits such as dirt and water and materials around the feet frozen.

- Remove the dirt and water on the machine.

Keep the hydraulic cylinder rod surface especially clean to prevent seal from being damaged with the dirt coming into the seal together with the water drops.

- Park the machine on the solid and dry ground.

If there is no such location to park, place a board on the ground to park the machine on the board.

This prevents the ground and around the feet of the machine from freezing and allows the machine to start moving next morning.

- Remove the drain plug to drain the water in the fuel system to prevent the water from freezing.
- The battery ability remarkably drops at low temperature.

Cover the battery or remove the battery from the machine and keep it at warm place to be installed next morning.

- If the electrolyte level is low, refill with distilled water next morning before starting the operation.  
Do not refill after the operation in order to prevent the water from freezing during the night.

#### **[5] AFTER THE COLD WEATHER IS GONE**

When the season changed and it started to get warm, take the following action.

- See "Maintenance 5.1 Use of Lubricating Oil According to Temperature" to change the oil in the system to the one with specified viscosity.

## 7. LONG-TERM STORAGE

### 7.1 BEFORE STORING MACHINE

#### CAUTION

The machine shall take the posture shown in the figure on the right during the long-term storage to protect the cylinder rod. See “Operation 2.5 Machine Traveling Posture” for traveling posture. (To prevent rust on the cylinder rod)

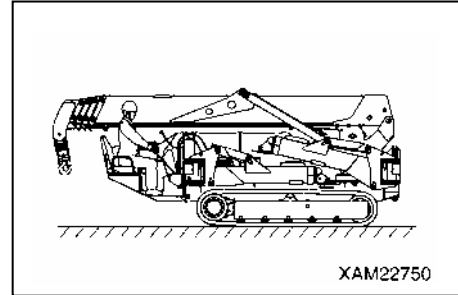

Store the machine as described below for long-term storage.

- Wash and clean each section of the machine and store indoor.  
If you absolutely have to leave it outdoor, select a flat location where the machine is not likely to be exposed to flood or other disasters and cover the machine.
- Refuel, grease, and change the oil without fail.
- Disconnect the negative terminal of the battery and cover, or dismount the battery from the machine for storage.
- If the temperature will go down to 0 degree or below, add antifreezing fluid. Ask us or our sales service agency for the mixing quantity of the antifreezing fluid.

### 7.2 DURING STORAGE

#### ⚠ WARNING

If you have to perform antirust operation indoor, open the window and entrance for better ventilation to prevent gas poisoning.

Be sure to operate the machine once a month during the storage to maintain the oil film at lubricating section. Charge the battery at the same time.

### 7.3 AFTER STORAGE

#### ⚠ WARNING

If you did not perform antirust operation monthly during the long-term storage, contact us or our sales service agency before using the machine.

Perform the followings before using the machine after the long-term storage.

- Refuel, grease, and change the oil without fail.
- Remove the cover over the battery (install the battery to the machine if dismantled for storage).  
Check the electrolyte level and specific gravity, and then connect the battery cable from the positive side.
- Remove the drain plug of the fuel tank, hydraulic oil tank, and engine oil pan to drain the water mixed in.
- Carefully perform the check before starting operation and warm-up operation.  
Carefully check the various parts of the machine.

## 8. HANDLING BATTERY

Observe the followings when handling the battery.

### **⚠ WARNING**

- Stop the engine and turn the main starter switch to the "OFF" position when hecking/handling the battery.
- Wipe off the dust accumulated on the top of the battery with moistened cloth.
- The battery produces hydrogen gas, involving the explosion hazard. Do not put fire such as cigarettes close to the battery or take any actions that can cause sparks.
- The battery fluid is diluted sulfuric acid, which corrodes clothes and skin. Should the battery fluid come into contact with your clothes or skin, wash the affected area immediately with plenty of water. Should it go into your eye, wash your eye immediately with clean water and consult a physician.
- Wear goggles and rubber gloves when handling the battery.
- Disconnect the ground side (normally (-) terminal) first to remove the battery, and conversely, connect the (+) terminal first to install the battery. Objects such as tools coming between (+) terminal and the machine body will cause sparks.
- Slackened battery terminals can cause sparks with poor contact, involving explosion hazard. Tighten securely when installing the terminals.
- Secure the battery when changing the battery to prevent the battery from being displaced. If it is not secured, the terminals will slacken, causing sparks.
- Verify the (+) terminal and (-) terminal when removing and installing the battery.

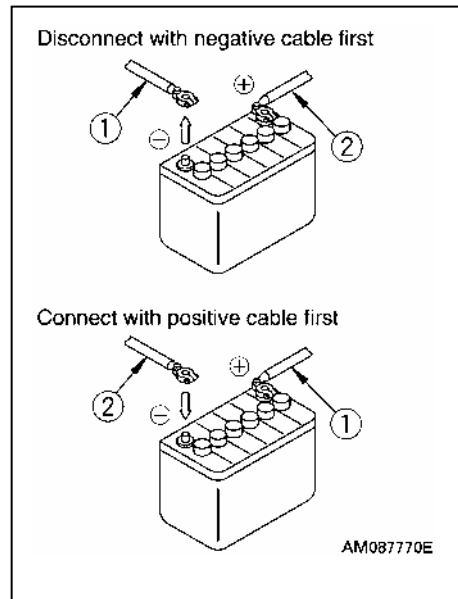

### 8.1 CAUTIONS IN HANDLING BATTERY

- Always try to keep the battery charged.  
The battery should not be charged in rush after being discharged. Measure the specific gravity of the battery fluid in advance and charge the battery as needed.  
Keeping the battery in the best condition lengthens the life of the battery.
- Check the electrolyte level earlier than regular check and maintenance schedule during the hot season.
- The battery ability remarkably drops during the cold season. Keep the charging rate as close to as 100 % and try to keep it warm for starting the operation next morning.

## 8.2 REMOVING/INSTALLING BATTERY

### CAUTION

Verify that the battery does not move after securing the battery. If it moves, secure it again.

#### [1] REMOVAL

1. See "Operation 2.14 Outrigger Setting Operation" to rotate the rotary of "outrigger (1)" and "outrigger (2)" outward.
2. Remove the four mounting bolts (4) and remove the battery cover (3).

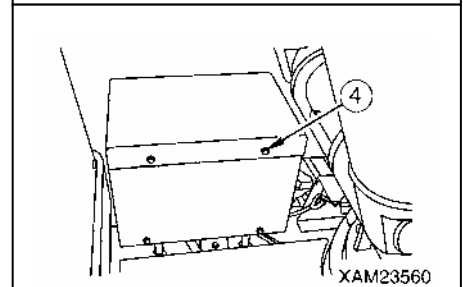
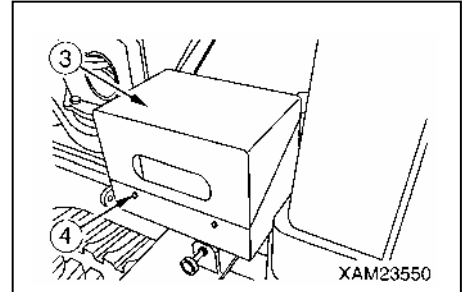

3. Disconnect the (-) terminal (5) on the ground side first and then the (+) terminal (6) to disconnect the battery cable.
4. Remove the wing nut (8), battery fixing brackets (7), and then remove the battery (9).

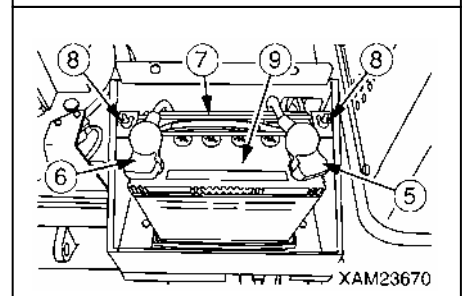

#### [2] INSTALLATION

- Reverse the removal procedure to install the battery.

### NOTES

Connect the (-) terminal (5) on the ground side last when connecting the battery.

## 8.3 CAUTIONS IN CHARGING BATTERY

When charging the battery mounted to the machine

- Abnormal voltage may be applied to the alternator, resulting in the breakage. Disconnect the battery terminal wires before charging the battery.
- Remove all the fluid plugs to release the gas generated.
- Stop charging when the battery was overheated (fluid temperature exceeded 45 °C).
- Stop charging promptly once the charging is completed.

Charging even after the charging is completed will;

- (1) overheat the battery
  - (2) reduce the electrolyte level
  - (3) cause failures in battery
- Never inverse the connection of [(+) terminal and (-) terminal]. Doing so can cause damage on alternator.
  - Remove the battery cable when handling the battery other than for battery electrolyte level check and specific gravity measurement.

## 8.4 STARTING ENGINE WITH BOOSTER CABLE

Start the engine with booster cable as described below.

### [1] CAUTIONS IN CONNECTING/DISCONNECTING BOOSTER CABLE

#### ⚠ WARNING

- Never let the (+) terminal and (-) terminal come into contact with the other when connecting the cable.
- Wear goggles and rubber gloves when starting the engine with the booster cable.
- Do not let the normal machine and machine in failure come into contact with the other.  
Because the battery produces hydrogen gas, sparks around the battery can cause explosion.
- Do not make mistakes in connecting the booster cable. Note that there will be some sparks when making the last connection. Make this connection at the location as far as possible from the battery.
- Do not let the booster cable clips contact the other or machine when disconnecting the booster cable.

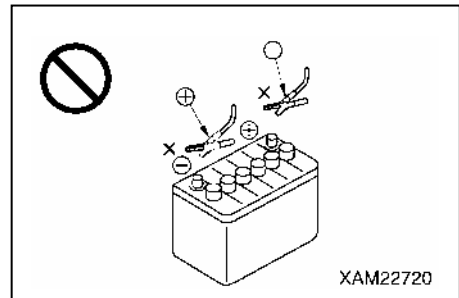

#### CAUTION

- Use booster cable and clips of appropriate size for the battery size.
- The battery in the normal machine and machine in failure should be of the same capacity.
- Check that the cable and clips have no breakage and corrosion.
- Connect the clips securely.
- Verify that the operation levers are at the “NEUTRAL” position.

### [2] CONNECTING BOOSTER CABLE

Connect the booster cable in the numerical order shown in the figure on the right.

1. Turn the starter switch of both of the normal machine and machine in failure to the “OFF” position.
2. Connect a clip of the booster cable (A) to the (+) terminal of the machine in failure.
3. Connect the other clip of the booster cable (A) to the (+) terminal of the normal machine.
4. Connect a clip of the booster cable (B) to the (-) terminal of the normal machine.
5. Connect the other clip of the booster cable (B) to the engine block of the machine in failure.

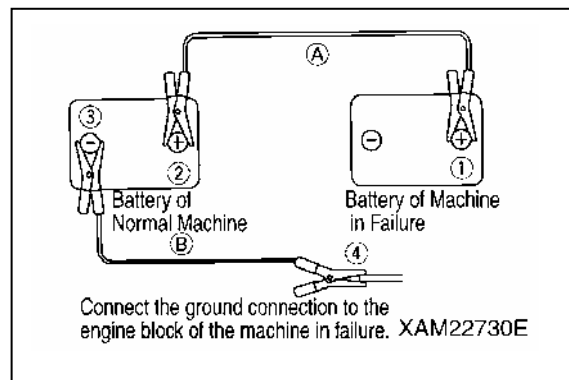

### [3] STARTING ENGINE

#### **⚠ CAUTION**

Verify that the operation levers are at the "NEUTRAL" position. If the safety lock lever is equipped, also verify that the safety lock lever is at the lock position.

1. Verify that the clips are securely connected to the battery terminals.
2. Start the engine of the normal machine and increase the engine speed to full speed (highest speed).
3. Turn the starter switch of the machine in failure to the "START" position to start the engine.

If the engine does not start, wait for more than 2 minutes before re-starting.

#### **NOTES**

See "Operation 2.2 Starting Engine" for how to start the engine.

### [4] DISCONNECTING BOOSTER CABLE

When the engine started, disconnect the booster cable in the reverse order of connecting the booster cable.

1. Disconnect the clip of the booster cable (B) connected to the engine block of the machine in failure.
2. Disconnect the clip of the booster cable (B) connected to the (-) terminal of the normal machine.
3. Disconnect the clip of the booster cable (A) connected to the (+) terminal of the normal machine.
4. Disconnect the clip of the booster cable (A) connected to the (+) terminal of the machine in failure.

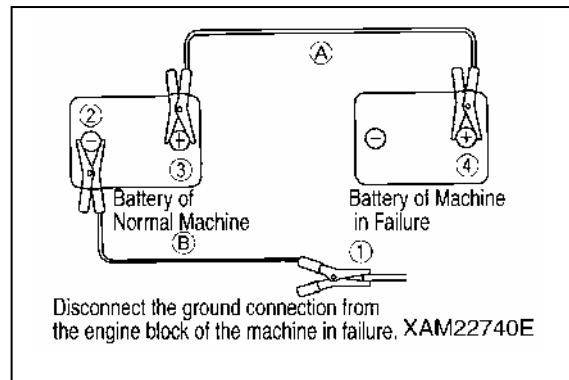

## 9. TROUBLESHOOTING

### 9.1 ELECTRICAL COMPONENTS

- Make sure that you contact us or our sales service agency for the actions indicated in parentheses in the Actions field.
- Ask our sales service agency for repair if you suspect other abnormality or causes than those given below.

| <b>Abnormal Phenomenon</b>  | <b>Major Cause(s)</b>                                | <b>Actions</b>   |
|---|--|--|
| Dark light even at highest engine speed                                 | • Defective wiring                                   | (• Check and repair slackened terminals and open circuits) |
| Light blinks during engine operation                                    | • Defective alternator<br>• Defective wiring         | (• Replace)<br>(• Check and repair)                        |
| Battery charge monitor remains illuminated even after the engine starts | • Defective alternator<br>• Defective wiring         | (• Replace)<br>(• Check and repair)                        |
| Abnormal noise from alternator  | • Defective alternator                               | (• Replace)  |
| Starter not rotating even after the starter switch is turned            | • Defective wiring<br>• Insufficient battery charge  | (• Check and repair)<br>• Charge the battery               |
| Starter pinion going out and in repeatedly (struggling)                 | • Insufficient battery charge                        | • Charge the battery                                       |
| Starter key turning slow  | • Insufficient battery charge<br>• Defective starter | • Charge the battery<br>(• Replace)                        |
| Starter disengaged before the engine starts                             | • Defective wiring<br>• Insufficient battery charge  | (• Check and repair)<br>• Charge the battery               |



## 9.2 MACHINE BODY

- Make sure that you contact us or our sales service agency for the actions indicated in parentheses in the Actions field.
- Ask our sales service agency for repair if you suspect other abnormality or causes than those given below.

| <b>Abnormal Phenomenon</b>  | <b>Major Cause(s)</b>  | <b>Actions</b>   |
|---|--|--|
| Crane cannot operate but can travel   | <ul style="list-style-type: none"> <li>• Work selector switch not at "CRANE"</li> </ul>  | <ul style="list-style-type: none"> <li>• Operate the work selector switch to "CRANE"</li> </ul>  |
| <ul style="list-style-type: none"> <li>• Traveling speed, boom and hook block operation speed too slow</li> <li>• Abnormal noise from pump</li> </ul> | <ul style="list-style-type: none"> <li>• Insufficient hydraulic oil</li> <li>• Hydraulic oil tank strainer and element clogged</li> </ul>                            | <ul style="list-style-type: none"> <li>• Refill with hydraulic oil to the specified oil level, referring to the section "Check before operation"</li> <li>• Clean and replace the filter by referring to the "Periodical Checks".</li> </ul> |
| Hydraulic oil temperature too high  | <ul style="list-style-type: none"> <li>• Insufficient hydraulic oil</li> <li>• Between cooling fins clogged</li> </ul>   | <ul style="list-style-type: none"> <li>• Refill with hydraulic oil to the specified oil level, referring to the section "Check before operation"</li> <li>• Clean</li> </ul>   |
| <ul style="list-style-type: none"> <li>• Rubber tracks coming off</li> <li>• Abnormal wear on the sprockets</li> </ul>                                | <ul style="list-style-type: none"> <li>• Rubber tracks too loose</li> </ul>  | <ul style="list-style-type: none"> <li>• See "Check before operation" and adjust the tension</li> </ul>  |
| Outriggers cannot operate   | <ul style="list-style-type: none"> <li>• Outrigger rotary not rotated to extension position (outward).</li> <li>• Work selector switch not at "OUTRIGGER"</li> </ul> | <ul style="list-style-type: none"> <li>• Secure the rotary at the extension position</li> <li>• Operate the work selector switch to "OUTRIGGER"</li> </ul>   |
| Crane and outriggers cannot operate   | <ul style="list-style-type: none"> <li>• Work selector switch at "DRIVE"</li> </ul>  | <ul style="list-style-type: none"> <li>• Operate the work selector switch to "OUTRIGGER" or "CRANE"</li> </ul>   |

### 9.3 ENGINE

- Make sure that you contact us or our sales service agency for the actions indicated in parentheses in the Actions field.
- Ask our sales service agency for repair if you suspect other abnormality or causes than those given below.

| Abnormal Phenomenon   | Major Cause(s)  | Actions   |
|---|---|---|
| Engine does not start even after the starter key is turned                    | <ul style="list-style-type: none"> <li>• Insufficient fuel</li> <li>• Insufficient battery charge</li> <li>• Insufficient compression</li> </ul>  | <ul style="list-style-type: none"> <li>• See “Check before operation” and refuel</li> <li>• Charge the battery (• Check and replace)</li> </ul>   |
| Engine starts but stops right away  | <ul style="list-style-type: none"> <li>• Insufficient oil in oil pan</li> </ul>   | <ul style="list-style-type: none"> <li>• See “Check before operation” and adjust oil level to appropriate one</li> <li>• See causes and actions for “Engine does not start”</li> </ul>  |
| Engine power is low, the power gradually drops                                | <ul style="list-style-type: none"> <li>• Air cleaner element clogged</li> <li>• Radiator fin clogged</li> <li>• Insufficient compression</li> </ul>   | <ul style="list-style-type: none"> <li>• See “Periodical Maintenance” for cleaning or replacement of the parts</li> <li>• Clean (• Check and replace)</li> </ul>  |
| Engine water temperature monitor illuminates while the engine is in operation | <ul style="list-style-type: none"> <li>• Insufficient cooling water</li> <li>• Water leakage from the cooling line</li> <li>• Slackened or broken fan belt</li> <li>• Radiator fin clogged</li> </ul> | <ul style="list-style-type: none"> <li>• See “Check before operation” and refill with cooling water (• Check and repair)</li> <li>• See “Periodical Maintenance” to check, adjust, or change the belt</li> <li>• Check and clean</li> </ul> |
| Engine oil pressure monitor illuminates while the engine is in operation      | <ul style="list-style-type: none"> <li>• Insufficient engine oil</li> <li>• Engine oil filter clogged</li> <li>• Engine unit in failure</li> </ul>  | <ul style="list-style-type: none"> <li>• See “Check before operation” and adjust oil level to appropriate one</li> <li>• See “Periodical Maintenance” to check, adjust, or change the filter (• Check and repair)</li> </ul>                |



# INSPECTION AND MAINTENANCE

|   |      |
|---|------|
| 1. PRECAUTIONS FOR MAINTENANCE                    | 4- 2 |
| 2. BASIC MAINTENANCE                              | 4- 4 |
| 3. LEGAL INSPECTION                               | 4- 6 |
| 4. CONSUMABLES                                    | 4- 6 |
| 5. LUBRICATING OIL                                | 4- 7 |
| 6. ACCESSORY TOOLS AND STANDARD TIGHTENING TORQUE | 4- 8 |
| 7. INSPECTION AND MAINTENANCE LIST                | 4-10 |
| 8. MAINTENANCE PROCEDURES                         | 4-12 |

# 1. PRECAUTIONS FOR MAINTENANCE

Thorough understanding of the inspection and maintenance items is required to perform efficient inspection and maintenance that contributes to safe use of this machine.

## **⚠ WARNING**

- Do not perform any inspection or maintenance that is not described in this manual. Potential serious accident or machine failure may occur if it is performed at the discretion of the individual.  
In the event that a judgment on the severity of a failure or malfunction is unable to be made, contact us or our sales service agency to request repair.
- In the event that a failure or malfunction is encountered in machine operation or found in inspection, report it to your employer or supervisor immediately. Contact us or our sales service agency to request repair accordingly.
- Inspection and maintenance should be performed with the machine placed on a level and strong footing.

### **[1] CHECK THE SERVICE METERS**

Read the service meters daily to check for any maintenance item that reached the obligatory maintenance period.

### **[2] USE GENUINE PARTS FOR REPLACEMENT**

Always use Maeda genuine parts as specified in the parts catalogue for part replacement.

### **[3] USE PURE GREASE**

Always use Maeda pure grease. The viscosity of grease must conform to specifications according to ambient temperature.

### **[4] USE CLEAN OIL AND GREASE**

Always use clean oil, grease, and container to keep impurities out of them.

### **[5] KEEP THE MACHINE CLEAN**

Keep the machine clean to facilitate the detection of a malfunction. Especially keep the grease nipple, breather, and oil level gauge (oil access door) clean to prevent impurities from finding their way into the machine.

### **[6] HANDLE WATER AND OIL AT ADEQUATE TEMPERATURE**

Drainage, drain oil, and exhaust filter will be at elevated temperatures immediately after the machine comes to a stop. Replace drainage, drain oil, and filter only after they drop in temperature for safety.

If the oil is cold, raise the temperature of the oil to approx. 20 to 40°C.

### **[7] CHECK DRAIN OIL AND OIL FILTER**

For replacement of oil and filter, check the drain oil and exhaust filter to make sure no a considerable amount of metal powder or foreign objects is present.

### **[8] CAUTIONS FOR LUBRICATION**

Do not remove the strainer to lubricate if it is attached to the lubrication opening.

### **[9] PROTECT OIL FROM IMPURITIES**

Avoid dust when inspecting and replacing the oil to keep impurities out of the oil.

### **[10] ATTACH A WARNING TAG**

When draining coolant and oil, always attach a warning tag to the traveling operation unit for the prevention of accidental engine starting.

### **[11] FOLLOW SAFETY PRECAUTIONS**

Safety precautions provided on the machine should always be followed when using the machine.

## **[12] CAUTIONS FOR WELD REPAIR**

- Power off the machine. (Turn OFF the start switch)
- Do not continuously apply 200V or greater.
- Ground the machine within 1 meter from the welding point.
- Be sure to disconnect the connectors of the remote controller, moment limiting indicator, and moment limiting converter.
- Remove the negative terminal (-) of the battery.
- Make sure no sealing or bearing is present between the welding point and the grounding point. Potential damage to sealing may occur due to sparks if disregarded.
- Do not ground around the boom pin or the hydraulic cylinder. Potential damage to a plated section may occur due to sparks if disregarded.

## **[13] KEEP FROM FLAME**

Always clean the parts with noncombustible cleaning agent or light oil.

Keep the machine from flame when using light oil.

## **[14] KEEP THE ATTACHMENT SURFACE CLEAN**

Be sure to clean the attachment surface after removing a part to which the O-ring and gasket sealing are attached.

Replace the part with a new one with the O-ring and gasket reattached.

## **[15] Empty YOUR POCKETS**

Always empty your pockets before performing inspection and maintenance of the machine in a downward direction with the cover opened.

## **[16] ASSURE SAFE RUBBER TRACK**

When performing crane operation in a rocky location, make sure of no damage to the rubber track and no looseness, cracks, abrasion of bolts and nuts. Loosen the tension of the crawler tread more than usual.

## **[17] CAUTIONS FOR MACHINE WASH**

- Do not direct a jet of steam to the electrical parts and connector.
- Keep the operation panel dry.
- Wash the machine with clean cloth, rinsing off dirt and dust.

## **[18] PRE- AND POST-WORK INSPECTION**

Before performing crane operation in the muddy water, rain, snow and on the seashore, always check plugs and valves for looseness. Post-work inspection requires check all the units for cracks and damages and check bolts and nuts for looseness and coming off, with the machine washed.

Carry out early greasing. Grease the operating pin that enters the muddy water on a daily basis.

## **[19] CAUTIONS FOR WORKING IN A DUSTY SITE**

The following precautions should be observed when working in a dusty site.

- Occasionally check the air cleaner for clogging.
- Clean and replace the fuel filter in a timely manner.
- Be sure to clean the electrical parts, especially the starter and alternator, to protect them from dust.

## **[20] DO NOT MIX OIL**

Never use together with different types of oil under any circumstance.

Replace the oil entirely when replenishing a different type of oil.

Always use Maeda genuine parts for part replacement.

## **2. BASIC MAINTENANCE**

### **[1] OIL HANDLING**

- Oil is used under extremely harsh conditions (high temperature, high pressure) in the engine and working device, which causes the oil to undergo deterioration with operating time.  
Always use oil that meets requirements such as grade and operating temperature defined in the operation manual. Be sure to perform periodic replacement of oil irrespective of contamination in the oil.
- Oil is equivalent to human blood. Exercise due caution to handle oil, keeping impurities (such as water, metal powder or dust) out of oil. Most of mechanical failures are attributed to intrusion of impurities.  
Extra caution is required to prevent impurities from finding their way during machine storage and lubrication.
- Do not mix oil with other oil of different grade or brand.
- Oil lubrication must conform to the designated quantity of oil.  
Failure to lubricate at adequate quantity can lead to a machine failure.
- In the event that oil used in the working device turns cloudy, potential intrusion of moisture or air into the oil may be considered. Contact us or our sales service agency.
- When replacing oil, always replace the relevant filter as well.
- "ISO VG32" is adopted for a hydraulic oil system as factory default.  
Do not use any other hydraulic oil that is not recommended by us. Failure to follow the instruction may cause the filters to get clogged. A minute amount of oil remaining in piping and cylinders does not cause problems even if mixed with other oil.

### **[2] FUEL HANDLING**

- The fuel pump is precision equipment that becomes inoperative if fuel containing moisture or impurities is used. Extra caution is required to prevent impurities from finding their way during machine storage and lubrication.
- Do not remove the strainer when replenishing fuel.
- Always use fuel that meets requirements such as grade and operating temperature defined in the operation manual.
- Ensure that the fuel tank is filled up after finishing daily work to prevent condensation of the humid air inside the fuel tank that will result in intrusion of moisture.
- Drain deposits and water out of the fuel tank before starting the engine or approximately 10 minutes after fuel replenishment.
- The air should be released from the circuit when the machine runs out of fuel or fuel filter replacement is performed.
- Clean the tank and fuel system if any foreign objects enter the fuel tank.

### **[3] STOCKING AND STORAGE OF OIL AND FUEL**

- Stock and store oil and fuel indoors to keep impurities such as moisture or dust out of them.
- When storing oil and fuel in drums for a long time, line the drums horizontally aligning the drum bungs sideways (to store them away from moisture). Be sure to cover the drums with a waterproof sheet if storing them outside.
- To prevent deterioration of oil and fuel resulted from long-term storage, employ the first-in first-out for using oil and fuel.

### **[4] GREASE HANDLING**

- Grease is designed to prevent the joint from rattling and making noise.
- A nipple that is not described in the Periodic Maintenance chapter is used for overhauls, which requires no grease replenishment. Grease the nipple if a long-term use hinders its smoothness.
- Wipe off old grease squeezed out after greasing. Extra care is required to wipe a part that the adhesion of sands and dust accelerates the wearing away of the rotating part.

## **[5] FILTER HANDLING**

- A filter is an extremely important part that keeps major equipment free from impurities in oil, fuel, and the air circuit, which prevents an associated failure. Periodic replacement of the filter is required in accordance with the Operation Manual. The replacement period should be shortened in responses to harsh operating environments or the oil used.
- Do not reuse any washed filters (cartridge type one) under any circumstances.
- After replacing an oil filter, check the used filter for any metal powder.  
If check finds metal powder on the used filter, contact us or our sales service agency.
- As to a replacement filter, always unpack it immediately prior to its use.
- Always use Maeda genuine filters.

## **[6] COOLANT HANDLING**

- The river water contains a large amount of calcium and impurities. Use of the river water results in accumulation of water stain in the engine and radiator, which causes heat exchange error leading to overheat. Do not use any non-potable water.
- Always use antifreeze following precautions stated in the Operation Manual.
- Keep antifreeze from flame. Antifreeze is a flammable solution.
- The mixing proportion of antifreeze varies with outside air temperature. See “Maintenance 8.11 Every 1000 Hours [2] Cleaning engine cooling system” for the mixing proportions.
- In the event of overheating, replenish coolant with the engine cold.
- The machine low in coolant may cause overheating and corrosion attributed to aeration.

## **[7] ELECTRICAL PART HANDLING**

- The electrical parts are susceptible to water damage and damaged coating. A current leakage is developed if the electrical parts are wetted or have damaged coating, which causes the machine to go out of order and malfunction. Exercise due caution to handle the electrical parts.
- Inspection and maintenance include the checking of belt tension, belt damage, and battery electrolyte level.
- Never remove and disassemble equipment (electrical parts) from the machine.
- Only optional electrical parts that accompany the machine can be installed.
- Keep the electrical parts away from water when the machine is washed and used in the rain.
- When using the machine at the seashore, keep the electrical parts free of water and impurities to prevent corrosion.

## **[8] HYDRAULIC EQUIPMENT HANDLING**

- Hydraulic equipment will be at elevated temperatures during and immediately after operation. Hydraulic equipment operates under high pressure. The following precautions should be observed when performing inspection and maintenance of hydraulic equipment.
  - Place the machine in travel position on a level surface to inhibit the application of pressure to the cylinder circuit.
  - Be sure to stop the engine.
  - Hydraulic oil and lubricating oil will be at elevated temperatures and high pressure immediately after equipment comes to a stop. Perform inspection and maintenance only after the oil drop in temperature for safety. An internal pressure may be exerted despite temperature drop. When removing the plugs, screws and hose joints, stand aside and provide gradual loosening to decompress.
  - Be sure to remove the pressure releasing air from the hydraulic oil tank before performing inspection and maintenance of the hydraulic circuit.
- Inspection and maintenance include hydraulic oil level check and replacement of the filters and hydraulic oil.
- Check the O-ring for scratches when removing the high-pressure hose. If check finds scratches, replace the O-ring.
- Air bleed of the hydraulic circuit is required after the following tasks are performed: replacement and cleaning of the hydraulic oil filter element and strainer, repair and replacement of hydraulic equipment, and hydraulic piping replacement.



### 3. LEGAL INSPECTION

If periodic inspection for machine safety assurance is stipulated by laws and regulations of your country, perform inspection complying with the inspection items listed below.

1. Make sure no abnormal event is present in the safety devices.
2. Check the hoisting accessories including a hook block for any abnormalities.
3. Check the winch wire rope end and wire clip for breakage.
4. Replace the wire rope promptly if it is damaged.
5. Check the hydraulic hose for oil leaks and friction flaws on the surface. Replace the hose if a surface flaw is detected.
6. Check the structural part including a boom for cracks and deformations.
7. Check the mounting bolts and joints for looseness and falling off.
8. Check if the booms perform proper operation and stop in extending, retracting, raising, lowering, and slewing.

If check finds a malfunction, contact us or our sales service agency.

### 4. CONSUMABLES

Consumables such as a filter element and wire rope are to be replaced upon periodic maintenance or prior to the wear limit. Proper replacement of consumables delivers increased economy in machine use.

Always use Maeda genuine parts for part replacement.

See the parts catalogue for part numbers when ordering parts.

#### [LIST OF CONSUMABLES]

| Part                        | Replacement cycle |
|-----------------------------|-------------------|
| Hydraulic oil return filter | Every 500 hrs     |
| Cylinder gasket             | ★3 yrs            |
| Boom slide plate            | Every 3 yrs       |
| Winch wire rope             | ★Every 3 yrs      |
| Boom extending wire rope    | ★Every 3 yrs      |
| Boom retracting wire rope   | ★Every 3 yrs      |

★The cycles marked with a “★” in Replacement cycle include a halt period.

★Contact us or our sales service agency for part replacement.

## 5. LUBRICATING OIL

### 5.1 USE OF LUBRICATING OIL ACCORDING TO TEMPERATURES

Use of lubricating oil should vary with changes in temperature.

| Lubricating place    | Type of oil   | Use by temperature         |           |           |         |          |          |          |           |                | Specified capacity (liter) | Volume to replace (liter) |
|----------------------|---------------|----------------------------|-----------|-----------|---------|----------|----------|----------|-----------|----------------|----------------------------|---------------------------|
|                      |               | -22<br>-30                 | -4<br>-20 | 14<br>-10 | 32<br>0 | 50<br>10 | 68<br>20 | 86<br>30 | 104<br>40 | 122°F<br>50 °C |                            |                           |
| Engine oil pan       | Engine oil    |                            |           |           |         |          |          |          |           |                | 3.1                        | 3.1                       |
|                      |               |                            |           |           |         |          |          |          |           |                |                            |                           |
|                      |               |                            |           |           |         |          |          |          |           |                |                            |                           |
|                      |               |                            |           |           |         |          |          |          |           |                |                            |                           |
| Hydraulic oil tank   | Hydraulic oil |                            |           |           |         |          |          |          |           |                | 60                         | 44                        |
|                      |               |                            |           |           |         |          |          |          |           |                |                            |                           |
| Swing reducer        | Gear oil      |                            |           |           |         |          |          |          |           |                | 0.6                        | 0.6                       |
| Winch reducer        |               |                            |           |           |         |          |          |          |           |                | 0.75                       | 0.75                      |
| Travel motor reducer |               |                            |           |           |         |          |          |          |           |                | 0.7                        | 0.7                       |
| Fuel tank            | Diesel fuel   |                            |           |           |         |          |          |          |           |                | 40                         | —                         |
| Cooling system       | Water         | Nonfreezing fluid addition |           |           |         |          |          |          |           |                | 3.5                        | —                         |

- A specified oil quantity is defined as a total quantity of oil including that for unit piping, and a replacement oil quantity is defined as a quantity of oil to be replaced at inspection and maintenance.
- Always use SAE10W-CD, SAE10W-30CD, or SAE10W-40CD to start the engine with temperature at 0°C or below despite rise in diurnal temperature to approx. 10°C.
- Be sure to use our recommended abrasion-resistant hydraulic oil for the hydraulic oil system; ISO VG46 and VG32.  
"Nippon Oil Super Highland 32" is adopted for a hydraulic oil system as factory default.
- For adjustment of antifreeze concentrations in coolant with temperature at -10°C or below, see "Maintenance 8.11 Every 1000 Hours [2] Cleaning Engine cooling system.

#### CAUTION

- Molybdenum disulfide filled grease is to be applied to the boom slide plate (top), both sides and bottom of the boom.
- Do not apply molybdenum disulfide filled grease to the slewing bearing.

## 6. ACCESSORY TOOLS AND

### STANDARD TIGHTENING TORQUE

#### 6.1 ACCESSORY TOOLS

Contact us or our sales service agency to request a tool for inspection and maintenance, when necessary.

#### 6.2 STANDARD TIGHTENING TORQUE LIST

Torque the metric bolts and nuts with no specific indication to a values shown in this table.

Adequate tightening torque is determined with respect to a width across flat (b) of a bolt or nut.

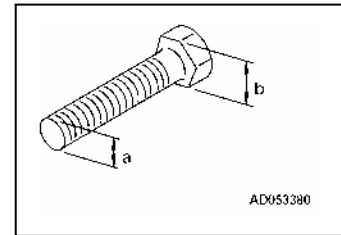

[Table 1]

| Nominal size<br>(a; mm) | Width across flat<br>(b; mm) | [1] Bolt marked with “8.8” (strength classification) on its head |                       | [2] Bolt marked with “10.9” (strength classification) on its head |                      |
|-------------------------|------------------------------|--|-----------------------|---|----------------------|
|                         |                              | Tightening torque {N•m (kgf•m)}                                  |                       | Tightening torque {N•m (kgf•m)}                                   |                      |
|                         |                              | Target value   | Tolerance             | Target value  | Tolerance            |
| 6                       | 10                           | 7.8 (0.80)   | 6.8-9.0 (0.70-0.92)   | 11.0 (1.1)  | 9.4-12.7 (0.93-1.26) |
| 8                       | 13                           | 19.0 (1.95)  | 16.5-21.9 (1.70-2.24) | 27.0 (2.7)  | 23.0-31.1 (2.3-3.10) |
| 10                      | 17                           | 37.5 (3.85)  | 32.6-43.1 (3.35-4.43) | 53.0 (5.4)  | 45.0-61.0 (4.6-6.21) |
| 12                      | 19                           | 65.5 (6.70)  | 57.0-75.3 (5.85-7.70) | 93.0 (9.5)  | 79.0-107 (8.10-10.9) |
| 14                      | 22                           | 104 (10.6)   | 90.4-120 (9.2-12.2)   | 148 (15.1)  | 126-170 (12.8-17.4)  |
| 16                      | 24                           | 163 (16.6)   | 142-187 (14.4-19.1)   | 231 (23.5)  | 196-266 (20.0-27.0)  |
| 18                      | 27                           | 224 (22.8)   | 195-258 (19.8-26.2)   | 317 (32.3)  | 269-365 (27.5-37.1)  |
| 20                      | 30                           | 318 (32.4)   | 277-366 (28.2-37.3)   | 450 (45.9)  | 383-518 (39.0-52.8)  |
| 22                      | 32                           | 432 (44.0)   | 376-497 (38.3-50.6)   | 612 (62.4)  | 520-704 (53.0-71.8)  |
| 24                      | 36                           | 549 (56.0)   | 477-631 (48.7-64.4)   | 778 (79.3)  | 661-895 (67.4-91.2)  |
| 27                      | 41                           | 804 (81.9)   | 699-925 (71.2-94.2)   | 1130 (116)  | 961-1300 (98.6-133)  |
| 30                      | 46                           | 1090 (111)   | 948-1250 (96.5-128)   | 1540 (158)  | 1310-1770 (134-182)  |
| 33                      | 50                           | 1485 (151)   | 1290-1710 (131-174)   | 2100 (214)  | 1790-2410 (182-246)  |
| 36                      | 55                           | 1910 (194)   | 1660-2200 (167-223)   | 2700 (275)  | 2300-3100 (234-316)  |

[Table 2]

| Nominal size (a; mm) | Width across flat (b; mm) | [3] Bolt marked with “12.9” (strength classification) on its head |                       | [4] Other bolts                 |                       |
|----------------------|---------------------------|---|-----------------------|---------------------------------|-----------------------|
|                      |                           | Tightening torque {N•m (kgf•m)}                                   |                       | Tightening torque {N•m (kgf•m)} |                       |
|                      |                           | Target value  | Tolerance             | Target value                    | Tolerance             |
| 6                    | 10                        | 13.0 (1.30)   | 11.1-15.0 (1.11-1.50) | 3.0 (0.30)                      | 2.6-3.5 (0.26-0.35)   |
| 8                    | 13                        | 31.5 (3.20)   | 26.8-36.2 (2.72-3.70) | 7.5 (0.75)                      | 6.5-8.6 (0.65-0.85)   |
| 10                   | 17                        | 62.5 (6.40)   | 53.1-71.9 (5.44-7.35) | 14.5 (1.45)                     | 12.6-16.7 (1.25-1.65) |
| 12                   | 19                        | 109 (11.1)  | 92.7-125 (9.44-12.8)  | 25.0 (2.55)                     | 21.7-28.8 (2.20-2.95) |
| 14                   | 22                        | 174 (17.7)  | 148-200 (15.0-20.4)   | 40.0 (4.10)                     | 34.8-46.0 (3.55-4.70) |
| 16                   | 24                        | 271 (27.7)  | 230-312 (23.5-31.9)   | 62.5 (6.40)                     | 54.3-71.9 (5.55-7.35) |
| 18                   | 27                        | 373 (38.1)  | 317-429 (32.4-43.8)   | 86.0 (8.75)                     | 74.8-98.9 (7.60-10.0) |
| 20                   | 30                        | 529 (54.0)  | 450-608 (45.9-62.1)   | 122 (12.4)                      | 106-140 (10.8-14.3)   |
| 22                   | 32                        | 720 (73.4)  | 612-828 (62.4-84.4)   | 166 (16.9)                      | 144-191 (14.7-19.4)   |
| 24                   | 36                        | 915 (93.3)  | 778-1050 (79.3-107)   | 211 (21.5)                      | 183-243 (18.7-24.7)   |
| 27                   | 41                        | 1340 (136)  | 1140-1540 (116-156)   | 309 (31.4)                      | 269-355 (27.3-36.1)   |
| 30                   | 46                        | 1820 (185)  | 1550-2090 (157-213)   | 419 (42.6)                      | 364-482 (37.0-49.0)   |
| 33                   | 50                        | 2470 (252)  | 2100-2840 (214-290)   | 570 (58.0)                      | 495-656 (50.4-66.7)   |
| 36                   | 55                        | 3180 (324)  | 2700-3660 (275-373)   | 732 (74.5)                      | 636-842 (64.8-85.7)   |

## 7. INSPECTION AND MAINTENANCE LIST

| Inspection and maintenance items  | Page |
|---|------|
| <b>8.1 INITIAL 10 HOUR MAINTENANCE</b> (Only the first maintenance of a new machine)  | 4-12 |
| [1] GREASING MACHINE UNITS  | 4-26 |
| <b>8.2 INITIAL 50 HOUR MAINTENANCE</b> (Only the first maintenance of a new machine)  | 4-12 |
| [1] REPLACEMENT ENGINE LUBRICATING OIL AND OIL FILTER CARTRIDGE                       | 4-29 |
| [2] OIL REPLACEMENT IN HYDRAULIC OIL TANK   | 4-41 |
| [3] REPLACEMENT HYDRAULIC OIL RETURN FILTER CARTRIDGE                                 | 4-34 |
| [4] REPLACEMENT HYDRAULIC OIL SUCTION FILTER  | 4-35 |
| [5] CHECKING / ADJUSTMENT ALTERNATOR BELT TENSION                                     | 4-31 |
| <b>8.3 INITIAL 250 HOUR MAINTENANCE</b> (Only the first maintenance of a new machine) | 4-12 |
| [1] OIL REPLACEMENT IN SLEWING REDUCTION GEAR CASE                                    | 4-43 |
| [2] OIL REPLACEMENT IN WINCH MOTOR REDUCTION GEAR CASE                                | 4-44 |
| [3] OIL REPLACEMENT IN TRAVELING MOTOR REDUCTION GEAR CASE                            | 4-45 |
| <b>8.4 INSPECTION OF BEFORE OPERATION</b>   | 4-12 |
| <b>2.1.1 CHECKING BEFORE STARTING ENGINE (VISIBLE CHECKS)</b>                         | 3-40 |
| [1] CHECKING AROUND CRANE   | 3-41 |
| [2] CHECKING WIRE ROPES   | 3-41 |
| [3] CHECKING HOOK BLOCK   | 3-41 |
| [4] CHECKING AROUND OUTRIGGERS  | 3-41 |
| [5] CHECKING UNDERCARRIAGE PARTS  | 3-42 |
| [6] CHECKING AROUND TRAVELING DOLLY   | 3-42 |
| [7] CHECKING AROUND ENGINE  | 3-42 |
| [8] CHECKING AROUND TRAVEL AND CRANE OPERATION SECTION                                | 3-42 |
| <b>2.1.2 CHECKING BEFORE STARTING ENGINE</b>  | 3-43 |
| [1] CHECKING / REFILLING ENGINE COOLING WATER LEVEL                                   | 3-43 |
| [2] CHECKING / REFILLING OIL LEVEL IN ENGINE OIL PAN                                  | 3-44 |
| [3] CHECKING / REFILLING FUEL LEVEL IN FUEL TANK                                      | 3-45 |
| [4] CHECKING / CLEANING WATER SEPARATOR   | 3-46 |
| [5] CHECKING / CLEANING FUEL FILTER POT   | 3-47 |
| [6] CHECKING / REFILLING OIL LEVEL IN HYDRAULIC OIL TANK                              | 3-48 |
| [7] CHECKING / REFILLING OIL LEVEL IN SLEWING REDUCTION GEAR CASE                     | 3-49 |
| [8] CHECKING / REFILLING OIL LEVEL IN TRAVEL MOTOR REDUCTION GEAR CASE                | 3-50 |
| [9] CHECKING / CLEANING RADIATOR AND OIL COOLER FINS                                  | 3-51 |
| [10] CHECKING / REFILLING BATTERY ELECTROLYTE LEVEL                                   | 3-52 |
| [11] CHECKING HORN FOR OPERATION  | 3-53 |
| [12] CHECKING HEADLIGHT FOR OPERATION   | 3-53 |
| [13] CHECKING FUSE BOX FOR DAMAGE   | 3-53 |
| [14] CHECKING OUTRIGGER DISPLAY FOR OPERATION   | 3-54 |
| [15] ADJUSTMENT OPERATION SEAT  | 3-55 |
| <b>2.1.3 CHECKING AFTER STARTING ENGINE</b>   | 3-56 |
| [1] CHECKING / ADJUSTMENT RUBBER TRACK TENSION  | 3-56 |
| [2] CHECKING RUBBER TRACK FOR DAMAGE AND ABRASION                                     | 3-59 |
| [3] CHECKING OUTRIGGER SAFETY DEVICE FOR OPERATION                                    | 3-60 |
| [4] CHECKING OUTRIGGER OPERATION  | 3-62 |
| [5] CHECKING CRANE OPERATION  | 3-63 |

| <b>Inspection and maintenance items</b>                             | <b>Page</b> |
|---|-------------|
| [6] CHECKING OVER HOIST DETECTOR FOR OPERATION                      | 3-64        |
| [7] CHECKING MOMENT LIMITER FOR OPERATION                           | 3-64        |
| [8] CHECKING OUTRIGGER EXTENSION POSITIONS                          | 3-65        |
| [9] CHECKING ENGINE EXHAUST GAS COLOR, NOISE AND VIBRATION          | 3-65        |
| <b>8.5 IRREGULAR MAINTENANCE</b>                                    | 4-13        |
| [1] REPLACEMENT RUBBER TRACK  | 4-13        |
| [2] REPLACEMENT WINCH WIRE ROPE                                     | 4-15        |
| <b>8.6 MAINTENANCE EVERY 30 HOURS</b>                               | 4-22        |
| [1] CHECKING / CLEANING AIR CLEANER ELEMENT                         | 4-22        |
| <b>8.7 MAINTENANCE EVERY 50 HOURS</b>                               | 4-24        |
| [1] DRAINING CONTAMINANT WATER/DEPOSITS IN FUEL TANK                | 4-24        |
| [2] DRAINING CONTAMINANT WATER/DEPOSITS IN WATER SEPARATOR          | 4-25        |
| [3] GREASING MACHINE UNITS  | 4-26        |
| <b>8.8 MAINTENANCE EVERY 250 HOURS</b>                              | 4-28        |
| [1] REPLACEMENT ENGINE LUBRICATING OIL AND OIL FILTER CARTRIDGE     | 4-28        |
| [2] CHECKING / ADJUSTMENT ALTERNATOR BELT TENSION                   | 4-30        |
| [3] CHECKING / REFILLING OIL IN TRAVELING MOTOR REDUCTION GEAR CASE | 4-31        |
| <b>8.9 MAINTENANCE EVERY 500 HOURS</b>                              | 4-32        |
| [1] REPLACEMENT FUEL FILTER CARTRIDGE                               | 4-32        |
| [2] REPLACEMENT HYDRAULIC OIL RETURN FILTER CARTRIDGE               | 4-33        |
| [3] REPLACEMENT HYDRAULIC OIL SUCTION FILTER                        | 4-34        |
| <b>8.10 MAINTENANCE EVERY 1000 HOURS</b>                            | 4-36        |
| [1] REPLACEMENT AIR CLEANER ELEMENT                                 | 4-36        |
| [2] CLEANING ENGINE COOLING SYSTEM                                  | 4-37        |
| [3] OIL REPLACEMENT IN HYDRAULIC OIL TANK                           | 4-40        |
| [4] OIL REPLACEMENT IN SLEWING REDUCTION GEAR CASE                  | 4-42        |
| [5] OIL REPLACEMENT IN WINCH MOTOR REDUCTION GEAR CASE              | 4-43        |
| [6] OIL REPLACEMENT IN TRAVELING MOTOR REDUCTION GEAR CASE          | 4-44        |
| [7] INSPECTION/ADJUSTMENT ENGINE VALVE CLEARANCE                    | 4-44        |
| <b>8.11 MAINTENANCE EVERY 1500 HOURS</b>                            | 4-45        |
| [1] INSPECTION/CLEANING/TESTING FUEL INJECTOR                       | 4-45        |
| [2] CHECKING CRANKCASE BREATHER                                     | 4-45        |
| <b>8.12 MAINTENANCE EVERY 2000 HOURS</b>                            | 4-45        |
| [1] CHECKING/REPAIR ENGINE VALVE SEAT                               | 4-45        |
| [2] CHECKING ALTERNATOR AND STARTER                                 | 4-45        |

## **8. MAINTENANCE PROCEDURES**

### **8.1 INITIAL 10 HOUR MAINTENANCE**

The following maintenance should be performed after 10-hour operation, limited to the first maintenance of a new machine.

#### **[1] GREASING MACHINE UNITS**

See "Maintenance 8.7 Every 50 Hours" for maintenance items and procedure.

### **8.2 INITIAL 50 HOUR MAINTENANCE**

The following maintenance should be performed after 50-hour operation, limited to the first maintenance of a new machine.

#### **[1] REPLACEMENT ENGINE LUBRICATING OIL AND OIL FILTER CARTRIDGE**

See "Maintenance 8.10 Every 500 Hours" for maintenance items and procedure.

#### **[2] OIL REPLACEMENT IN HYDRAULIC OIL TANK**

See "Maintenance 8.11 Every 1000 Hours" for maintenance items and procedure.

#### **[3] REPLACEMENT HYDRAULIC OIL RETURN FILTER**

See "Maintenance 8.10 Every 500 Hours" for maintenance items and procedure.

#### **[4] REPLACEMENT HYDRAULIC OIL SUCTION FILTER**

See "Maintenance 8.10 Every 500 Hours" for maintenance items and procedure.

#### **[5] CHECKING / ADJUSTMENT ALTERNATOR BELT TENSION**

See "Maintenance 8.9 Every 250 Hours" for maintenance items and procedure.

### **8.3 INITIAL 250 HOUR MAINTENANCE**

The following maintenance should be performed after 250-hour operation, limited to the first maintenance of a new machine.

#### **[1] OIL REPLACEMENT SLEWING REDUCTION GEAR CASE**

See "Maintenance 8.11 Every 1000 Hours" for maintenance items and procedure.

#### **[2] OIL REPLACEMENT WINCH MOTOR REDUCTION GEAR CASE**

See "Maintenance 8.11 Every 1000 Hours" for maintenance items and procedure.

#### **[3] OIL REPLACEMENT TRAVELING MOTOR REDUCTION GEAR CASE**

See "Maintenance 8.11 Every 1000 Hours" for maintenance items and procedure.

### **8.4 CHECKING BEFORE OPERATION**

Inspections specified in this section are required to be completed prior to starting an engine first of the day.

See "Maintenance 7. Inspection and Maintenance List" for the inspection and maintenance items

See "Operation 2.1.2 Checking Before Operation" for before operation inspection items and procedure.

## 8.5 IRREGULAR MAINTENANCE

### [1] REPLACEMENT RUBBER TRACK

#### **⚠ WARNING**

- The inside of the tension adjusting device of the rubber track is greased. Grease is under high pressure associated with the tension of the rubber track. Failure to follow precautions stated below when removing grease may lead to a serious accident due to the grease valve being popping out.
- Only one full turn of the tension adjusting grease valve is allowed to loosen. The grease valve may pop out if disregarded.
- Always stand aside when conducting tension adjustment of the grease valve to circumvent potential dangers.
- Ensure that grease is completely removed from the inside of the rubber track before rotating the sprocket to remove the rubber track.

### [REMOVAL RUBBER TRACK]

- Have a steel pipe available.
1. See "Operation 2.14 Outrigger Setting Operation" to set the outriggers and raise the rubber track for about 50mm from the ground.
  2. Loosen the grease valve (1) gradually and remove grease.
  3. Provide only one full turn of the grease valve (1).
  4. Insert the steel pipe between the idler and rubber track, as shown at right. Rotate the sprocket backward.
  5. When the inserted steel pipe detaches the rubber track from the idler, slide the crawler in a lateral direction to remove it.

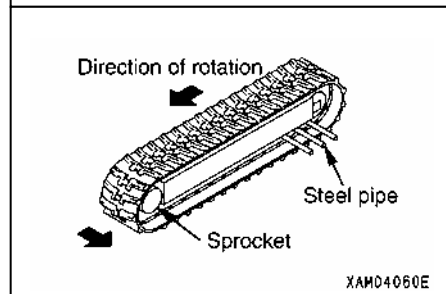
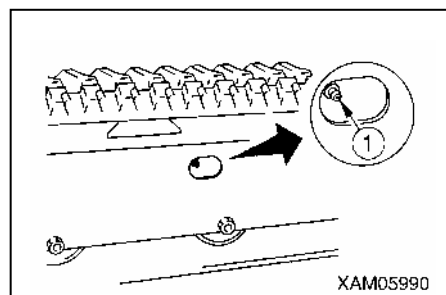



## [INSTALLATION RUBBER TRACK]

- Have a grease gun available.
  - Have a steel pipe available.
1. See “Operation 2.14 Outrigger Setting Operation” to set the outriggers and raise the rubber track again for about 50mm from the ground.
  2. With the rubber track engaged with the sprocket, put the crawler on the idler.
  3. With the sprocket rotating backward, push the rubber track in to stop rotation.
  4. Insert the steel pipe between the idler and rubber track again, and re-rotate the sprocket to put the crawler on the idler properly.
  5. Stop rotation, and ensure that the rubber track is on the sprocket and idler properly.
  6. Make a tension adjustment to the rubber track according to “Operation 2.1.2 Checking Before Operation [9] Checking / adjustment Rubber Track” in the Operation.
  7. Ensure that adequate engagement and tension of the rubber track, sprocket, and idler are obtained.
  8. See “Operation 2.24 Outrigger Stowing Operation” to stow the outriggers and lower the machine on the ground.

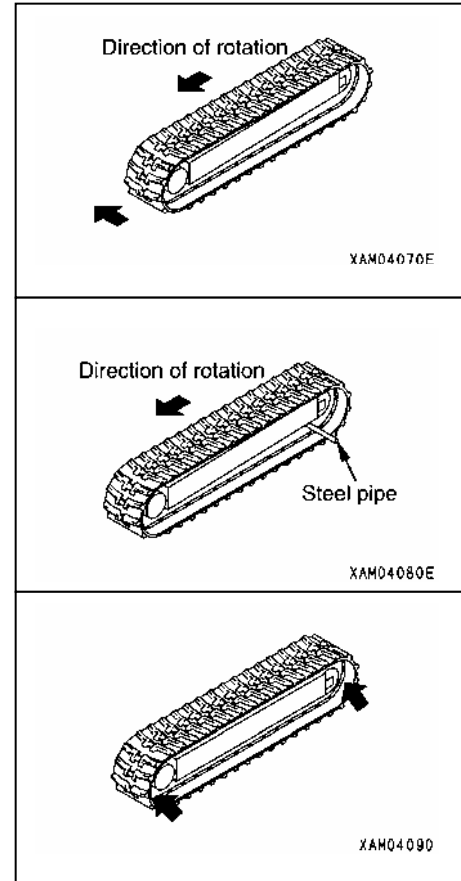

**[2] REPLACEMENT WINCH WIRE ROPE**

**⚠ WARNING**

Always wear work leather gloves when replacing the wire rope.

**CAUTION**

- A diameter of the wire rope is to be measured at points where the wire repeatedly runs through the sheave. A mean value needs to be determined through three-way measurement. (A measurement should be performed at several points, spacing between the points.)
- Do not use the old wire rope regardless of the frequency of use.
- Always use Maeda genuine wire rope.

**[CRITERIA FOR WINCH WIRE ROPE REPLACEMENT]**

A wire rope undergoes wear and tear over time. Prompt replacement is required if any of the following events appears in the wire rope.

- 10% or more of strands (except a filler wire) in a twist of the wire rope (6 crests) is broken.

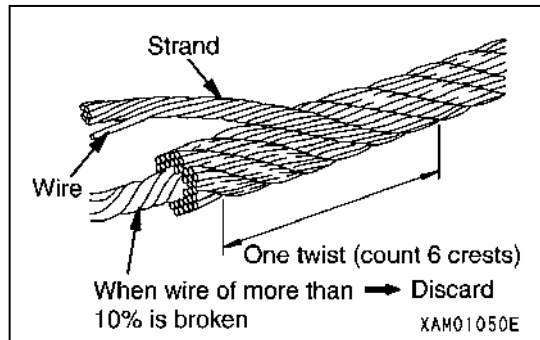

**NOTES**

Change winching/boom telescoping wire rope when 13 or more wires are broken.

- Wear equivalent to 7% or more of a nominal diameter occurs in the wire rope diameter.

**NOTES**

- Replace an 8mm-dia wire rope if it is 7.5mm in diameter.
- Replace a 6mm-dia wire rope if it is 5.6mm in diameter.

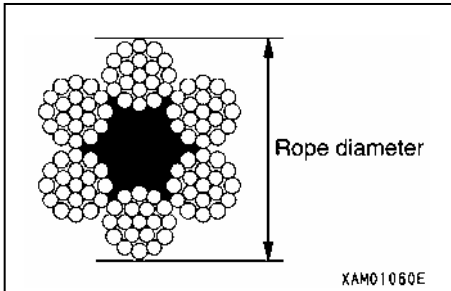

- A kink is formed.
- Considerable deformation or corrosion is developed.
- A faulty end socket is used.

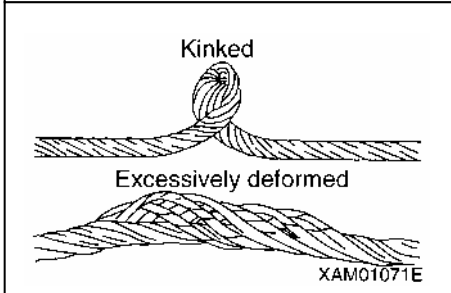

## [REMOVAL WINCH WIRE ROPE]

Use the following procedure to remove the wire rope.

1. Place the machine on a level and firm surface.
2. Place the boom telescoping lever in the "Extend" position (push it toward the front) to extend the boom slightly.
3. Place the winch lever in the "Down" position (push it toward the front) to lift down the hook block on the ground.

4. Undo the wedge socket fixing bolt (2). Remove the wedge socket pin (1) and remove the wedge socket (3).

5. Remove the wire clip (4).

6. Pull the wire rope (5) out of the wedge socket (3), following the procedure provided below.

(1) Bring a 4 to 6mm round bar (6) into contact with the rope wedge (7).

(2) Remove the rope wedge (7), lightly tapping the round bar (6) with a hammer in the direction indicated by the arrow (a).

7. Place the winch lever in the "Down" position (push it toward the front) to wind up the wire rope (5) from the winch drum.

8. With the wire rope winded up from the winch drum, detach the end of the wire rope (5) from the winch drum (8) by following the procedure provided below.

(1) Bring a 4 to 6mm round bar (6) into contact with the rope wedge (9).

(2) Remove the rope wedge (9), lightly tapping the round bar (6) with a hammer in the direction indicated by the arrow (b).

9. Wind up the remaining wire rope (5) completely.

Removal of the winch wire rope is completed.

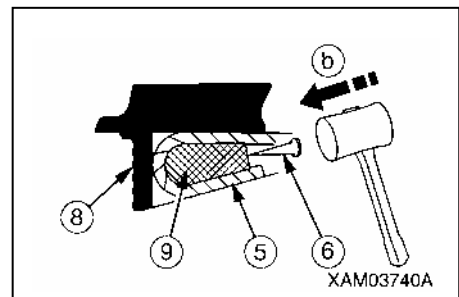
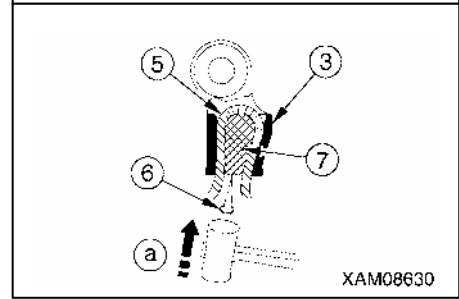
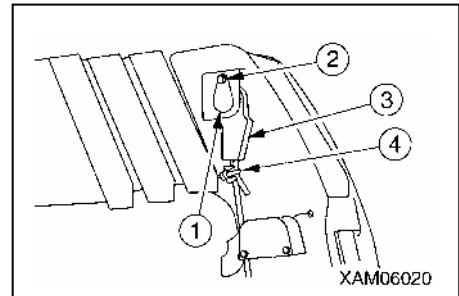

**[INSTALATION WINCH WIRE ROPE]**

**⚠ WARNING**

Be sure to attach the rope wedge properly to secure the wire rope. Potential serious accident may occur due to detachment of the wire rope during crane operation if disregarded.

**CAUTION**

- Avoid irregular winding of the wire rope in the winch drum.
- Always hoist an object (2.9 to 4.9KN {300 to 500kg}) with the boom extended and raised fully immediately after attaching a new rope. Repeat raising and lowering the hook several times until the new rope conforms.
- The wire rope is coiled. Exercise caution not to form a kink in the rope when winding it up. Be sure to unrope by rotating the rope to pull it out of the winch drum.

Use the following procedure to attach the wire rope.

1. With the end of the wire rope held, draw the wire rope (5) through the weight of the over hoist detector, load sheave (1) at the boom end, wire guide (2) of No.2, 3, and 4 boom, snap sheave (3), and idler sheave (4).

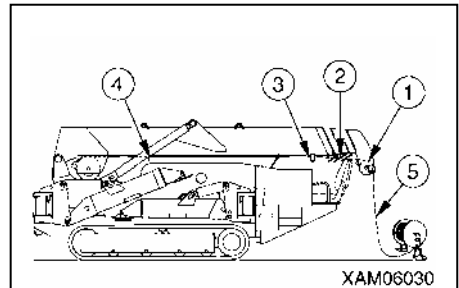

2. Draw the wire rope (5) through the attachment hole of the winch drum (8). Secure the wire rope (5) to the winch drum (8), following the procedure provided below.

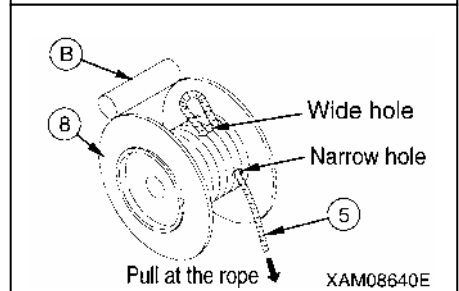

(1) Draw the wire rope (5) through the winch drum (8) with the rope loose.

(2) The rope wedge (9) should be in position (a). Pass the wire rope (5) around the rope wedge and yank at the rope in the direction indicated by the arrow.

Adjust the length of the wire rope (5) to keep the end of the wire rope from protruding from the narrow hole in the winch drum (8).

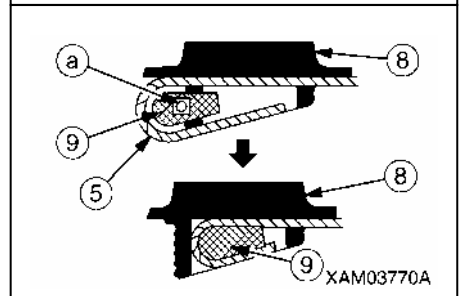

3. Place the winch lever in the “Up” position (pull it toward you) slowly to wind up the wire rope (5) in the winch drum (8).

Ensure that the wire rope is coiled between the irregular winding protective roller (B) and winch drum. The wire rope needs to jut out the boom end (approx. 10m).

4. In response to the number of falls, draw the wire rope through the load sheave at the boom end, hook block sheave, guide sheave, and retraction cam.

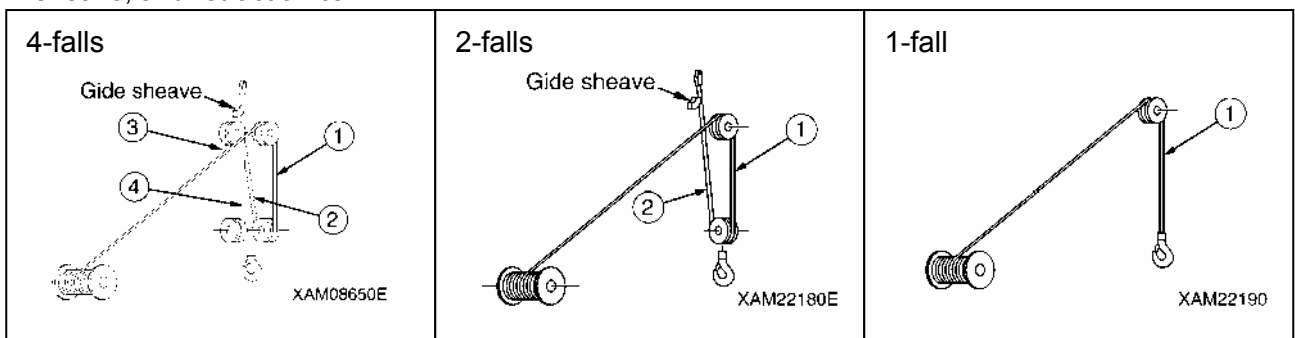

5. Secure the end of the wire rope (5) to the wedge socket (3), following the procedure provided below.

(1) Draw the wire rope (5) through the wedge socket (3) as shown at right.

(2) With the rope wedge (7) in position (a), yank at the wire rope (5) in the direction indicated by the arrow.

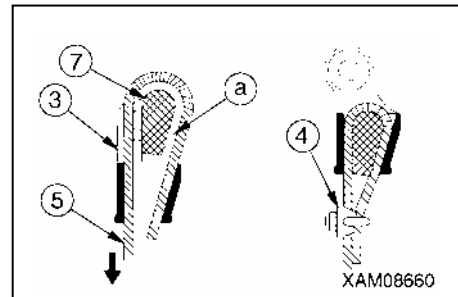

6. Attach the rope clip (4) to the wire rope (5).

7. Secure the wedge socket (3) to the boom with the wedge socket pin (1), and tighten the wedge socket fixing bolt (2).

8. Place the boom derricking lever in the “Raise” position (pull it toward you) or the boom telescoping lever in the “Extend” position (pull it toward you) to raise the hook block.

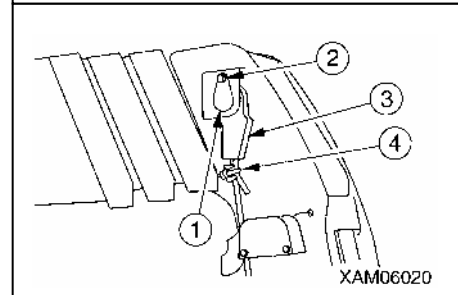

### NOTES

Winch operation is allowed only after the hook block is raised.

9. With the boom extended and raised fully, place the winch lever in the “Down” position (push it toward the front) to adjust the wire rope (5) until 3 to 4 turns of wire are left in the winch drum (8).

10. With the wire rope (5) held under tension, place the winch lever in the “Up” position (pull it toward you) to wind up the wire rope (5) in the winch drum (8).

## [CHECKING BOOM TELESCOPING WIRE ROPE]

Prompt adjustment is required if the following event appears in the boom extending wire rope.

1. Retract the boom completely.
2. Remove three mounting bolts (1) at the boom end and remove the cover (2).
3. Remove lock bolt (6) at the boom telescoping cylinder top, and turn adjustment bolt (9) of the boom extending wire clockwise. The boom extending wire rope (8) is adjusted to the correct tension if boom No.5 extends upon rotating the adjusting bolt (9). If boom No.5 remains retracted, perform proper adjustment according to "Adjustment of boom telescoping wire rope".
4. Check that 5mm clearance is formed between booms No.4 and No.5, clearance (a) shown at right, with the booms retracted in a horizontal position. If check finds clearance of 5mm or more, perform proper adjustment according to "Adjustment of boom telescoping wire rope".

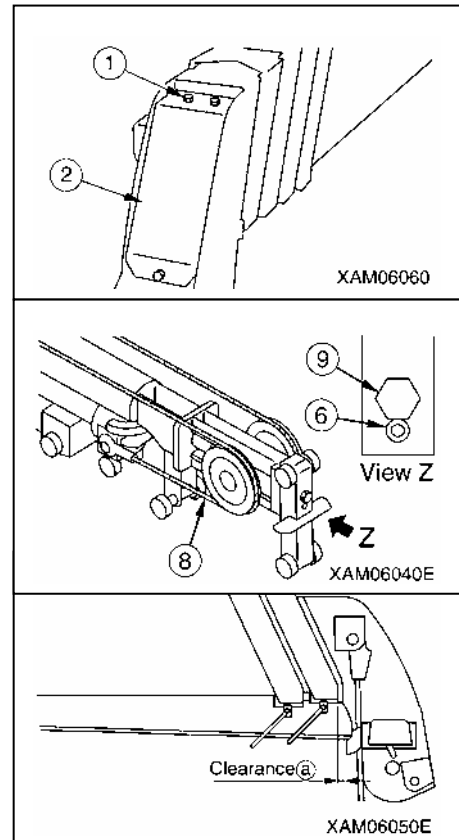

## [ADJUSTMENT OF BOOM TELESCOPING WIRE ROPE]

### CAUTION

The wire ropes must be adjusted to the correct tightness.

A boom extending wire rope (1 piece) and retracting wire rope (1 piece) are used in this machine. Adjustment of these wire ropes must conform to the specified procedure. Use the following procedure for wire rope adjustment.

1. With the booms retracted in a horizontal position, extend the telescoping booms approx. 2m.

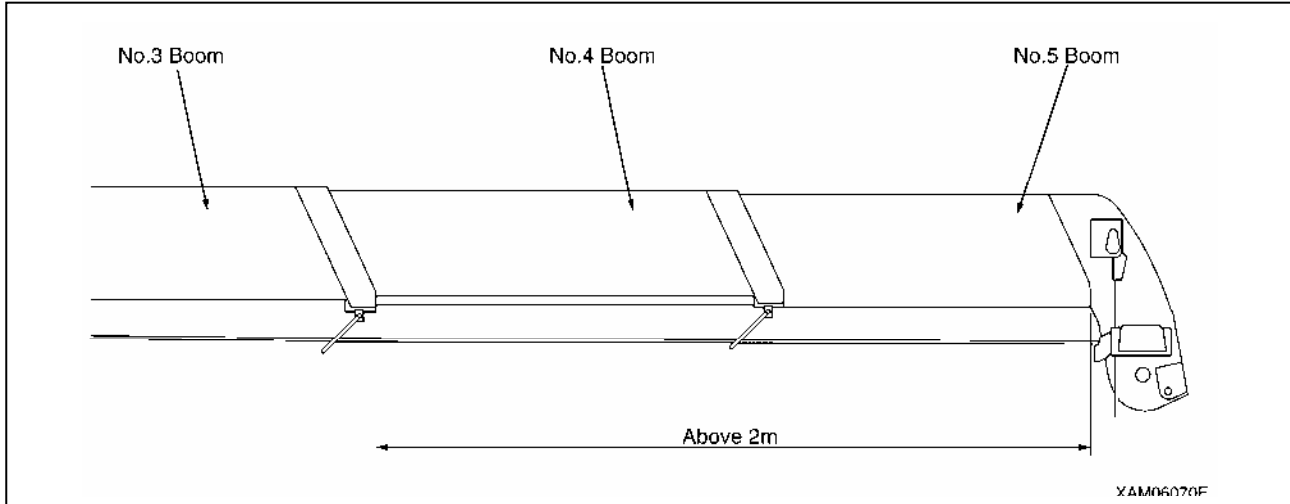

2. Retract the booms completely. Slow boom retraction is required. Measure clearance (a) to check the following for proper adjustment.

- If 5mm or more clearance is formed, adjust the retracting wire rope (5) of boom No.5.
- If no clearance is formed, perform wire rope adjustment from section 5 "Adjustment of boom No.5 extending wire rope (8)".

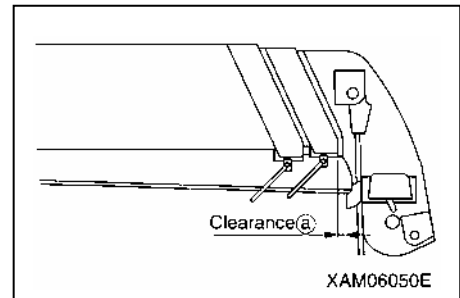

3. Remove the three mounting bolts (1) at the boom end and remove the cover (2).

If sag is developed in the wire rope, adjust the wire rope according to "Adjustment of wire rope".

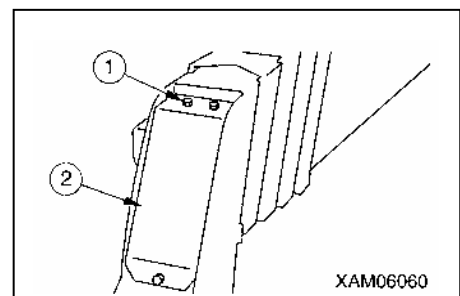

4. Adjustment of boom No.5 retracting wire rope (5)

(1) With the lock nut (3) loose, turn the adjusting nut (4) in the direction that the retracting wire rope (5) becomes tight (clockwise) to provide laterally even tightening until clearance (a) is bridged.

(2) If the retracting wire rope remains sagging or 5mm or more clearance remains present after performing steps 1 and 2, readjustment is required.

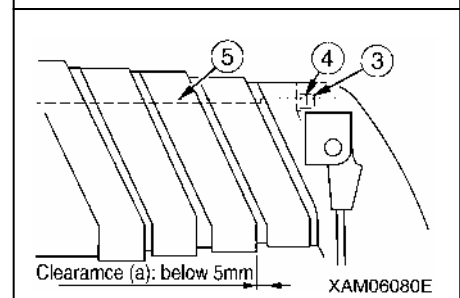

5. Adjustment of boom No.5 extending wire rope (8)

- (1) Remove the lock bolt (6). Turn the adjusting bolt (9) in the direction that the extending wire rope (8) of boom No.5 becomes tight (clockwise) to provide tightening to the verge of the extension of boom No.5.
- (2) Provide retightening to both adjusting nuts (4) of the boom No.5 retracting wire rope (5) two turns each.
- (3) Secure the adjusting nuts (4) of the boom No.5 retracting wire rope (5) with the lock nut (3).
- (4) Provide retightening to both adjusting bolt (9) of the boom No.5 extending wire rope (8), and secure it with the lock bolt (6).

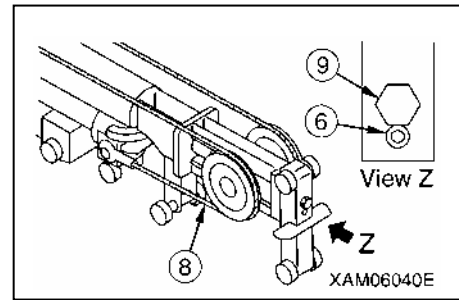

6. Install the cover (2) to the boom end with the three mounting bolts (1) upon completion of adjustment.



## 8.6 MAINTENANCE EVERY 30 HOURS

### [1] CHECKING / CLEANING AIR CLEANER ELEMENT

#### WARNING

- Do not clean and replace the air cleaner when the engine is in rotation. Potential damage to the engine may occur if disregarded.
- Use of compressed air when cleaning the element causes particles to be airborne. Always wear protective goggles to prevent injury from flying particles.

#### CAUTION

- Perform the cleaning of the air cleaner every 20 to 30 hours. Assure pre- or post-work cleaning when using the machine in a dusty site.
- Do not tap and bump the element against anywhere when cleaning it.
- Avoid the use of an element if its groove, gasket, or sealing is damaged.
- Be sure to replace the element with a new one after 5 cleanings or a lapse of 1 year from initial use.
- Always use Maeda genuine elements.

1. See "Operation 1.9 Engine Hood" and open the engine hood.
2. Disengage the two clamps (1) and remove the dust pan (2).

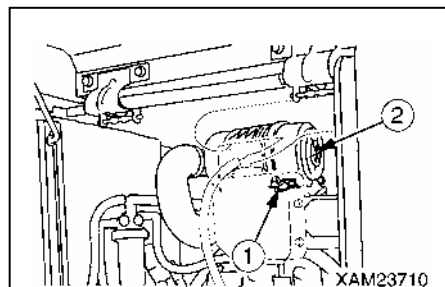

3. Pull out the element (3).
4. Cover the duct entrance located at the back of the air cleaner body (4) with a clean cloth or tape, to keep impurities out of the duct entrance.
5. Clean the inside of the air cleaner body (4).

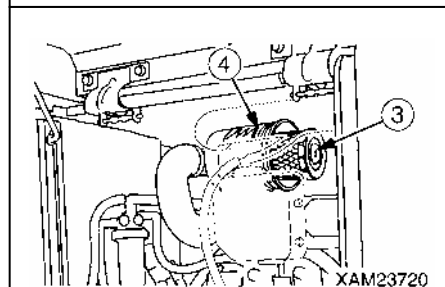

6. Blow dry compressed air on the inside of the element along the grooves at {max. 0.69MPa (7kg/cm<sup>2</sup>)}.  
Blow compressed air on the outside of the element along the grooves, and re-blow the air on the inside.

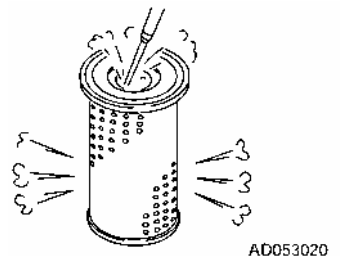

#### NOTES

Always replace the element with a new one after 5 cleanings or a lapse of 1 year from initial use.

7. Shine a light bulb into the element after cleaning for check. If check finds a pore or thinned part, replace the element.

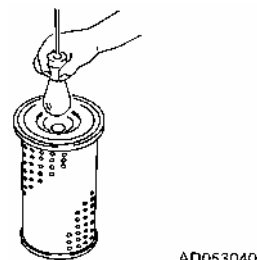

8. Clean the inside of the dust pan (2) and rubber cup (5).

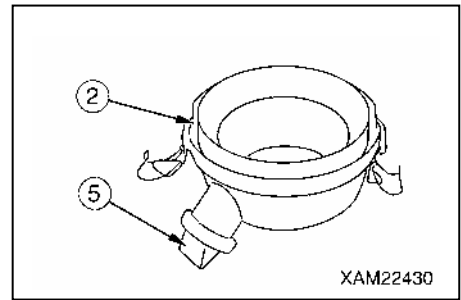

9. Remove the cloth or tape from the air connector at the back of the air cleaner body (4).

10. Insert the cleaned element (3) into the air cleaner body (4).

11. Install the dust pan (2) to the air cleaner body (4) with a "TOP" mark faced upward, and secure it with the two clamps (1).

12. See "Operation 1.9 Engine Hood" and close the engine hood.

## 8.7 MAINTENANCE EVERY 50 HOURS

### [1] DRAINING CONTAMINANT WATER/DEPOSITS IN FUEL TANK

#### WARNING

- Keep from heat and flame, including cigarettes.
- Be sure to stop the engine before draining fuel.  
Potential ignition may occur through spilled fuel if disregarded.
- Always put in the fuel tank drain plug and secure it after draining fuel.

- Fuel drain pan: A 1-liter container

1. Place the machine on a level surface.
2. See “Operation 2.14 Outrigger Setting Operation” to rotate the rotary of the “outrigger (3)” and “outrigger (4)” outward.
3. Remove the three mounting bolts (2) and remove the inspection cover (1).
4. Place a drain pan directly under the fuel tank drain plug (P) to receive drained fuel.
5. Remove the drain plug (P) slowly to drain fuel, keeping from contact with draining fuel.

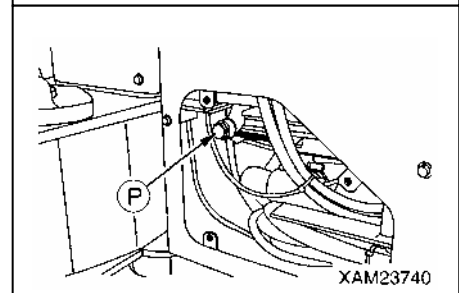
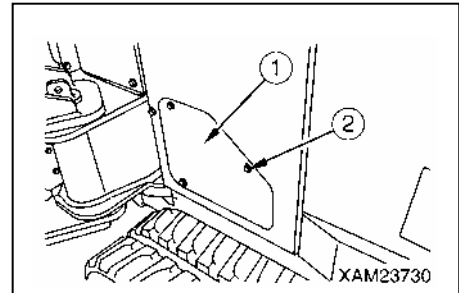

| NOTES   |
|---|
| Remove the fuel tank cap (F) if normal or smooth fuel draining fails. |

6. Put in the drain plug (P) and secure it upon completion of draining fuel.

| NOTES                                |
|--------------------------------------|
| Wipe off fuel completely if spilled. |

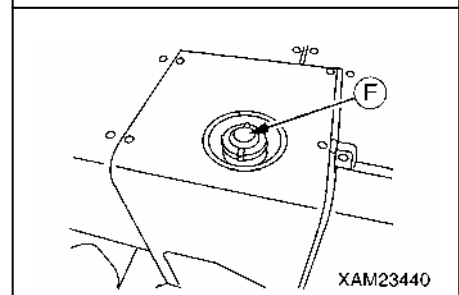

7. Install the inspection cover (1), and secure it with the three mounting bolts (2).
8. See “Operation 2.24 Outrigger Stowing Operation” to stow the outriggers.

## [2] DRAINING CONTAMINANT WATER/DEPOSITS IN WATER SEPARATOR

### **⚠ WARNING**

- The water separator pot has fuel (diesel oil) inside. Be extremely careful of fire such as cigarette when cleaning the water separator pot.
- If the fuel spills when the water separator pot is removed, thoroughly wipe it off.

### **CAUTION**

Water or dust accumulated inside the water separator pot will cause engine failure. Check inside the pot and remove any water or dust accumulated inside.

1. Place the machine on a level surface.
2. See “Operation 1.9 Engine Hood” and open the engine hood.
3. Set the fuel lever (3) on the water separator pot (1) to a horizontal position (Close position) to stop fuel supply.
4. Turn the retaining ring (4) counterclockwise to loosen it, and remove the water separator pot (1).
5. Clean the inside of the pot (1) and element with light oil. Blow dry compressed air on the inside of the pot at (0.20 to 0.29MPa {2 to 3kg/cm<sup>2</sup>}) to remove impurities from the internal surface.
6. Put the pot (1) in place, and turn the retaining ring (4) clockwise to tighten it.
7. Set the fuel lever (3) to a vertical position (Open position).

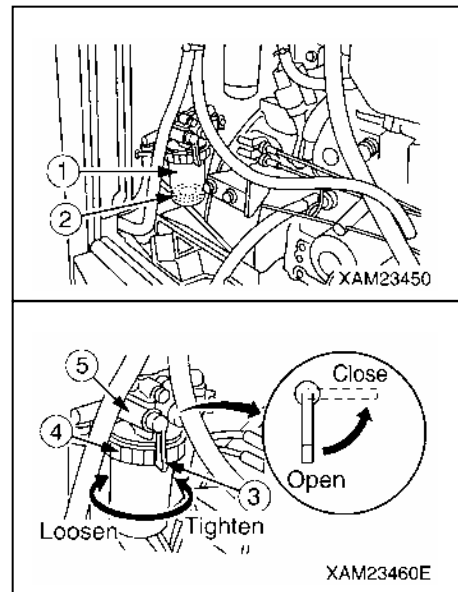

### **NOTES**

Wipe off fuel completely if spilled.

8. Use the following procedure for air bleed of the fuel system.
  - (1) Turn ON the starter switch to supply fuel, and wait until the pot (1) is filled up.
  - (2) Upon fill-up of the pot (1), turn OFF the starter switch.

### **NOTES**

Ensure that a red float (2) in the pot remains on the bottom. If the red float (2) is raised, water is present in fuel.

9. See “Operation 1.9 Engine Hood” and close the engine hood.

### [3] GREASING MACHINE UNITS

## CAUTION

- Grease type varies with greasing points. Failure to grease properly may cause the machine to shorten its useful life. See the following table for grease types.
- Greasing a new machine is required once every 10 hours until the machine attains the first 100 hours of operation that initial fit emerges.

- Use proper grease specified below according to the greasing points.

| №  | Greasing point  | 1 place   | Grease type       |
|----|---|-----------|-------------------|
| 1  | Greasing of the boom mounting pin                                       | 1 place   | Lithium grease    |
| 2  | Greasing of the derricking cylinder bottom mounting pin                 | 1 place   |                   |
| 3  | Greasing of the derricking cylinder rod mounting pin                    | 1 place   |                   |
| 4  | Greasing of the outrigger rotary shaft                                  | 4 places  |                   |
| 5  | Greasing of the mounting pin of the outrigger grounding cylinder bottom | 4 places  |                   |
| 6  | Greasing of the mounting pin of the outrigger grounding cylinder rod    | 4 places  |                   |
| 7  | Greasing of the slewing gear  | 1 place   |                   |
| 8  | Greasing of the hook block  | 1 place   | Molybdenum grease |
| 9  | Greasing of the boom slide plate  | 8 places  |                   |
| 10 | Greasing of both sides and bottom of a boom                             | Each boom | Rope oil          |
| 11 | Greasing of the boom telescoping wire rope                              | 2 pieces  |                   |
| 12 | Greasing of the winch wire rope   | 1 piece   |                   |

1. With the use of the grease gun, grease the greasing points (No.1 to 9) specified in the above table through corresponding grease plugs. (See the following page)
2. Wipe off old grease squeezed out after greasing.
3. Place the outriggers when greasing the outrigger cylinders.
4. Place the boom derricking lever in the “Raise” position (pull it toward you) to raise the boom slightly for greasing the derricking cylinder mounting pin and slide plate that is located on top of the boom.
5. Place the boom telescoping lever in the “Extend” position (push it toward the front) to extend the boom for greasing both sides and bottom of the boom and wire rope.
6. Apply red rope grease to prevent wire rope abrasion and rust formation.  
With the rope surface cleaned, grease the rope with a brush.

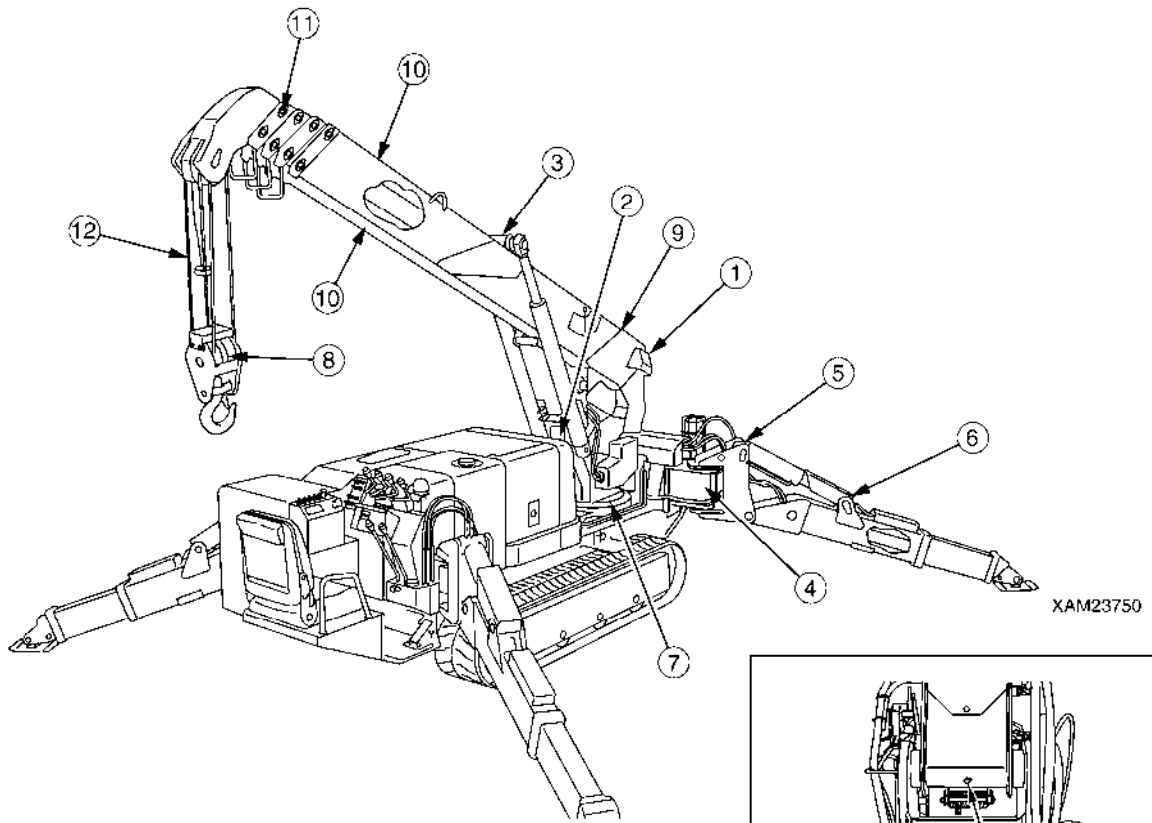

XAM23750

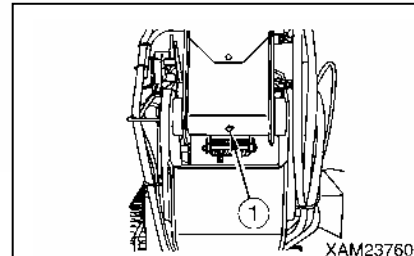

XAM23760

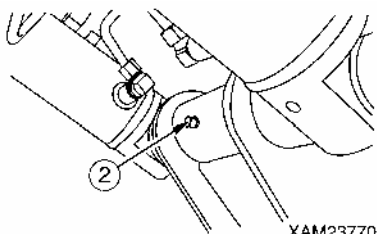

XAM23770

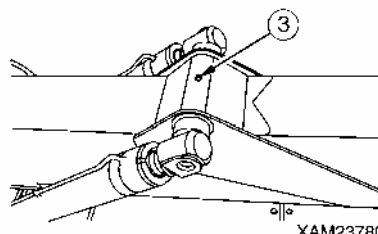

XAM23780

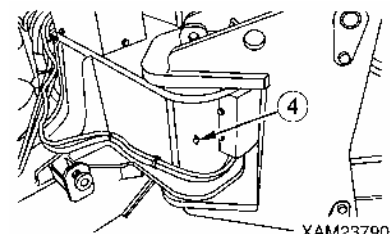

XAM23790

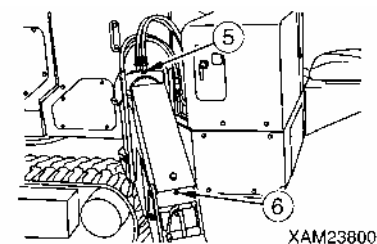

XAM23800

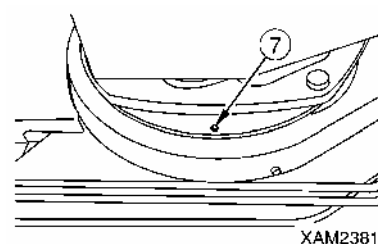

XAM23810

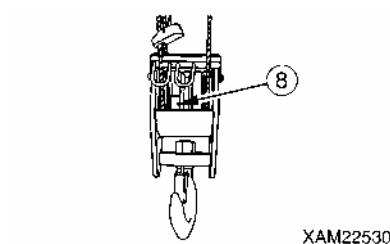

XAM22530

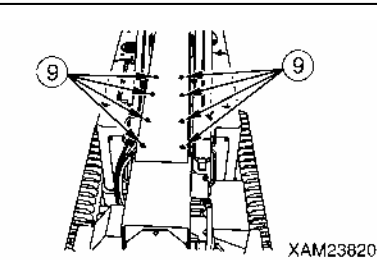

XAM23820

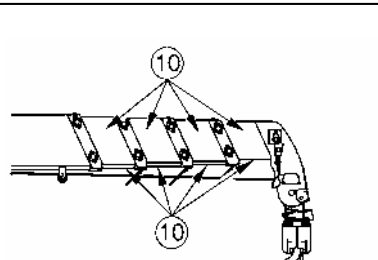

XAM06210

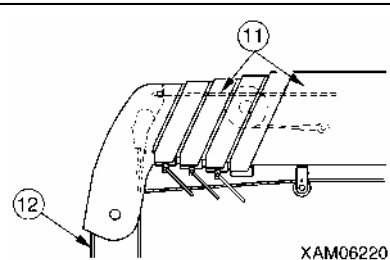

XAM06220

## 8.8 MAINTENANCE EVERY 250 HOURS

Perform this maintenance in tandem with maintenance every 30/50 hours.

### [1] REPLACEMENT ENGINE LUBRICATING OIL AND OIL FILTER CARTRIDGE

#### **⚠ WARNING**

- The drain plug of the engine oil pan is located directly underneath the machine. Place the outriggers and raise the machine 50mm from the ground for draining engine oil. Insert square timbers between both rubber track and the ground to gain stability for safety assurance.
- Make sure the oil level gauge is secured properly after inspection and replenishment of the oil. Potential fall of the oil level gauge during operation may occur if disregarded, which could cause boiling oil to gush that results in burns.
- All the parts will be at elevated temperatures immediately after engine operation, which urges you not to replace oil and the filter cartridge. Always perform replacement with the engine cold to touch.

#### **CAUTION**

- Ensure that no old gasket adheres to the filter stand. Potential oil leak may occur if old gasket remains on the stand.
- Be sure to use oil specified in section 5.1 “Use of Lubricating Oil according to Temperatures” in Inspection and Maintenance. Failure to use proper oil may cause the engine to shorten its useful life. Always use the specified oil for replenishment.
- The engine oil must be maintained at a proper amount.
- The complete draining of oil is disabled if the engine becomes cold completely. Oil draining is allowed when the engine is cold to touch.
- Keep impurities out of the filler cap when replenishing oil.

- Oil drain pan: An 8-liter container
  - Quantity of oil for replacement: 3.1L
1. Place the machine on a level surface.
  2. See “Operation 2.14 Outrigger Setting Operation” to set the outriggers and raise the rubber track for about 50mm from the ground.

#### **⚠ WARNING**

Check the following before crawling under the machine:

- Ensure that the outriggers are extended at the maximum.
- Visually check the level to make sure the machine in a horizontal position.
- Insert solid blocks between the crawler and the ground to keep the machine raised.

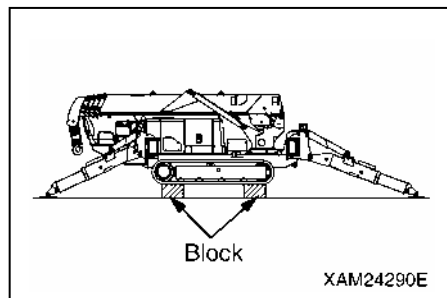

3. Crawl under the machine and place a drain pan directly underneath the drain plug (P) at the bottom of the engine oil pan to receive drained oil.

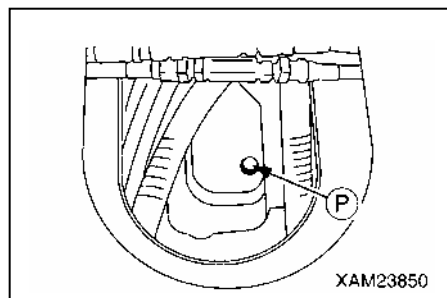

4. See "Operation 1.9 Engine Hood" and open the engine hood.
5. Remove the drain plug (P) slowly to drain the oil, keeping from contact with draining oil.
6. Check the drained oil. If check finds a considerable amount of metal powder and foreign objects, contact our sales service agency.
7. Put in the drain plug (P) and secure it.
8. See "Operation 2.24 Outrigger Stowing Operation" to stow the outriggers and lower the machine on the ground.
9. Turn the filter cartridge (3) counterclockwise with the use of the filter wrench to remove it.

### NOTES

The oil is to be drained in large quantity immediately after the engine is stopped. Wait for 10 minutes before removing the filter cartridge (3).

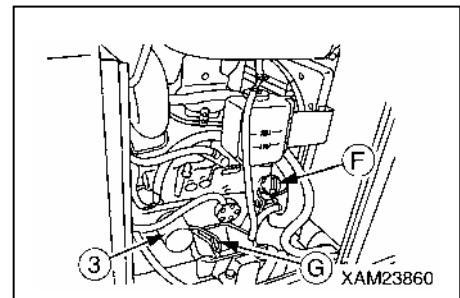

10. Clean the filter stand. Apply clean engine oil (or a light coating of grease) to a new filter cartridge gasket and thread part, and install the filter cartridge.

### NOTES

With the gasket surface maintained contact with the sealing surface of the filter stand, rotate the filter cartridge one-half to three-quarters of a turn to secure it. Always give manual tightening to the filter cartridge.

11. Check around the filter cartridge (3) for oil leaks. Be sure to wipe off oil completely if spilled.
12. After replacing the filter cartridge (3), supply the engine oil at a specified amount from the filler cap (F).
13. With the oil level gauge (G) pulled out, wipe off the oil with a waste cloth.
14. With the oil level gauge (G) inserted in the gauge guide, pull the oil level gauge out.
15. Make sure the oil level is in the range "H" to "L" marked on the oil level gauge (G).
16. Attach the oil level gauge (G) and filler cap (F) properly upon completion of oil replacement.
17. Start the engine, and idle it for 5 minutes. Stop the engine.
18. Make sure again the oil level is in the range "H" to "L" marked on the oil level gauge (G).
19. See "Operation 1.9 Engine Hood" and close the engine hood.

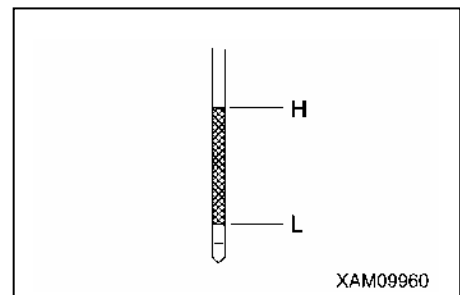



## [2] CHECKING/ADJUSTING ALTERNATOR BELT TENSION

### [TENSION CHECK]

1. See "1.9 Engine Hood" in the Operation and open the engine hood.
2. With the fingers, push (by approximately 98 N {10kgf}) the midpoint between the fan pulley (2) and alternator pulley (1) of the belt (3), and if the strain is between 10 and 12mm it is within standard.
3. If the inspection result indicated that the strain of the belt (3) is out of the standard value range, see the Tension check section and adjust the tension of the belt (3).

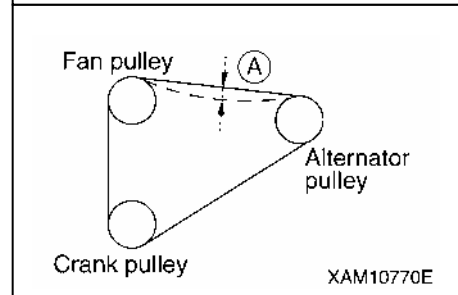
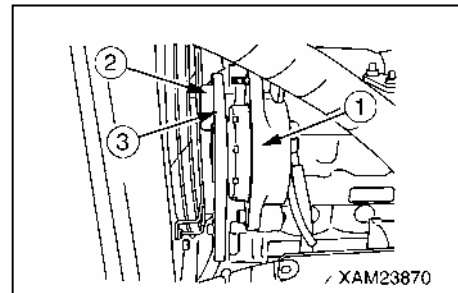

### NOTES

Inspect the followings as well when you inspect the tension of the alternator belt.

- Check the pulleys for breakage, the V groove and belt for wear. Ensure that the belt is not in contact with the bottom of the V groove.
- Prompt belt replacement is required if belt adjustment is no longer enabled due to a stretched belt or if the belt is scratched or cracked.
- At least 5 minute long test run is required after belt replacement. Re-adjust the belt tension upon completion of test run.

### [TENSION ADJUSTMENT]

- Have a wooden bar available.
1. Insert the bar between the alternator (1) and cylinder block.
  2. Loosen the lower bolt (5) and adjusting bolt (4).
  3. Move the alternator (1) until strain of the belt (3) falls within the standard value range, pulling the bar toward you.
  4. Tighten the alternator lower bolt (5) and then the adjusting bolt (4) to secure the alternator (1).
  5. See "Operation 1.9 Engine Hood" and close the engine hood.

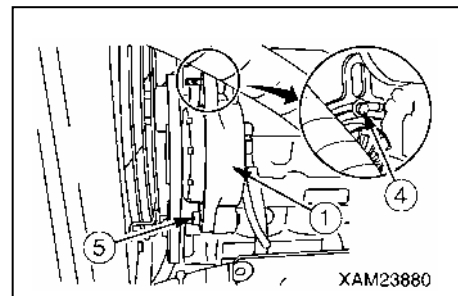

### [3] CHECKING / REFILLING OIL IN TRAVELING MOTOR REDUCTION GEAR CASE

#### CAUTION

- See “Maintenance 5.1 Use of Lubricating Oil According to Temperature” for which oil to be used.
- Use seal tape, etc. at the thread of the filler plug to stop the oil leak and securely tighten the plug after refilling with the oil.

1. Move the machine forward and backward to position it immediately above the drain plug (P) of the traveling motor reduction gear case.

#### NOTES

This machine is equipped with two drain plugs (P). Either drain plug must be positioned directly underneath the machine.

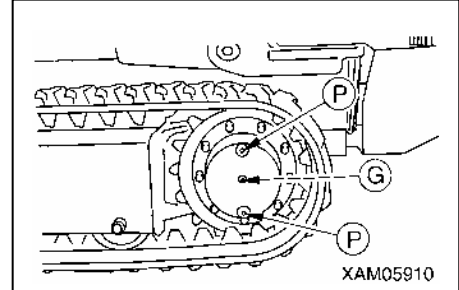

2. Remove the oil inspection plug (G) of the traveling motor reduction gear case, and make sure oil is drained from the plug hole.
3. In the case of insufficient oil in the casing, remove the top drain plug (P) and replenish gear oil through the plug hole.

#### NOTES

- Replenish the gear oil until it exudes from the oil inspection plug.
- Wipe off the oil completely if spilled.

4. Put in the top drain plug (P) and oil inspection plug (G), and secure the plugs upon completion of oil inspection and replenishment.

## 8.9 MAINTENANCE EVERY 500 HOURS

Perform this maintenance in tandem with maintenance every 30/50/250 hours.

### [1] REPLACEMENT FUEL FILTER CARTRIDGE

#### **⚠ WARNING**

- **Keep from heat and flame, including cigarettes, when replacing the fuel filter element.**
- **All the parts will be at elevated temperatures immediately after engine operation, which urges you not to replace the fuel filter element. Always perform replacement with the engine cold to touch.**

1. Place the machine on a level surface.
2. See “Operation 1.9 Engine Hood” and open the engine hood.
3. Raise the lever (2) of the head (4) section to horizontal position (close) to shut off the fuel.
4. Turn the retainer ring (3) of the head (4) section counterclockwise to loosen, then remove the pot (1) from the head (4) section.
5. Drain the fuel and water out of the pot (1).
6. Clean the pot (1) and element with diesel, and spray the compressed air (0.20 to 0.29 MPa {2 to 3 kg/cm<sup>2</sup>}) inside to scrape off the dusts from the surface.
7. Set the pot (1) to the head (4) section, then turn the retainer ring (3) clockwise to tighten.
8. Lower the fuel lever (2) of the head (4) section down to the vertical position (open) to open the fuel circuit.
9. See “Operation 1.9 Engine Hood” and close the engine hood.

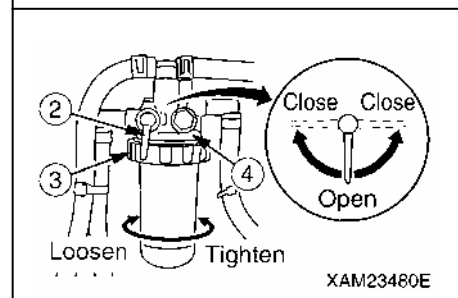
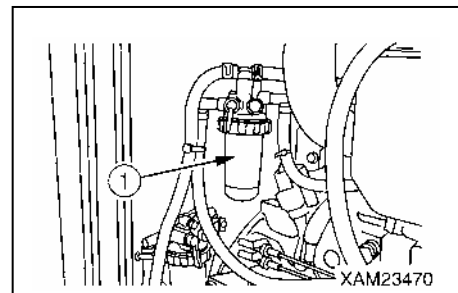

## [2] REPLACEMENT HYDRAULIC OIL RETURN FILTER CARTRIDGE

### ⚠ WARNING

- All the parts will be at elevated temperatures immediately after engine operation, which urges you not to replace the filter. Always perform replacement with the engine cold.
- Potential gush of oil may occur upon removing the filler cap of the hydraulic oil tank. Be sure to relieve internal pressure by slowly rotating the filler cap before cap removal.
- Make sure the filler cap is closed properly after replenishment of the oil. Potential fall of the filler cap during operation may occur if disregarded, which could cause boiling oil to gush that results in burns.

### CAUTION

- See “Maintenance 5.1 Use of Lubricating Oil According to Temperature” for which oil to be used.
- Place the machine in travel position for oil quantity inspection. Oil quantity inspection with the machine in working position may deceive your eyes to deem the quantity of oil low. Owing to improper judgment, the oil may be supplied at an excessive amount.
- The engine must be at halt until piping and hydraulic equipment is filled with oil after replacement of the hydraulic oil filter.
- Oil replenished should remain below “H” (upper limit) on the level gauge. Excessive oil replenishment may cause the oil to gush from the air breather during machine traveling and crane operation, which could result in burns.
- Keep impurities out of the filler cap when replenishing oil.

1. Place the machine on a level surface.
2. See “Operation 2.14 Outrigger Setting Operation” to rotate the rotary of the “outrigger (1)” and “outrigger (2)” outward.
3. Remove the six mounting bolts (2) and remove the cover (1).
4. Turn the filter cartridge (3) counterclockwise with the use of the filter wrench to remove it.
5. Clean the filter stand. Apply clean engine oil (or a light coating of grease) to the gasket and thread part of a new filter cartridge (3), and attach the filter cartridge.

### NOTES

With the gasket surface maintained contact with the sealing surface of the filter stand, rotate the filter cartridge one-half to three-quarters of a turn to secure it. Always give manual tightening to the filter cartridge.

6. Check around the filter cartridge (3) for oil leaks. Be sure to wipe off oil completely if spilled.
7. See “Operation 2.1.2 Checking Before Operation” to check the oil level in the hydraulic oil tank. Prompt oil refilling is required if check finds insufficient oil.
8. Install the inspection cover (1), and secure it with the six mounting bolts (2).
9. See “Operation 2.24 Outrigger Stowing Operation” to stow the outriggers.

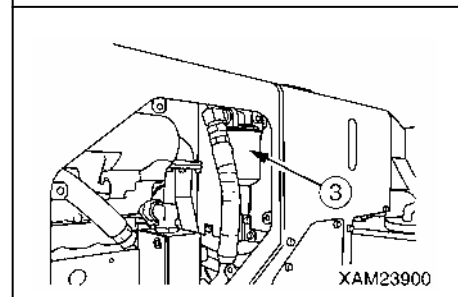
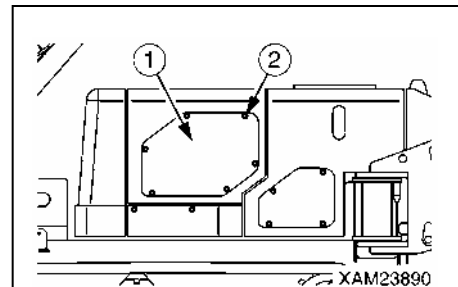

### [3] REPLACEMENT HYDRAULIC OIL SUCTION FILTER

#### ⚠ WARNING

- All the parts will be at elevated temperatures immediately after engine operation, which urges you not to replace the filter. Always perform replacement with the engine cold.
- Potential gush of oil may occur upon removing the filler cap of the hydraulic oil tank. Be sure to relieve internal pressure by slowly rotating the filler cap before cap removal.
- Make sure the filler cap is closed properly after replenishment of the oil. Potential fall of the filler cap during operation may occur if disregarded, which could cause boiling oil to gush that results in burns.

#### CAUTION

- See “Maintenance 5.1 Use of Lubricating Oil According to Temperature” for which oil to be used.
- Place the machine in travel position for oil quantity inspection. Oil quantity inspection with the machine in working position may deceive your eyes to deem the quantity of oil low. Owing to improper judgment, the oil may be supplied at an excessive amount.
- The engine must be at halt until piping and hydraulic equipment is filled with oil after replacement of the hydraulic oil filter.
- Oil replenished should remain below “H” (upper limit) on the level gauge. Excessive oil replenishment may cause the oil to gush from the air breather during machine traveling and crane operation, which could result in burns.
- Keep impurities out of the filler cap when replenishing oil.

1. Place the machine on a level surface.
2. See “Operation 2.14 Outrigger Setting Operation” to rotate the rotary of the all outriggers outward.

#### NOTES

Raise the machine slightly with the outriggers placed.

3. See “Operation 2.19 Boom Derricking Operation” to raise the boom to a position where facilitated work is assured, and stop the engine.
4. Remove the three mounting bolts (2) and remove the inspection cover (1).
5. Remove the eight mounting bolts (4) and remove the flange (3) on top of the hydraulic oil tank.
6. Remove the flange (3) and pull out the suction filter (5) from inside the hydraulic oil tank.
7. Insert the new suction filter (5) to the inside of the hydraulic oil tank.
8. Put the flange (3) in place with liquid packing applied to the rubber plate (6). Secure the flange (3) with the eight mounting bolts (4).

#### NOTES

Wipe off the oil completely if spilled.

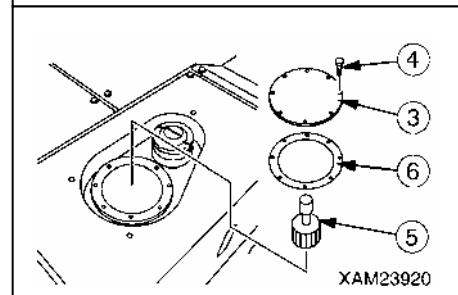
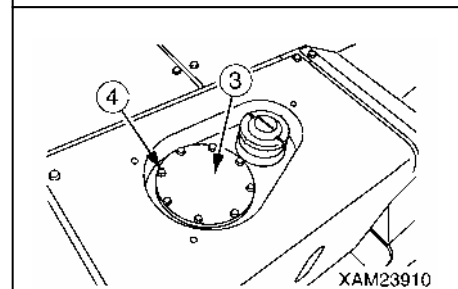
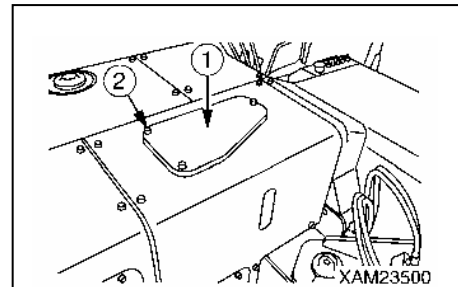

9. See “Operation 2.1.2 Checking Before Operation” to check the oil level in the hydraulic oil tank.

Prompt oil refilling is required if check finds insufficient oil.

10. Install the inspection cover (1), and secure it with the three mounting bolts (2).

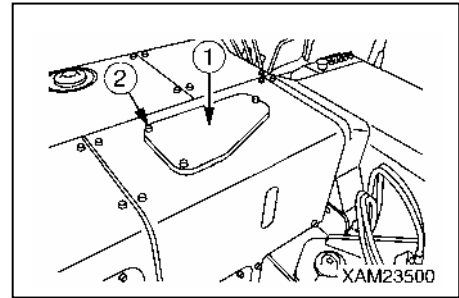

11. See “Operation 2.19 Boom Derricking Operation” to lower the boom completely, and stop the engine.

12. Use the following procedure for air bleed.

(1) Start the engine with piping and hydraulic equipment filled with oil.

Make sure the engine runs at low idle for 10 minutes.

(2) Move the cylinders and winch motor slowly with a crane control lever at low idle speed.

Always stop the boom derricking cylinder and telescoping cylinder approx. 100mm back from the stroke end when operating the cylinders.

Repeat this task 4 to 5 times.

(3) Allow all the outriggers to be extended, referring to “Operation 2.14 Outrigger Setting Operation”.

Extend and retract the outrigger cylinder, keeping the machine down on the ground.

Always stop the outrigger cylinder approx. 100mm back from the stroke end when operating the cylinder.

Repeat this task 4 to 5 times.

13. See “Operation 2.24 Outrigger Stowing Operation” to stow the outriggers.

## 8.10 MAINTENANCE EVERY 1000 HOURS

Perform this maintenance in tandem with maintenance every 30/50/250/500 hours.

### [1] REPLACEMENT AIR CLEANER ELEMENT

#### **⚠ WARNING**

Do not clean and replace the air cleaner when the engine is in rotation.  
Potential damage to the engine may occur if disregarded.

#### **CAUTION**

- Avoid the use of an element if its groove, gasket, or sealing is damaged.
- Be sure to replace the element with a new one after 5 cleanings or a lapse of 1 year from initial use.
- Always use Maeda genuine elements.

1. Place the machine on a level surface.
2. See "Operation 1.9 Engine Hood" and open the engine hood.
3. Disengage the two clamps (1) and remove the dust pan (2).
4. Pull out the element (3).
5. Cover the duct entrance located at the back of the air cleaner body (4) with a clean cloth or tape, to keep impurities out of the duct entrance.
6. Clean the inside of the air cleaner body (4).
7. Clean the inside of the dust pan (2) and rubber cup (5).
8. Remove the cloth or tape from the air connector at the back of the air cleaner body (4).
9. Insert a new element (3) into the air cleaner body (4).
10. Install the dust pan (2) to the air cleaner body (4) with a "TOP" mark faced upward, and secure it with the two clamps (1).
11. See "Operation 1.9 Engine Hood" and close the engine hood.

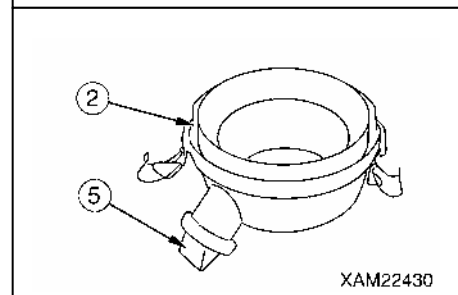
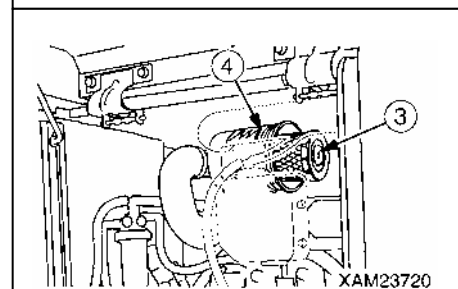
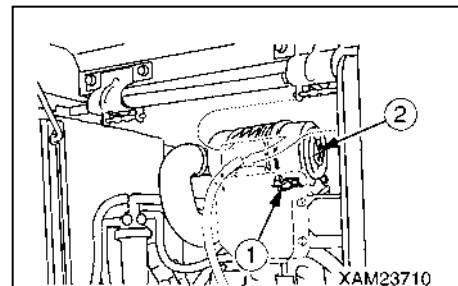

## [2] CLEANING ENGINE COOLING SYSTEM

### ⚠ WARNING

- Coolant will be at elevated temperatures immediately after engine operation, which urges you not to drain coolant. Always perform coolant draining with the engine cold.
- Do not remove the radiator cap if radiator coolant is hot. Potential gush of boiling water may occur if disregarded. Cap removal is allowed when the water drops in temperature. Be sure to relieve internal pressure by slowly rotating the filler cap before cap removal.
- Do not stand in front of and behind the machine when starting the engine for cooling system cleaning. Failure to stand aside of the machine may pose a danger in the event of a sudden movement of the machine.
- Keep antifreeze from flame. Antifreeze is a flammable solution. Do not smoke when handling antifreeze.

### CAUTION

- Always use tap water for coolant. Contact us or our sales service agency if river water, well water, or water through the small water-supply system is necessarily substituted for tap water.
- A mixing ratio of antifreeze is to be controlled by the concentration meter.

Cooling system cleaning and antifreeze replacement should conform to the cycles specified in the following table.

| Antifreeze type                | Cooling system cleaning and antifreeze replacement |
|--------------------------------|--|
| Anti-corrosive all-season type | Annually or every 1000 hours                       |

Perform cooling system cleaning and antifreeze replacement with the machine in a horizontal position. A mixing ratio of antifreeze varies with temperature. Antifreeze as a volume ratio is min. 30% to yield anticorrosive effect.

The mixing ratio between water and antifreeze is to be determined with respect to past minimum temperatures, in accordance with “Mixing ratio between water and antifreeze” shown below. For actual mixing, set temperature 10 degrees lower than minimum temperature.

### [MIXING RATIO BETWEEN WATER AND ANTIFREEZE]

| Min. temperature (°C)<br>Mixed quantity (L) | Min. -15   | -20 | -25 |
|---|------------|-----|-----|
|   | Antifreeze | 1.4 | 1.5 |
| Water                                       | 3.1        | 3.0 | 2.5 |

- Antifreeze-mixed water drain pan: A 6-liter container
- Have a water filling hose available.

1. Place the machine on a level surface.
2. See “Operation 2.14 Outrigger Setting Operation” to rotate the rotary of the “outrigger (1)” and “outrigger (4)” outward.
3. Remove the two mounting bolts (4) and remove the radiator top cover (3).

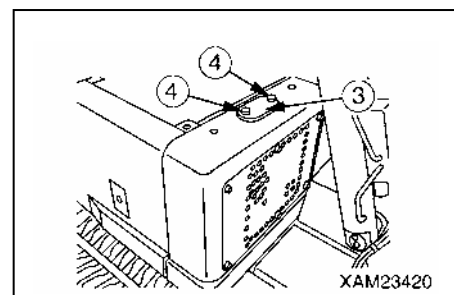



4. Turn the radiator cap (5) slowly until it comes into contact with the stopper to relieve internal pressure from the radiator.

5. With no pressure in the radiator, give further turning of the radiator cap (5) until it reaches the stopper while holding it down. Remove the radiator cap (5).

6. See "Operation 1.9 Engine Hood" and open the engine hood.

7. Remove the four mounting bolts (7) and remove the engine hood bottom cover (6).

8. Place a drain pan under the drain valve (8) lying below the radiator to receive coolant (antifreeze-mixed water).

9. Open the drain valve (8) to drain coolant.  
Close the drain valve (8) upon completion of draining.

10. Supply tap water to the radiator through the radiator supply port.  
The radiator needs to be filled up to the supply port.

11. Start the engine with the drain valve (8) open, and ensure the engine runs at low idle. Conduct a 10-minute cleaning with running water.

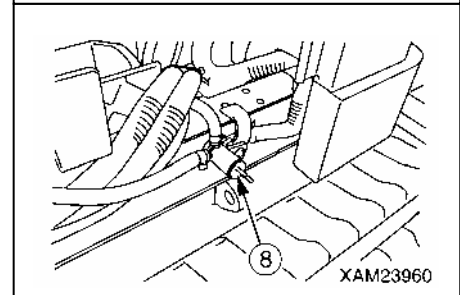
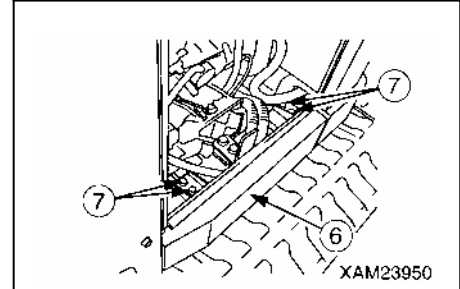
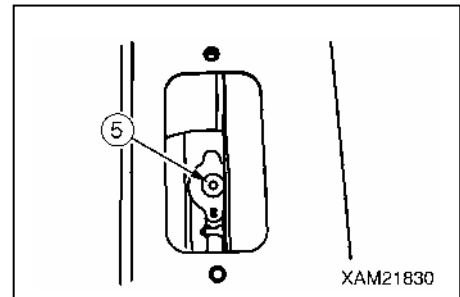

### CAUTION

- The radiator is to retain a high water level during cleaning with running water. Adjust the quantities of water supplied and drained as necessary.
- Ensure that the water filling hose stays connected to the radiator supply port properly during cleaning with running water.

12. After cleaning, stop the engine and water supply and drain tap water. Close the drain valve (8) upon completion of draining.

### NOTES

Cleaning with the cleaning agent must conform to instructions provided on the cleaning agent.

14. Open the drain valve (8) to drain the cleaning agent after cleaning with the agent. Close the drain valve (8) upon completion of draining.

15. Supply tap water to the radiator through the radiator supply port.  
The radiator needs to be filled up to the supply port.

16. Start the engine with the drain valve (8) open, and ensure the engine runs at low idle. Conduct a cleaning with running water until clean water flows out of the radiator.

### CAUTION

- The radiator is to retain a high water level during cleaning with running water. Adjust the quantities of water supplied and drained as necessary.
- Ensure that the water filling hose stays connected to the radiator supply port properly during cleaning with running water.

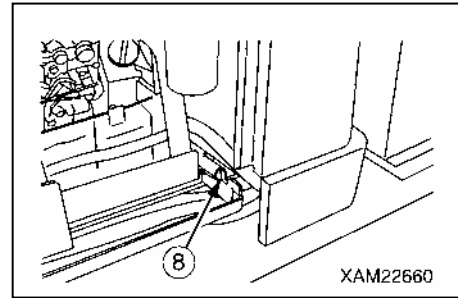

17. Once clean water has out flowed, stop the engine and water supply and drain tap water. Close the drain valve (8) upon completion of draining.

18. Supply coolant mixed of antifreeze and tap water to the radiator through the radiator supply port. The radiator needs to be filled up to the supply port.

### NOTES

See the above-mentioned table, "Mixing ratio between water and antifreeze", for the mixing ratio of antifreeze and tap water.

19. Start the engine with the radiator cap (5) removed, and ensure the engine runs at low idle for 5 minutes. Release air from the cooling system with the engine at high idle for 5 minutes.

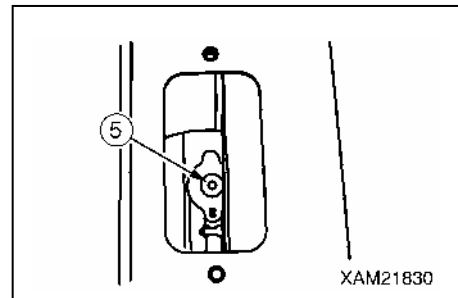

20. Wait for 3 minutes after stopping the engine. Supply tap water to the radiator through the radiator supply port, up to the supply port. Close the radiator cap (5).

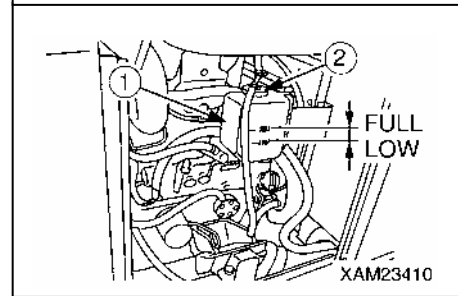

21. Remove the reserve tank (1). Clean the inside of the reserve tank with coolant drained from the tank.

22. Put the reserve tank (1) in place, supply tap water through the supply port to "FULL". Install the cap (2) properly.

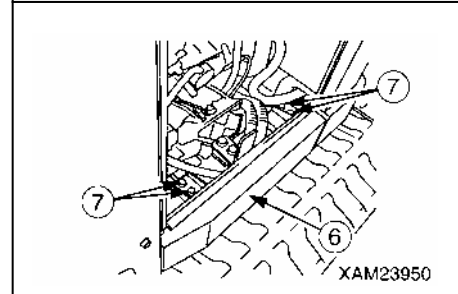

23. Install the engine hood bottom cover (6), and secure it with the four mounting bolts (7).

24. See "Operation 1.9 Engine Hood" and close the engine hood.

25. Install the radiator top cover (3), and secure it with the two mounting bolts (4).

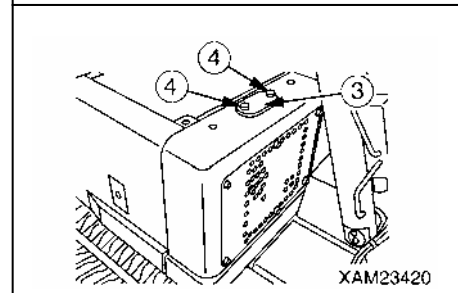

26. See "Operation 2.24 Outrigger Stowing Operation" to stow the outriggers.

### [3] OIL REPLACEMENT IN HYDRAULIC OIL TANK

#### **⚠ WARNING**

- All the parts will be at elevated temperatures immediately after engine operation, which urges you not to replace oil. Always perform replacement with the oil cold.
- Potential gush of oil may occur upon removing the filler cap of the hydraulic oil tank. Be sure to relieve internal pressure by slowly rotating the filler cap before cap removal.
- Make sure the filler cap is closed properly after replenishment of the oil. Potential fall of the filler cap during operation may occur if disregarded, which could cause boiling oil to gush that results in burns.

#### **CAUTION**

- See “Maintenance 5.1 Use of Lubricating Oil According to Temperature” for which oil to be used.
- Place the machine in travel position for oil quantity inspection. Oil quantity inspection with the machine in working position may deceive your eyes to deem the quantity of oil low. Owing to improper judgment, the oil may be supplied at excessive amount.
- The engine must be at halt until piping and hydraulic equipment is filled with oil after replacement of the hydraulic oil filter.
- Oil replenished should remain below “H” (upper limit) on the level gauge. Excessive oil replenishment may cause the oil to gush from the air breather during machine traveling and crane operation, which could result in burns.
- Keep impurities out of the filler cap when replenishing oil.

- Oil drain pan: An 70-liter container
- Quantity of oil for replacement: 55L

1. Place the machine on a level surface.
2. See “Operation 2.14 Outrigger Setting Operation” to rotate the rotary of the all outriggers outward.

#### **NOTES**

Raise the machine slightly with the outriggers placed.

3. See “Operation 2.19 Boom Derricking Operation” to raise the boom to a position where facilitated work is assured, and stop the engine.
4. Remove the three mounting bolts (2) and remove the inspection cover (1).
5. Remove the filler cap (F) located on top of the hydraulic oil tank.
6. Remove the four mounting bolts (4) and remove the inspection cover (3).

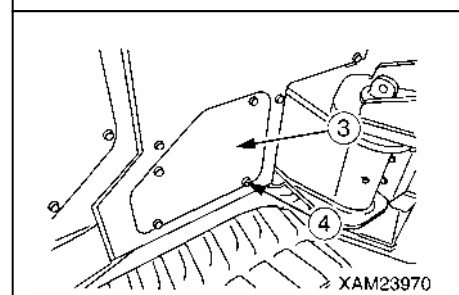
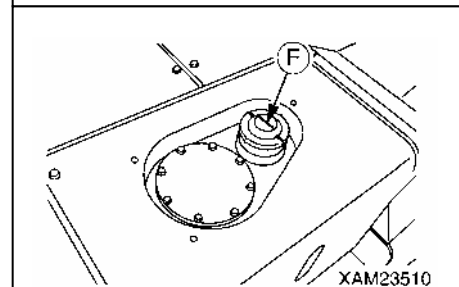
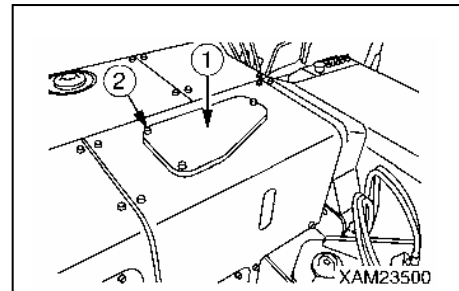

7. Place a drain pan directly underneath the drain plug (P) to receive drained oil.

8. Remove the drain plug (P) slowly to drain the oil, keeping from contact with draining oil.

9. Check the drained oil. If check finds a considerable amount of metal powder and foreign objects, contact our sales service agency

10. Put in the drain plug (P) and secure it.

11. Install the inspection cover (3), and secure it with the four mounting bolts (4).

12. Supply the hydraulic oil to a specified level point from the filler cap (F), visually checking the oil level gauge (G).

13. Close the filler cap (F) after replenishment of the oil.

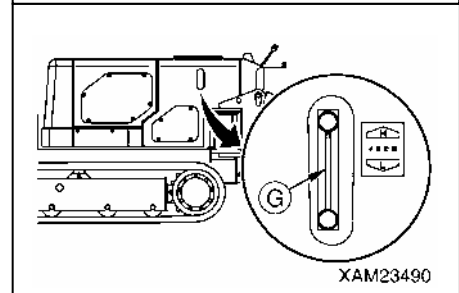
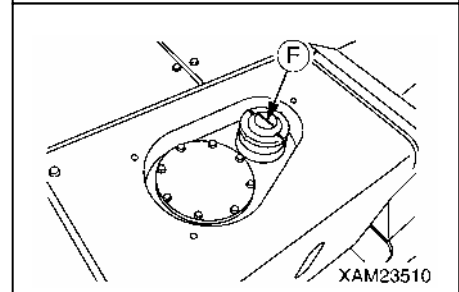
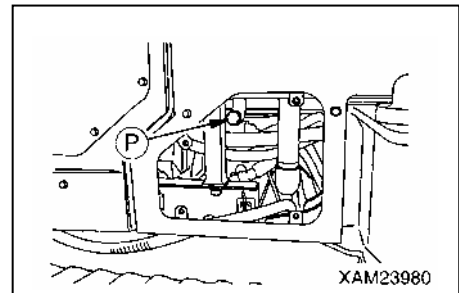

| <b>NOTES</b>                            |
|---|
| Wipe off the oil completely if spilled. |

14. Install the inspection cover (1), and secure it with the three mounting bolts (2).

15. See “Operation 2.19 Boom Derricking Operation” to lower the boom completely, and stop the engine.

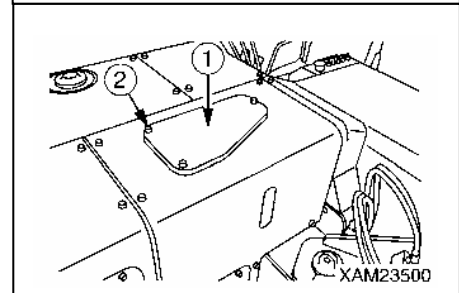

16. Use the following procedure for air bleed.

(1) Start the engine with piping and hydraulic equipment filled with oil.

Make sure the engine runs at low idle for 10 minutes.

(2) Move the cylinders and winch motor slowly with a crane control lever at low idle speed.

Always stop the boom derricking cylinder and telescoping cylinder approx. 100mm back from the stroke end when operating the cylinders.

Repeat this task 4 to 5 times.

(3) Allow all the outriggers to be extended, referring to “Operation 2.14 Outrigger Setting Operation”.

Extend and retract the outrigger cylinder, keeping the machine down on the ground.

Always stop the outrigger cylinder approx. 100mm back from the stroke end when operating the cylinder.

Repeat this task 4 to 5 times.

17. See “Operation 2.24 Outrigger Stowing Operation” to stow the outriggers.

#### [4] OIL REPLACEMENT IN SLEWING REDUCTION GEAR CASE

### ⚠ WARNING

The drain plug of the slewing reduction gear case is located directly underneath the machine. Place the outriggers and raise the machine 50mm from the ground to allow a drain pan to be placed under the machine for draining oil. If the machine becomes unstable and wobbles, insert supports under the front and back of the machine to gain stability.

### CAUTION

- See “Maintenance 5.1 Use of Lubricating Oil According to Temperature” for which oil to be used.
- Use seal tape, etc. at the thread of the filler plug to stop the oil leak and securely tighten the plug after refilling with the oil.

- Oil drain pan: A 1-liter container
- Quantity of oil for replacement: 0.6L

1. Place the machine on a level surface.
2. See “Operation 2.14 Outrigger Setting Operation” to rotate the rotary of the all outriggers outward.

### ⚠ WARNING

Check the following before crawling under the machine:

- Ensure that the outriggers are extended at the maximum.
- Visually check the level to make sure the machine in a horizontal position.
- Insert solid blocks between the crawler and the ground to keep the machine raised.

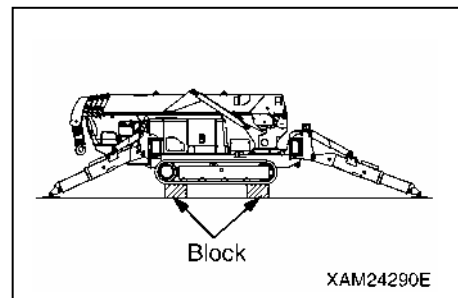

3. Remove the filler plug (F) from the slewing reduction gear case.
4. Crawl under the machine and place a drain pan directly underneath the drain plug (P) of the slewing reduction gear case to receive drained oil.
5. Remove the drain plug (P) slowly to drain the oil, keeping from contact with draining oil.
6. Check the drained oil. If check finds a considerable amount of metal powder and foreign objects, contact our sales service agency.
7. Put in the drain plug (P) and secure it.
8. Supply the gear oil to the slewing reduction gear case through the filler plug (F).

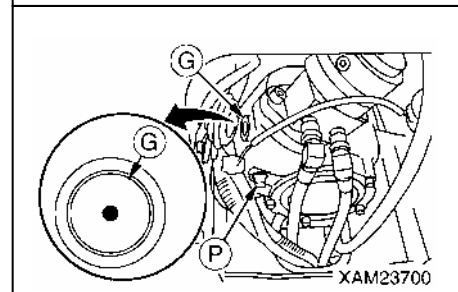
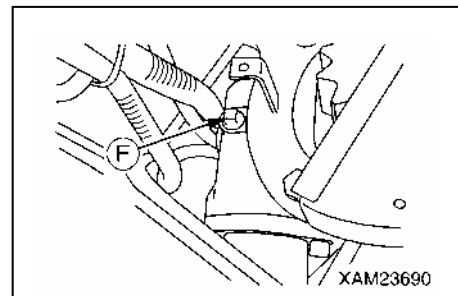

### NOTES

- The gear oil must be filled from the filler cap , up to the midpoint of the site gauge (G).
- Wipe off the oil completely if spilled.

9. Put in the filler plug (F) and secure it after oil replacement.
10. See “Operation 2.24 Outrigger Stowing Operation” to stow the outriggers.

## [5] OIL REPLACEMENT IN WINCH REDUCTION GEAR CASE

### **⚠ WARNING**

Oil will be at elevated temperatures immediately after engine operation, which urges you not to unplug the inspection port and drain port. Unplug the port with the oil cold.

### **CAUTION**

- See “Maintenance 5.1 Use of Lubricating Oil According to Temperature” for which oil to be used.
- Use seal tape, etc. at the thread of the plug to stop the oil leak and securely tighten the plug after refilling with the oil.

- Oil drain pan: A 1-liter container
- Hexagonal wrench for plug removal: 8mm
- Quantity of oil for replacement: 0.75L

1. Place the machine on a level surface.
2. See “Operation 2.14 Outrigger Setting Operation” to rotate the rotary of the “outrigger (1)” outward.
3. Slowly rotate the winch until the plug (P) is visible, and once the plug (P) is visible, set the plug (P) to the lowest position.
4. Place a drain pan directly under the plug (P) to receive drained oil.
5. Use the hexagonal wrench to remove the plug (P). The gear oil is drained from the winch reduction gear case upon plug removal.
6. Once the gear oil is fully drained out of the winch reduction gear case, rotate the winch slowly until the plug (P) hole is visible through the hole above the pin.
7. Replenish the standard amount (0.75 liters) of gear oil using an oil pump or similar tool through the plug (P) hole.

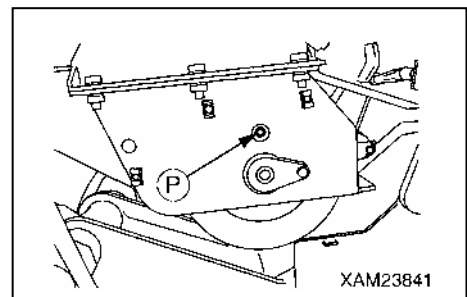
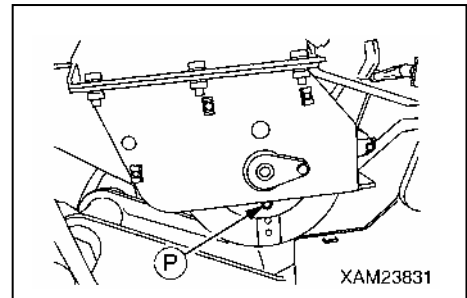

### **NOTES**

Wipe off the oil completely if spilled.

8. Put in the plug (P) and secure it upon completion of oil replenishment.
9. See “Operation 2.24 Outrigger Stowing Operation” to stow the “outrigger (1)”.

## [6] OIL REPLACEMENT IN TRAVELING MOTOR REDUCTION GEAR CASE

### CAUTION

- See “Maintenance 5.1 Use of Lubricating Oil According to Temperature” for which oil to be used.
- Use seal tape, etc. at the thread of the filler plug to stop the oil leak and securely tighten the plug after refilling with the oil.

- Oil drain pan: A 1-liter container
- Quantity of oil for replacement: 1.0L

1. Place the machine on a level surface.
2. Move the machine forward and backward to position it immediately above the drain plug (P) of the traveling motor reduction gear case.

### NOTES

This machine is equipped with two drain plugs (P). Either drain plug must be positioned directly underneath the machine.

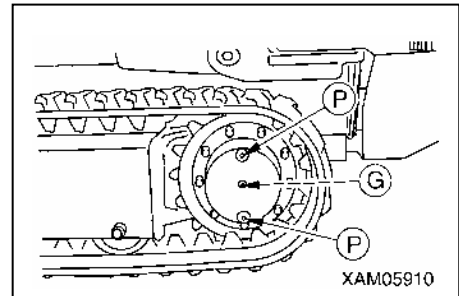

3. Place a drain pan directly under the lower drain plug (P) to receive drained oil.
4. Remove the upper drain plug (P) and oil inspection plug (G).
5. Remove the lower drain plug (P) slowly to drain the oil, keeping from contact with draining oil.
6. Check the drained oil. If check finds a considerable amount of metal powder and foreign objects, contact our sales service agency.
7. Put in the lower drain plug (P) and secure it.
8. Supply the gear oil to the traveling motor reduction gear case through the upper drain plug hole (P).

### NOTES

Pour in the gear oil until the oil comes out of the oil level check plug (G).

9. Put in the upper drain plug (P) and oil inspection plug (G), and secure them after oil replenishment.

### NOTES

Wipe off the oil completely if spilled.

## [7] INSPECTION/ADJUSTMENT ENGINE VALVE CLEARANCE

Inspection and adjustment of valve clearance require special tools. Contact us or our sales service agency to request inspection and repair.

## **8.11 MAINTENANCE EVERY 1500 HOURS**

Perform this maintenance in tandem with maintenance every 30/50/250/500/1000 hours.

### **[1] INSPECTION/CLEANING/TESTING FUEL INJECTOR**

Inspection, cleaning, and test of the fuel injector require special tools.

Contact us or our sales service agency to request inspection and repair.

### **[2] CHECKING CRANKCASE BREATHER**

Crankcase breather inspection requires special tools.

Contact us or our sales service agency to request inspection and repair.

## **8.12 MAINTENANCE EVERY 2000 HOURS**

Perform this maintenance in tandem with maintenance every 30/50/250/500/1000 hours.

### **[1] CHECKING/REPAIR ENGINE VALVE SEAT**

Inspection and repair of the valve seat require special tools.

Contact us or our sales service agency to request inspection and repair.

### **[2] CHECKING ALTERNATOR AND STARTER**

#### **CAUTION**

**Inspection every 1000 hours is recommended in case of frequent engine starting.**

There may be a wearing down of the brush and insufficient grease.

Contact us or our sales service agency to request inspection and repair.





# SPECIFICATIONS

|   |     |
|---|-----|
| 1. SPECIFICATION LIST                     | 5-2 |
| 2. SPECIFICATION DIMENSIONAL DRAWING      | 5-4 |
| 3. DIMENSIONAL DRAWING OF OUTRIGGER WIDTH | 5-5 |
| 4. RATED TOTAL LOAD TABLE                 | 5-6 |
| 5. WORKING RADIUS AND LIFTING HEIGHT      | 5-9 |

# 1. SPECIFICATION LIST

| System / Item           |   | MC-305C-2  |
|-------------------------|---|--|
| Mass and dimensions     | Machine mass                              | 3900kg   |
|                         | Overall length × width × height           | 4285mm x 1280mm x 1695mm   |
|                         | Distance between idler and sprocket       | 1750mm   |
|                         | Track gauge                               | 980mm  |
|                         | Track width                               | 300mm  |
| Capacity                | Maximum rated total load × working radius | 2.98t x 2.5m   |
|                         | Maximum working radius                    | 12.16m   |
|                         | Maximum lifting height                    | 12.52m   |
| Winch system            | Method                                    | Swash plate axial piston motor, planetary gear deceleration, friction plate brake  |
|                         | Winding speed                             | 13.5m/min (4th drum, 4 ropes)  |
|                         | Hoisting rope                             | IWRC 6 x WS (26) 0/0 Type B φ8 x 73m   |
| Boom telescoping system | Method                                    | Sequentially telescoping hydraulic cylinder (3 pieces) + Sheave-embedded wire rope expansion device (1 piece), (With a hydraulic automatic locking device)                                 |
|                         | Boom type                                 | Pentagonal section, hydraulic automatic extension, 5-stage boom (Stage 2/3: Sequentially telescoping, Stage 4/5: Simultaneous telescoping)   |
|                         | Boom length                               | 3.695m – 5.945m – 8.145m – 10.315m – 12.485m   |
|                         | Boom telescoping stroke/ time             | 8.79m/26sec  |
| Derrick system          | Method                                    | Direct push-type hydraulic double-acting cylinder (2 pieces), (With a hydraulic automatic locking device)  |
|                         | Derrick angle/ time                       | 0 to 80 deg./14.5sec   |
| Slewing system          | Method                                    | Swing bearing, hydraulic motor drive, Reduction gear: Worm + Reduction spur gear, Brake: Worm-selflock   |
|                         | Slewing angle/ speed                      | 360 deg. (continuous)/ 25sec (2.4min <sup>-1</sup> )   |
| Outrigger system        | Method                                    | Extension/ground: Direct push-type hydraulic cylinder (With a hydraulic automatic locking device)  |
|                         | Overall width of extended outriggers      | (Front) 4504mm x (Right/left) 4888mm x (Rear) 4396mm   |
| Traveling system        | Method                                    | Hydraulic two-speed motor drive, Variable speed, Built-in brake  |
|                         | Travel speed                              | Forward/backward: 0 – 2.8km/h  |
|                         | Gradeability                              | 23 deg.  |
|                         | Ground pressure                           | 36.3kPa (0.37kgf/cm <sup>2</sup> )   |
| Hydraulic system        | Hydraulic pump                            | Double-throw variable piston pump (13cc/rev × 2)   |
|                         | Rated pressure                            | Traveling: 20.6MPa (210kgf/cm <sup>2</sup> )<br>Crane high-pressure relief: 20.1MPa (205kgf/cm <sup>2</sup> )<br>Crane low-pressure relief: 4.41 to 6.37MPa (45 to 65kgf/cm <sup>2</sup> ) |
|                         | Hydraulic oil tank capacity               | 56L  |

| System / Item |   | MC-305C-2   |
|---------------|---|---|
| Engine        | Model   | Yanmar 3TNV76   |
|               | Type  | Vertical in-line 3-cylinder, Water cooled, 4-cycle (special vortex) |
|               | Displacement  | 1.115L (1115cc)   |
|               | Rated output (continuous)   | 15.2kW/2500min <sup>-1</sup> (20.7PS/2500rpm)                       |
|               | Fuel tank capacity  | Light oil/ 40L  |
| Battery       | Model   | 60B24R (DC12V x 1 piece)  |
| Safety device | Over hoist detector / automatic stop device, three-winding stop alarm / automatic stop device, load indicator, hydraulic safety valve, hydraulic automatic locking device, slinging rope detachment protector, alarm buzzer, audio alarm, level, crane tip-over alarm (an alarm issued in the event of the crane operation at 3-degree inclination and traveling at 15-degree inclination), traveling lever lock, traveling/crane/outrigger selector switch (designed to prevent the machine from craning at traveling), outrigger safety device (outrigger interlock and crane interlock), moment limiter (working envelope limited), working status lamp, outrigger non-installation warning lamp |   |

## 2. SPECIFICATION DIMENSIONAL DRAWING

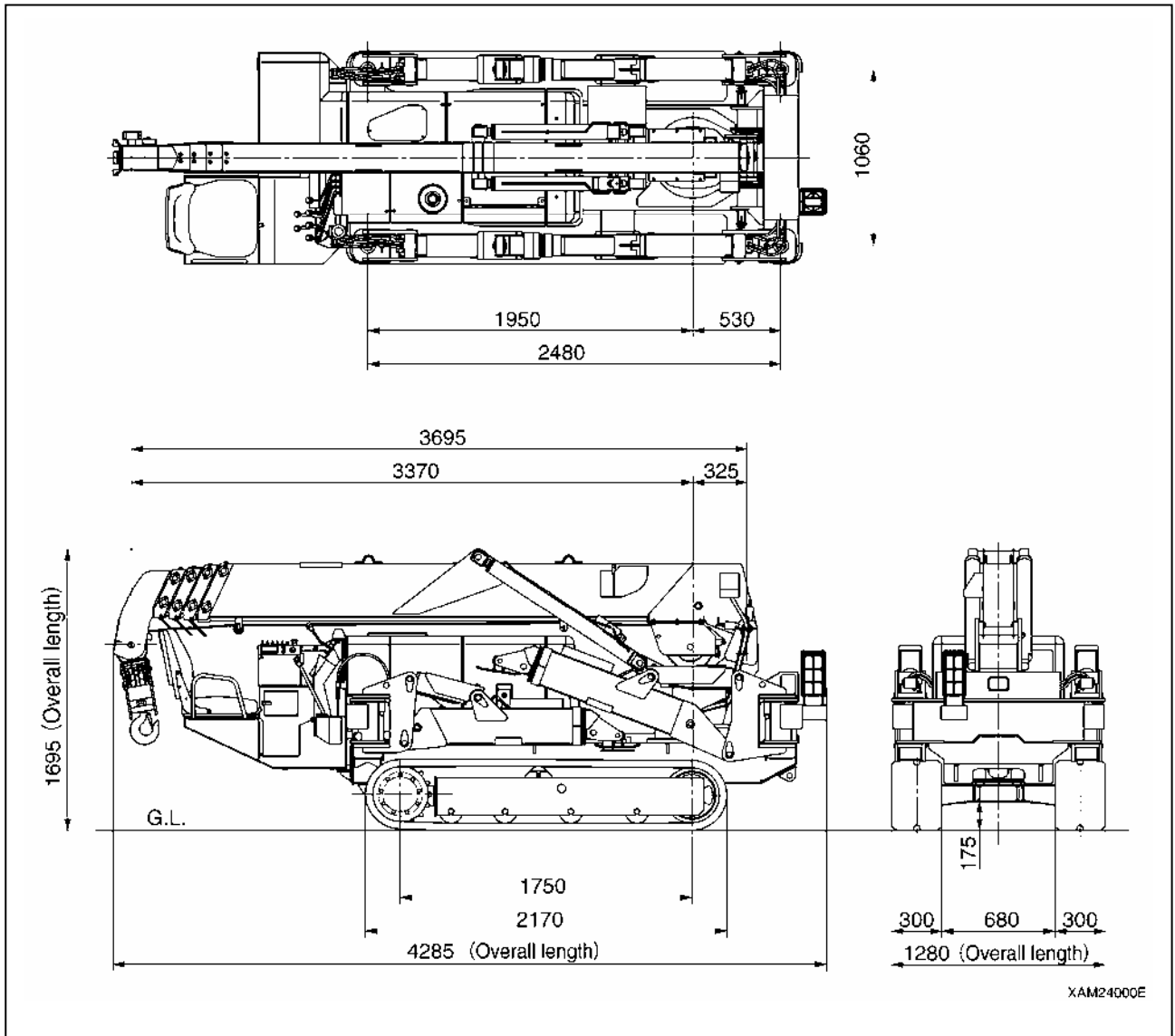

### 3. DIMENSIONAL DRAWING OF OUTRIGGER WIDTH

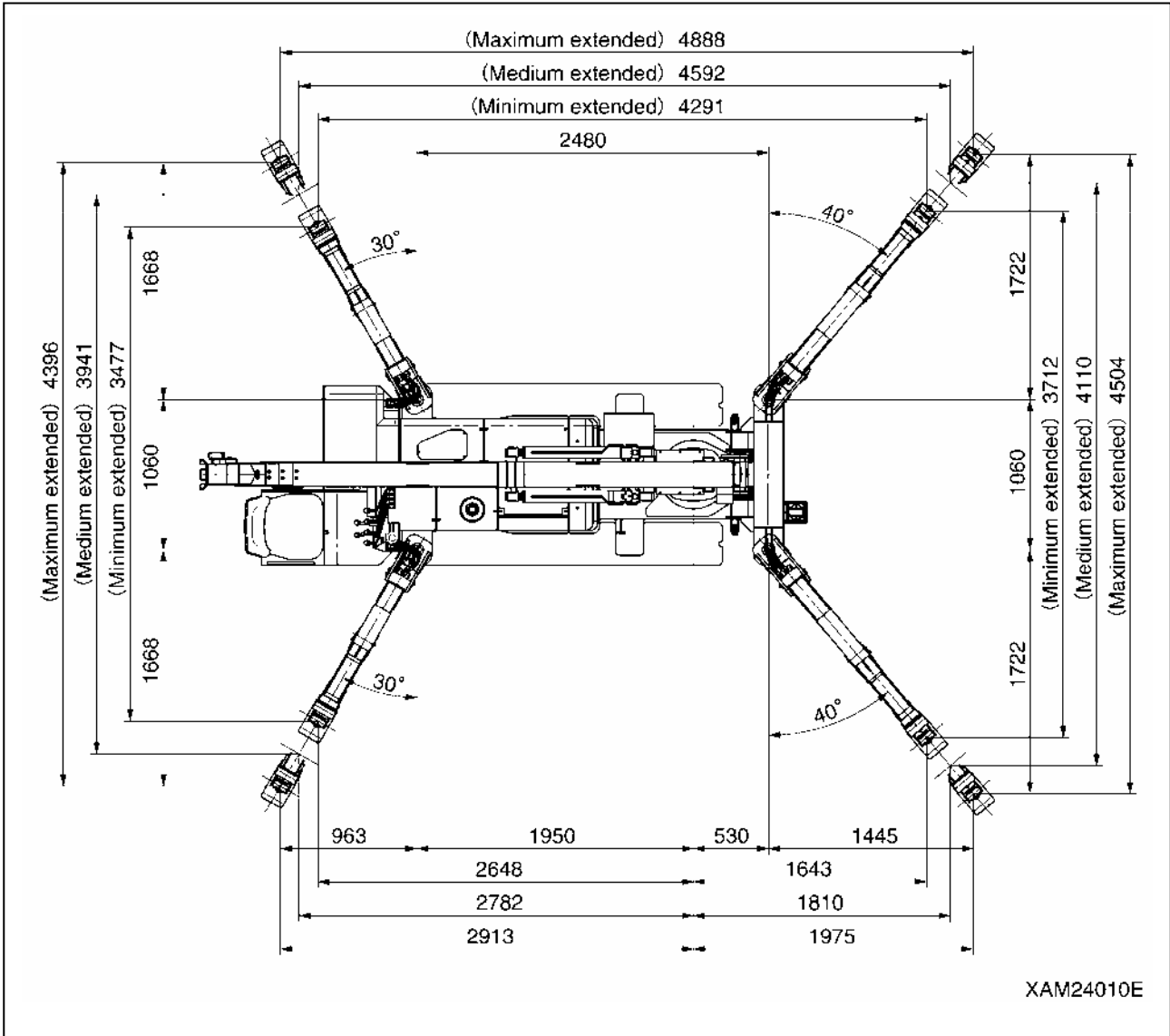

## 4. RATED TOTAL LOAD CHART

### [1] RATED TOTAL LOAD CHART AT WIRE ROPE 4 FALLS

\* The rated total load is a load including the mass of a hoisting accessory (hook: 30kg).

| OUTRIGGER EXTENDED TO MAXIMUM |                       |                    |                       |                      |                       |                          |                       |
|-------------------------------|-----------------------|--------------------|-----------------------|----------------------|-----------------------|--------------------------|-----------------------|
| BOOM (1)+(2)                  |                       | BOOM (1)+(2)+(3)   |                       | BOOM (1)+(2)+(3)+(4) |                       | BOOM (1)+(2)+(3)+(4)+(5) |                       |
| Working radius (m)            | Rated total load (kg) | Working radius (m) | Rated total load (kg) | Working radius (m)   | Rated total load (kg) | Working radius (m)       | Rated total load (kg) |
| 2.50                          | 2980                  | 2.70               | 2270                  | 4.00                 | 1080                  | 4.50                     | 790                   |
| 3.00                          | 2390                  | 3.00               | 2120                  | 4.50                 | 985                   | 5.00                     | 660                   |
| 3.50                          | 1990                  | 3.50               | 1680                  | 5.00                 | 880                   | 6.00                     | 520                   |
| 4.00                          | 1710                  | 4.00               | 1440                  | 6.00                 | 770                   | 7.00                     | 430                   |
| 4.50                          | 1490                  | 4.50               | 1260                  | 7.00                 | 670                   | 8.00                     | 380                   |
| 5.00                          | 1340                  | 5.00               | 1110                  | 8.00                 | 570                   | 9.00                     | 340                   |
| 5.62                          | 1160                  | 5.50               | 990                   | 9.00                 | 500                   | 10.00                    | 310                   |
| --                            | --                    | 6.00               | 880                   | 9.99                 | 435                   | 11.00                    | 280                   |
| --                            | --                    | 7.00               | 730                   | --                   | --                    | 12.16                    | 260                   |
| --                            | --                    | 7.82               | 630                   | --                   | --                    | --                       | --                    |

| OUTRIGGER EXTENDED TO MEDIUM |                       |                    |                       |                      |                       |                          |                       |
|------------------------------|-----------------------|--------------------|-----------------------|----------------------|-----------------------|--------------------------|-----------------------|
| BOOM (1)+(2)                 |                       | BOOM (1)+(2)+(3)   |                       | BOOM (1)+(2)+(3)+(4) |                       | BOOM (1)+(2)+(3)+(4)+(5) |                       |
| Working radius (m)           | Rated total load (kg) | Working radius (m) | Rated total load (kg) | Working radius (m)   | Rated total load (kg) | Working radius (m)       | Rated total load (kg) |
| 2.50                         | 2980                  | 2.70               | 2270                  | 4.00                 | 1060                  | 4.50                     | 780                   |
| 3.00                         | 2360                  | 3.00               | 2090                  | 4.50                 | 950                   | 5.00                     | 650                   |
| 3.50                         | 1960                  | 3.50               | 1680                  | 5.00                 | 860                   | 6.00                     | 500                   |
| 4.00                         | 1680                  | 4.00               | 1420                  | 6.00                 | 750                   | 7.00                     | 410                   |
| 4.50                         | 1380                  | 4.50               | 1240                  | 7.00                 | 630                   | 8.00                     | 360                   |
| 5.00                         | 1140                  | 5.00               | 1070                  | 8.00                 | 490                   | 9.00                     | 320                   |
| 5.62                         | 950                   | 5.50               | 950                   | 9.00                 | 410                   | 10.00                    | 290                   |
| --                           | --                    | 6.00               | 800                   | 9.99                 | 350                   | 11.00                    | 260                   |
| --                           | --                    | 7.00               | 610                   | --                   | --                    | 12.16                    | 250                   |
| --                           | --                    | 7.82               | 520                   | --                   | --                    | --                       | --                    |

| OUTRIGGER EXTENDED TO MINIMUM |                       |                    |                       |                      |                       |                          |                       |
|-------------------------------|-----------------------|--------------------|-----------------------|----------------------|-----------------------|--------------------------|-----------------------|
| BOOM (1)+(2)                  |                       | BOOM (1)+(2)+(3)   |                       | BOOM (1)+(2)+(3)+(4) |                       | BOOM (1)+(2)+(3)+(4)+(5) |                       |
| Working radius (m)            | Rated total load (kg) | Working radius (m) | Rated total load (kg) | Working radius (m)   | Rated total load (kg) | Working radius (m)       | Rated total load (kg) |
| 2.50                          | 2980                  | 2.70               | 2270                  | 4.00                 | 1060                  | 4.50                     | 780                   |
| 3.00                          | 2350                  | 3.00               | 2090                  | 4.50                 | 950                   | 5.00                     | 650                   |
| 3.50                          | 1800                  | 3.50               | 1680                  | 5.00                 | 860                   | 6.00                     | 500                   |
| 4.00                          | 1430                  | 4.00               | 1370                  | 6.00                 | 680                   | 7.00                     | 410                   |
| 4.50                          | 1140                  | 4.50               | 1120                  | 7.00                 | 530                   | 8.00                     | 360                   |
| 5.00                          | 950                   | 5.00               | 910                   | 8.00                 | 420                   | 9.00                     | 320                   |
| 5.62                          | 790                   | 5.50               | 790                   | 9.00                 | 340                   | 10.00                    | 290                   |
| --                            | --                    | 6.00               | 670                   | 9.99                 | 300                   | 11.00                    | 240                   |
| --                            | --                    | 7.00               | 510                   | --                   | --                    | 12.16                    | 210                   |
| --                            | --                    | 7.82               | 430                   | --                   | --                    | --                       | --                    |

**[2] RATED TOTAL LOAD CHART AT WIRE ROPE 2 FALLS**

\* The rated total load is a load including the mass of a hoisting accessory (hook: 30kg).

| OUTRIGGER EXTENDED TO MAXIMUM |                       |                    |                       |                      |                       |                          |                       |
|-------------------------------|-----------------------|--------------------|-----------------------|----------------------|-----------------------|--------------------------|-----------------------|
| BOOM (1)+(2)                  |                       | BOOM (1)+(2)+(3)   |                       | BOOM (1)+(2)+(3)+(4) |                       | BOOM (1)+(2)+(3)+(4)+(5) |                       |
| Working radius (m)            | Rated total load (kg) | Working radius (m) | Rated total load (kg) | Working radius (m)   | Rated total load (kg) | Working radius (m)       | Rated total load (kg) |
| 2.50                          | 1480                  | 2.70               | 1480                  | 4.00                 | 1080                  | 4.50                     | 790                   |
| 3.00                          | 1480                  | 3.00               | 1480                  | 4.50                 | 985                   | 5.00                     | 660                   |
| 3.50                          | 1480                  | 3.50               | 1480                  | 5.00                 | 880                   | 6.00                     | 520                   |
| 4.00                          | 1480                  | 4.00               | 1440                  | 6.00                 | 770                   | 7.00                     | 430                   |
| 4.50                          | 1480                  | 4.50               | 1260                  | 7.00                 | 670                   | 8.00                     | 380                   |
| 5.00                          | 1340                  | 5.00               | 1110                  | 8.00                 | 570                   | 9.00                     | 340                   |
| 5.62                          | 1160                  | 5.50               | 990                   | 9.00                 | 500                   | 10.00                    | 310                   |
| --                            | --                    | 6.00               | 880                   | 9.99                 | 435                   | 11.00                    | 280                   |
| --                            | --                    | 7.00               | 730                   | --                   | --                    | 12.16                    | 260                   |
| --                            | --                    | 7.82               | 630                   | --                   | --                    | --                       | --                    |

| OUTRIGGER EXTENDED TO MEDIUM |                       |                    |                       |                      |                       |                          |                       |
|------------------------------|-----------------------|--------------------|-----------------------|----------------------|-----------------------|--------------------------|-----------------------|
| BOOM (1)+(2)                 |                       | BOOM (1)+(2)+(3)   |                       | BOOM (1)+(2)+(3)+(4) |                       | BOOM (1)+(2)+(3)+(4)+(5) |                       |
| Working radius (m)           | Rated total load (kg) | Working radius (m) | Rated total load (kg) | Working radius (m)   | Rated total load (kg) | Working radius (m)       | Rated total load (kg) |
| 2.50                         | 1480                  | 2.70               | 1480                  | 4.00                 | 1060                  | 4.50                     | 780                   |
| 3.00                         | 1480                  | 3.00               | 1480                  | 4.50                 | 950                   | 5.00                     | 650                   |
| 3.50                         | 1480                  | 3.50               | 1480                  | 5.00                 | 860                   | 6.00                     | 500                   |
| 4.00                         | 1480                  | 4.00               | 1420                  | 6.00                 | 750                   | 7.00                     | 410                   |
| 4.50                         | 1380                  | 4.50               | 1240                  | 7.00                 | 630                   | 8.00                     | 360                   |
| 5.00                         | 1140                  | 5.00               | 1070                  | 8.00                 | 490                   | 9.00                     | 320                   |
| 5.62                         | 950                   | 5.50               | 950                   | 9.00                 | 410                   | 10.00                    | 290                   |
| --                           | --                    | 6.00               | 800                   | 9.99                 | 350                   | 11.00                    | 260                   |
| --                           | --                    | 7.00               | 610                   | --                   | --                    | 12.16                    | 250                   |
| --                           | --                    | 7.82               | 520                   | --                   | --                    | --                       | --                    |

| OUTRIGGER EXTENDED TO MINIMUM |                       |                    |                       |                      |                       |                          |                       |
|-------------------------------|-----------------------|--------------------|-----------------------|----------------------|-----------------------|--------------------------|-----------------------|
| BOOM (1)+(2)                  |                       | BOOM (1)+(2)+(3)   |                       | BOOM (1)+(2)+(3)+(4) |                       | BOOM (1)+(2)+(3)+(4)+(5) |                       |
| Working radius (m)            | Rated total load (kg) | Working radius (m) | Rated total load (kg) | Working radius (m)   | Rated total load (kg) | Working radius (m)       | Rated total load (kg) |
| 2.50                          | 1480                  | 2.70               | 1480                  | 4.00                 | 1060                  | 4.50                     | 780                   |
| 3.00                          | 1480                  | 3.00               | 1480                  | 4.50                 | 950                   | 5.00                     | 650                   |
| 3.50                          | 1480                  | 3.50               | 1480                  | 5.00                 | 860                   | 6.00                     | 500                   |
| 4.00                          | 1430                  | 4.00               | 1370                  | 6.00                 | 680                   | 7.00                     | 410                   |
| 4.50                          | 1140                  | 4.50               | 1120                  | 7.00                 | 530                   | 8.00                     | 360                   |
| 5.00                          | 950                   | 5.00               | 910                   | 8.00                 | 420                   | 9.00                     | 320                   |
| 5.62                          | 790                   | 5.50               | 790                   | 9.00                 | 340                   | 10.00                    | 290                   |
| --                            | --                    | 6.00               | 670                   | 9.99                 | 300                   | 11.00                    | 240                   |
| --                            | --                    | 7.00               | 510                   | --                   | --                    | 12.16                    | 210                   |
| --                            | --                    | 7.82               | 430                   | --                   | --                    | --                       | --                    |



**[3] RATED TOTAL LOAD CHART AT WIRE ROPE 1 FALL**

\* The rated total load is a load including the mass of a hoisting accessory (hook: 30kg).

| OUTRIGGER EXTENDED TO MAXIMUM |                       |                    |                       |                      |                       |                          |                       |
|-------------------------------|-----------------------|--------------------|-----------------------|----------------------|-----------------------|--------------------------|-----------------------|
| BOOM (1)+(2)                  |                       | BOOM (1)+(2)+(3)   |                       | BOOM (1)+(2)+(3)+(4) |                       | BOOM (1)+(2)+(3)+(4)+(5) |                       |
| Working radius (m)            | Rated total load (kg) | Working radius (m) | Rated total load (kg) | Working radius (m)   | Rated total load (kg) | Working radius (m)       | Rated total load (kg) |
| 2.50                          | 750                   | 2.70               | 750                   | 4.00                 | 750                   | 4.50                     | 750                   |
| 3.00                          | 750                   | 3.00               | 750                   | 4.50                 | 750                   | 5.00                     | 660                   |
| 3.50                          | 750                   | 3.50               | 750                   | 5.00                 | 750                   | 6.00                     | 520                   |
| 4.00                          | 750                   | 4.00               | 750                   | 6.00                 | 750                   | 7.00                     | 430                   |
| 4.50                          | 750                   | 4.50               | 750                   | 7.00                 | 670                   | 8.00                     | 380                   |
| 5.00                          | 750                   | 5.00               | 750                   | 8.00                 | 570                   | 9.00                     | 340                   |
| 5.62                          | 750                   | 5.50               | 750                   | 9.00                 | 500                   | 10.00                    | 310                   |
| --                            | --                    | 6.00               | 750                   | 9.99                 | 435                   | 11.00                    | 280                   |
| --                            | --                    | 7.00               | 730                   | --                   | --                    | 12.16                    | 260                   |
| --                            | --                    | 7.82               | 630                   | --                   | --                    | --                       | --                    |

| OUTRIGGER EXTENDED TO MEDIUM |                       |                    |                       |                      |                       |                          |                       |
|------------------------------|-----------------------|--------------------|-----------------------|----------------------|-----------------------|--------------------------|-----------------------|
| BOOM (1)+(2)                 |                       | BOOM (1)+(2)+(3)   |                       | BOOM (1)+(2)+(3)+(4) |                       | BOOM (1)+(2)+(3)+(4)+(5) |                       |
| Working radius (m)           | Rated total load (kg) | Working radius (m) | Rated total load (kg) | Working radius (m)   | Rated total load (kg) | Working radius (m)       | Rated total load (kg) |
| 2.50                         | 750                   | 2.70               | 750                   | 4.00                 | 750                   | 4.50                     | 750                   |
| 3.00                         | 750                   | 3.00               | 750                   | 4.50                 | 750                   | 5.00                     | 650                   |
| 3.50                         | 750                   | 3.50               | 750                   | 5.00                 | 750                   | 6.00                     | 500                   |
| 4.00                         | 750                   | 4.00               | 750                   | 6.00                 | 750                   | 7.00                     | 410                   |
| 4.50                         | 750                   | 4.50               | 750                   | 7.00                 | 630                   | 8.00                     | 360                   |
| 5.00                         | 750                   | 5.00               | 750                   | 8.00                 | 490                   | 9.00                     | 320                   |
| 5.62                         | 750                   | 5.50               | 750                   | 9.00                 | 410                   | 10.00                    | 290                   |
| --                           | --                    | 6.00               | 750                   | 9.99                 | 350                   | 11.00                    | 260                   |
| --                           | --                    | 7.00               | 610                   | --                   | --                    | 12.16                    | 250                   |
| --                           | --                    | 7.82               | 520                   | --                   | --                    | --                       | --                    |

| OUTRIGGER EXTENDED TO MINIMUM |                       |                    |                       |                      |                       |                          |                       |
|-------------------------------|-----------------------|--------------------|-----------------------|----------------------|-----------------------|--------------------------|-----------------------|
| BOOM (1)+(2)                  |                       | BOOM (1)+(2)+(3)   |                       | BOOM (1)+(2)+(3)+(4) |                       | BOOM (1)+(2)+(3)+(4)+(5) |                       |
| Working radius (m)            | Rated total load (kg) | Working radius (m) | Rated total load (kg) | Working radius (m)   | Rated total load (kg) | Working radius (m)       | Rated total load (kg) |
| 2.50                          | 750                   | 2.70               | 750                   | 4.00                 | 750                   | 4.50                     | 750                   |
| 3.00                          | 750                   | 3.00               | 750                   | 4.50                 | 750                   | 5.00                     | 650                   |
| 3.50                          | 750                   | 3.50               | 750                   | 5.00                 | 750                   | 6.00                     | 500                   |
| 4.00                          | 750                   | 4.00               | 750                   | 6.00                 | 680                   | 7.00                     | 410                   |
| 4.50                          | 750                   | 4.50               | 750                   | 7.00                 | 530                   | 8.00                     | 360                   |
| 5.00                          | 750                   | 5.00               | 750                   | 8.00                 | 420                   | 9.00                     | 320                   |
| 5.62                          | 750                   | 5.50               | 750                   | 9.00                 | 340                   | 10.00                    | 290                   |
| --                            | --                    | 6.00               | 670                   | 9.99                 | 300                   | 11.00                    | 240                   |
| --                            | --                    | 7.00               | 510                   | --                   | --                    | 12.16                    | 210                   |
| --                            | --                    | 7.82               | 430                   | --                   | --                    | --                       | --                    |

# 5. WORKING RADIUS AND LIFTING HEIGHT

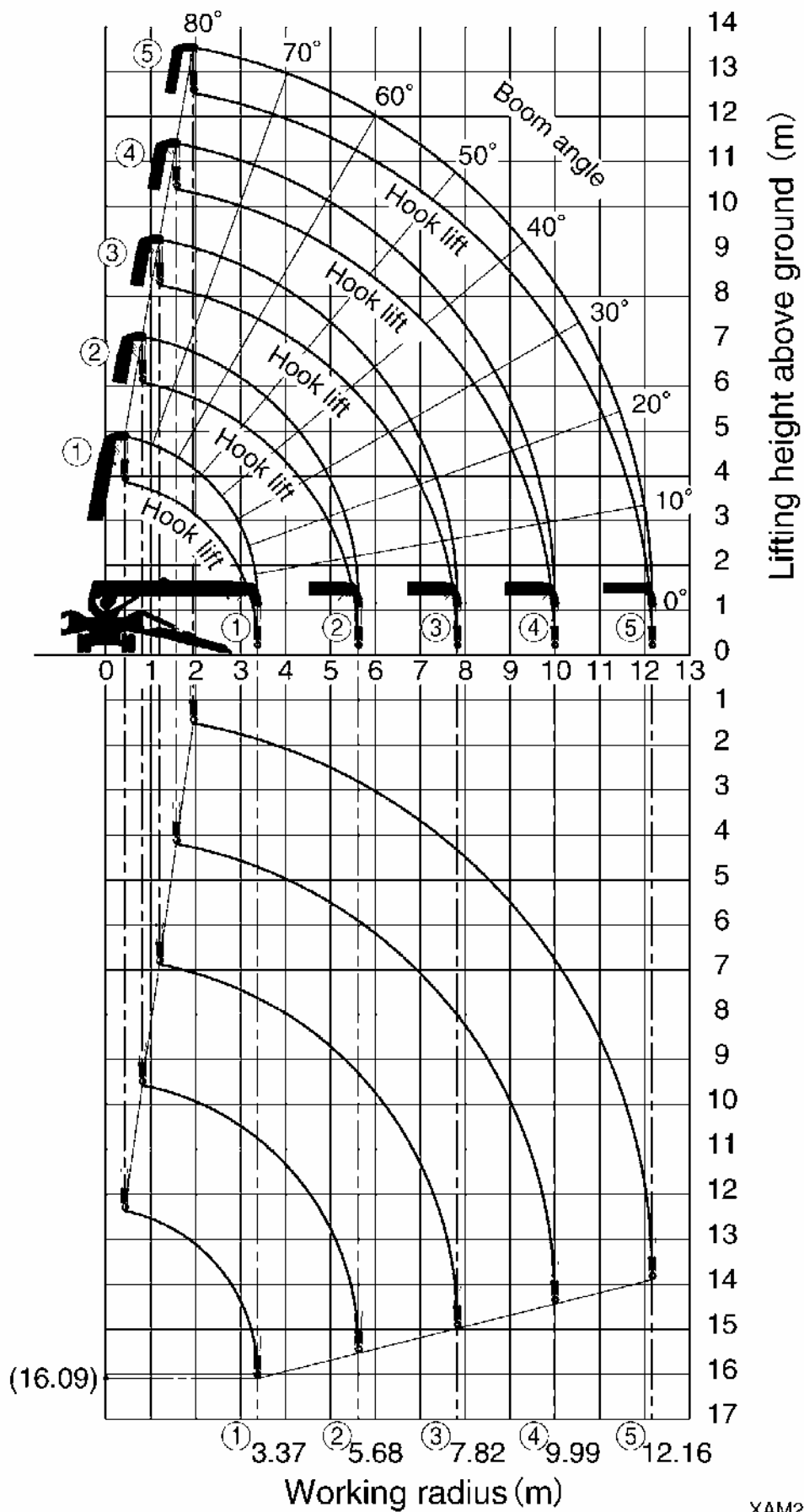

XAM24280E



# INTERACTIVE REMOTE CONTROL

|  |      |
|--|------|
| 1. OUTLINE OF REMOTE CONTROLLER              | 6- 2 |
| 2. SAFETY PRECAUTIONS                        | 6- 4 |
| 3. LOCATIONS OF SAFETY LABELS                | 6- 8 |
| 4. COMPONENTS OF THE TRANSMITTER             | 6-10 |
| 5. COMPONENTS OF THE RECEIVER                | 6-16 |
| 6. SETTING UP OPERATION MODES OF TRANSMITTER | 6-20 |
| 7. CHECKING BEFORE OPERATION                 | 6-28 |
| 8. OPERATION                                 | 6-39 |
| 9. TROUBLE SHOOTING                          | 6-51 |
| 10.SYSTEM SPECIFICATIONS                     | 6-54 |

# 1. OUTLINE OF REMOTE CONTROLLER

## 1.1 FEATURE

This system is designed principally for the following purposes:

This Interactive Remote Controller includes both Transmitter and Receiver which facilitate remote control of the Crane which is purchased with this device.

This Interactive Remote Controller provides an operation of the Crane at the most convenient place away from it within a range of the length of the connection cable. In addition, its LCD screen indicates “Rated total load”, “Actual Load” and “Load factor (by a bar chart)”, which ensures proper operation based on these information.

## 1.2 CONFIGURATION

The configuration of this system is as a below:

### [1] TRANSMITTER

The Transmitter is equipped with LCD screen (1), Six control buttons (2), Four operation levers (3), Accelerator lever (4), Grip (5) and Connection cable (6).

The Transmitter sends signals for crane operations to the Receiver through the connection cable so that remote operation of the Crane can be carried out. In addition, the Transmitter collects the load data from the Moment limiter of the Crane through the cable, which are displayed in the LCD screen as “Rated total load”, “Actual load” and “Load factor (by a bar chart)”.

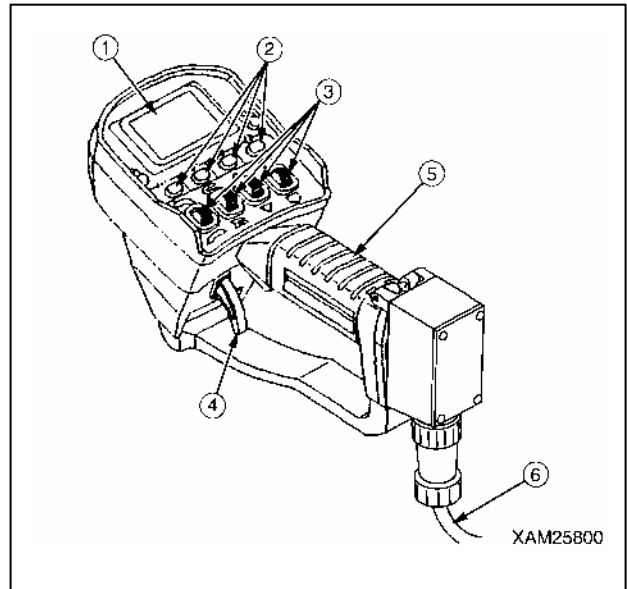

### [2] RECEIVER

The Receiver which is installed in the Crane equips with Control box (1), Main switch (2), Monitor display (3), and Receptacle (4), etc.

The Receiver receives operation signals from the Transmitter through the connection cable which control the Crane.

Further, the load data from the Moment limiter of the Crane are delivered to the Transmitter through the cable.

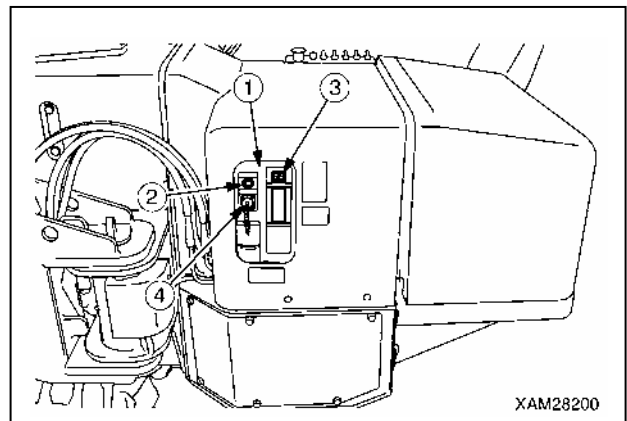

## 1.3 FUNCTIONS OF REMOTE CONTROL SYSTEM

- The Transmitter allows one hand operation, which enables craning works, such as holding the load by the other hand or slinging, by one person.
- The Accelerator lever facilitates the control of the Crane operation speed from stand-by condition to the maximum speed.
- The LCD screen of the Transmitter indicates operation status, such as “Rated total load”, “Actual load”, “Load factor (by a bar chart)”, “Speed control”, “Outrigger setting” and so on, to provide easy confirmation.



In addition, the LCD screen of the Transmitter shows error messages in the event where the Transmitter has a failure, so that the detection and correction of the failure is promptly accomplished.

Still more, the voice messages will notify the Transmitter conditions or warning alerts.

- Depend on the operation requirement, manual operation on the console of the Crane is also available, in addition to handling by the remote control Transmitter.
- The connection by the cable between the Transmitter and Receiver allows secure communication between both.

## 2. SAFETY PRECAUTIONS

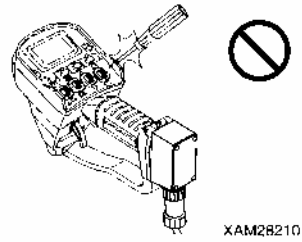
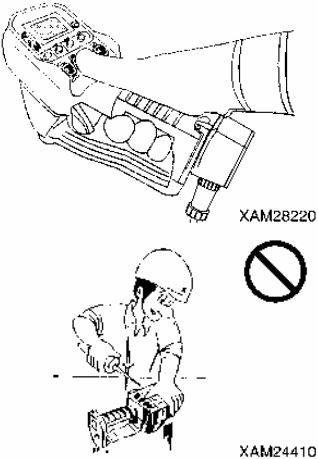
### 2. 1 For Safety Operations

| <b>NO MODIFICATION !</b>  |  |
|---|--|
| <ul style="list-style-type: none"><li>• Do not attempt to modify or disassemble the Transmitter and Receiver, or the accessories, which may cause an electrical shock or a fire.</li></ul>  |  <p>XAM28210</p>                        |
| <b>HOLDING THE TRANSMITTER</b>  |  |
| <ul style="list-style-type: none"><li>• The Transmitter is designed for one hand controls in general. Refer to the figure in the right for basic usage of the Transmitter. Levers and buttons can be manipulated by the thumb, while the Accelerator lever can be triggered by the forefinger. Other fingers should grab the grip to hold the Transmitter.</li><li>• Always manipulate levers and switches by fingers. Do not attempt to pick them by a sharp edge or such for manipulation. It may make an opening in the Transmitter which allows water to enter inside and brings its troubles or failures and cause a serious hazard.</li></ul> |  <p>XAM28220</p> <p>XAM24410</p>       |
| <b>NO WATER WASHING</b>   |  |
| <ul style="list-style-type: none"><li>• Always keep the Transmitter unsoiled, and clean it when necessary. Oil or mud on surface may cause mis-operation by slipping hands, which may result a serious hazard.</li><li>• Do not attempt water-wash the Transmitter, in any event. It allows water to enter inside and brings its troubles or failures and cause a serious hazard.</li><li>• Scrub the Transmitter and Receiver with a wet cloth from water or diluted detergent to remove the dirt. Avoid alkaline or alcoholic cleaners or sprayer cleaners which deteriorate plastics and produce cracks.</li></ul>                               |  <p>DO NOT<br/>PRESSURE<br/>WASH!</p> |

## NO SHOCK TO THE TRANSMITTER

- During the Transmitter operations, always use a hook belt (1) to prevent the unexpected drop of it.
- Always avoid an impact on the Transmitter, such as hitting it to any object.  
It may result in damage to the enclosure or internal components which may cause a failure or malfunction and bring electrical shock or other serious hazard.
- In the event of such damages, send us or to our agents for services.  
Use of such a damaged Transmitter will result in mis-operation and extend to electrical shock or other serious hazard.

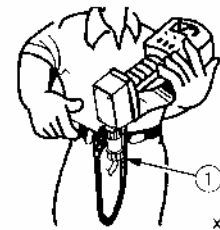

XAM28230



XAM24440

## PRECAUTION FOR OPERATIONS IN COLD SEASONS

- Avoid the use of the Transmitter in a condition where the ambient temperature makes sudden change or becomes extremely low ( $-10^{\circ}\text{C}$  or below) or cold air directly blows.  
Sudden change in temperature may cause dew formation inside the Transmitter and which causes failure or malfunction and leads to a serious hazard.
- In the winter times, allow sufficient idling prior to starting crane operations. In the winter, due to the low temperature, hydraulic fluid has higher viscosity. Such condition may result in a delay of functions in crane operations.
- Keep the Transmitter away from conditions as below for its storage, where the Transmitter enclosure may deform or discolor, or internal components may be damaged to bring malfunctions and a serious hazard:
  - Extremely low temperature ( $-20^{\circ}\text{C}$  or below) or direct cold air blow.
  - Direct sun ray.
  - Adjacent to warm air outlets of vehicles.
  - Adjacent to housing heating system.
  - High humidity.



XAM28240

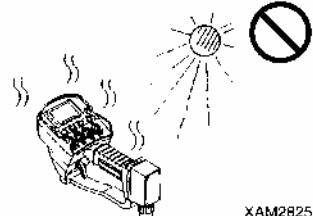

XAM28250

## PRECAUTIONS FOR HANDLING OF CONNECTION CABLE

Do not attempt to hang the Transmitter by the connection cable and fling it around, or bend the cable or thread on it. Such poor handling will damage the internal wires or produce other failures.

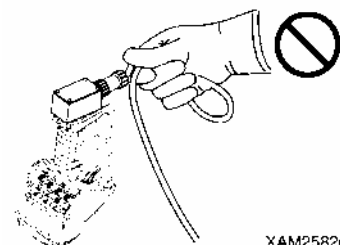

XAM25820



## 2.2 PRECAUTIONS FOR CRANE OPERATION

### WARNING

As to the matters to be attended in operation, refer to the section of "SAFETY", in addition to the following clauses.

### 2.2.1 PRIOR TO STARTING ENGINE

#### INSPECTION PRIOR TO STARTING ENGINE

At the beginning of the day's operation, perform the opening inspection as specified for this machine, prior to starting the engine.

Serious injury or death may arise when these inspections are neglected.

Any failure detected at the inspection must be properly corrected.

#### SAFETY MEASURES FOR STARTING ENGINE

- Ensure that nobody is around the Crane, or no obstacles, at starting the engine.
- Toot the horn for notice just before turning the ignition key.
- Never attempt to short the starter circuit for the purpose of the engine start, which may cause fire.

#### INSPECTION PRIOR TO TURN ON THE TRANSMITTER

- Check for any dirt, damage or cracks in the enclosure, control levers, operation buttons, or LCD screen.
- Ensure that the Transmitter's control levers, operation buttons and the Accelerator lever move smoothly and properly.
- Check the connection cable for damage or crack when the Remote Control Transmitter is in use.

#### INSPECTION FOLLOWING TURN ON THE TRANSMITTER

Ensure that LCD screen of the Transmitter provides correct indications.

- Switch to each operation mode, i.e. CRANE MODE and OUTRIGGER MODE, then check that LCD screen displays proper indications when each lever and button is manipulated. Further, verify the each applicable value of load in the Transmitter is identical to that of the Moment limiter display.

#### INSPECTION PRIOR TURN ON THE RECEIVER

- Check for any dirt, damage or cracks in the Receiver's Control box, Main switch, Monitor display and such.
- Ensure that the Receiver's Main switch moves smoothly and properly.

## 2.2.2 SUBSEQUENT TO STARTING ENGINE

### FUNCTION CHECK OF OUTRIGGER MODE BY THE TRANSMITTER, AND NOTICES FOR OPERATION

- Switch the operation mode to the “OUTRIGGER MODE” and confirm that the mode is switched correctly.
- Activate “Start/Reset button” to assure that the engine correctly starts.
- Activate “Stop/EMO button to assure the engine correctly stops.
- Operate the outrigger control switches to assure that the corresponding outrigger works correctly.
- Check that the position pins for outriggers and retainers are securely fixed.

### FUNCTION CHECK OF CRANE MODE BY THE TRANSMITTER AND NOTICES FOR OPERATION

- Before switching the operation mode to “CRANE MODE” always make all the outriggers extended and securely contacted on the ground.
- Switch the operation mode to the “CRANE MODE” and confirm that the mode is switched correctly.
- Activate levers for crane operations and assure that the Crane functions correctly.
- Always refer to the portable rated total load chart and avoid over-loaded operations.
- Activate the control levers and Accelerator lever of the Transmitter slowly in any time.

## 2.2.3 TERMINATING THE OPERATION

### PRECAUTIONS FOR TERMINATING THE OPERATION BY THE TRANSMITTER

- Before stowing the boom, switch the operation mode to “CRANE MODE” and confirm that the mode is switched correctly.
- Before stowing the outriggers, ensure that the boom and the hook is stowed in the correct positions.
- Before stowing the outriggers, switch the operation mode to “OUTRIGGER MODE” and confirm that the mode is switched correctly.
- When all the operation by the Transmitter is complete, always turn OFF the power of both the Transmitter and Receiver.
- On no condition, Transmitter will be ON unless the Crane is in operation, otherwise, unexpected touch or contact of operation levers or buttons of the Transmitter to any other object may cause un-desired motion of the Crane and a serious accident such as tipping or collision may occur.
- Where it is required to turn ON the Transmitter for the purpose of inspecting it or such, always keep the Receiver OFF and stop the engine, as well.

### 3. LOCATIONS OF SAFETY LABELS

Keep these labels always dirt free.

When labels come off, stick them again or replace to new ones.

In addition to safety labels shown below, several other labels are requisite. Treat them in the same manner.

Transmitter

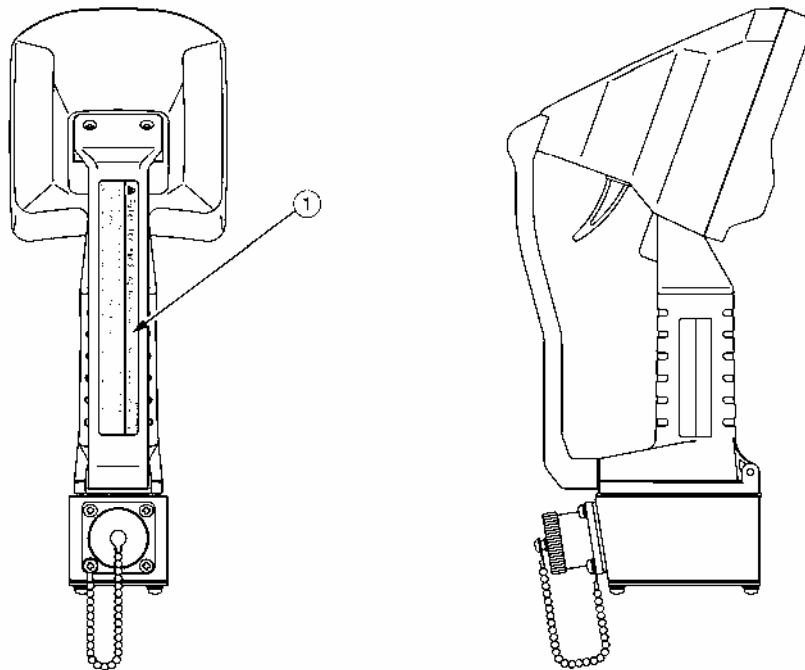

XAM28260

Receiver

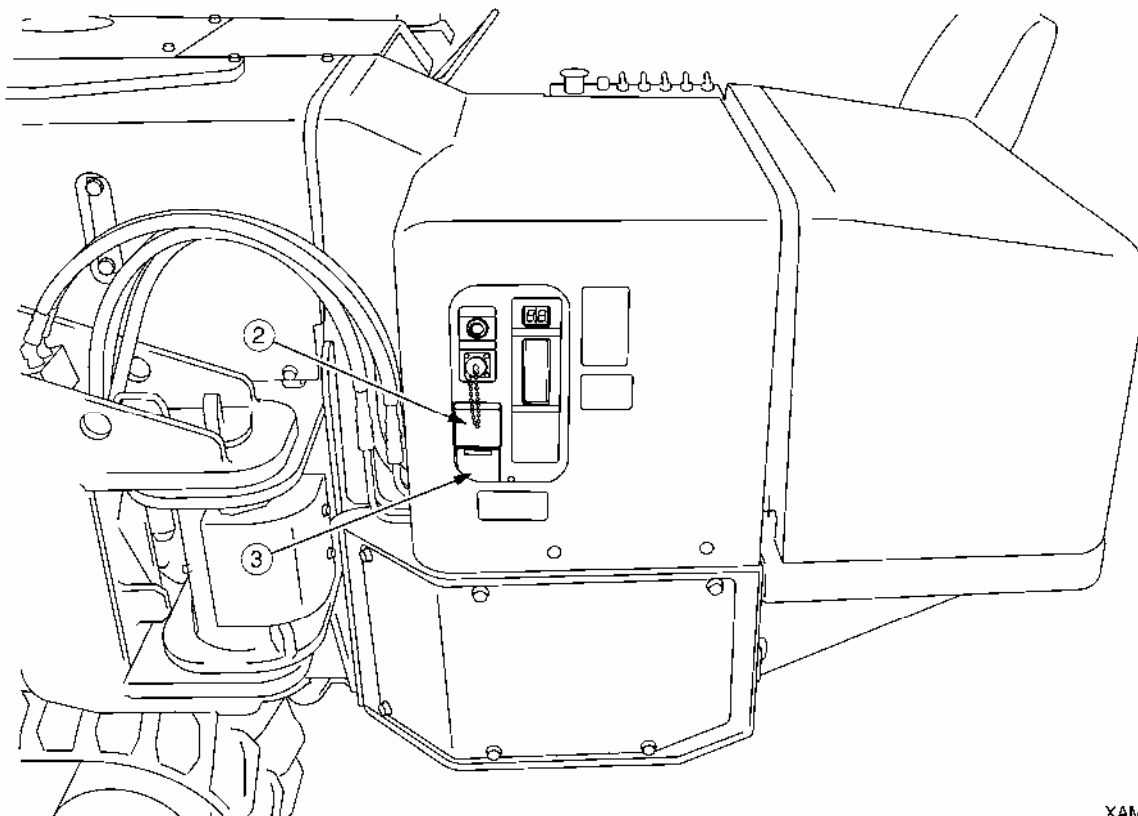

XAM28270

(1) Precautions for remote control (Transmitter) (349-4428500)

**⚠ Rules for Handling** 349-4428500 Read the Instruction Manual carefully before using.

1. Always carry the Portable Rated Load Chart 3. Do not expose transmitter to strong shock such as by dropping it during work and avoid over-loading or tipping over. 4. Avoid direct sun for storing the transmitter.  
2. Never attempt to modify or disassemble this unit. 5. Transmitter or receiver should not be immersed or cleaned in water.

(2) Precautions for remote control (Receiver) (104-4559400)

**⚠ CAUTION**

- Be sure to read the instruction manual.
- Modification or disassembly strictly prohibited.
- Have the power supply turned off whenever radio control or remote control is not in use.
- Direct washing prohibited.
- Cover the receptacle with water-tight cap provided whenever remote control is not in use.

104-4559400

(3) Remote Control Receiver plug caution (Receiver) (300-4214000)

**CAUTION**

1. To insert plug, hold it in line with receptacle guide, push it in, and tighten screw.
2. To pull plug out, do not pull cord, but pull the plug itself. After removing plug, be sure to cover receptacle with water cap.



## 4. COMPONENTS OF THE TRANSMITTER

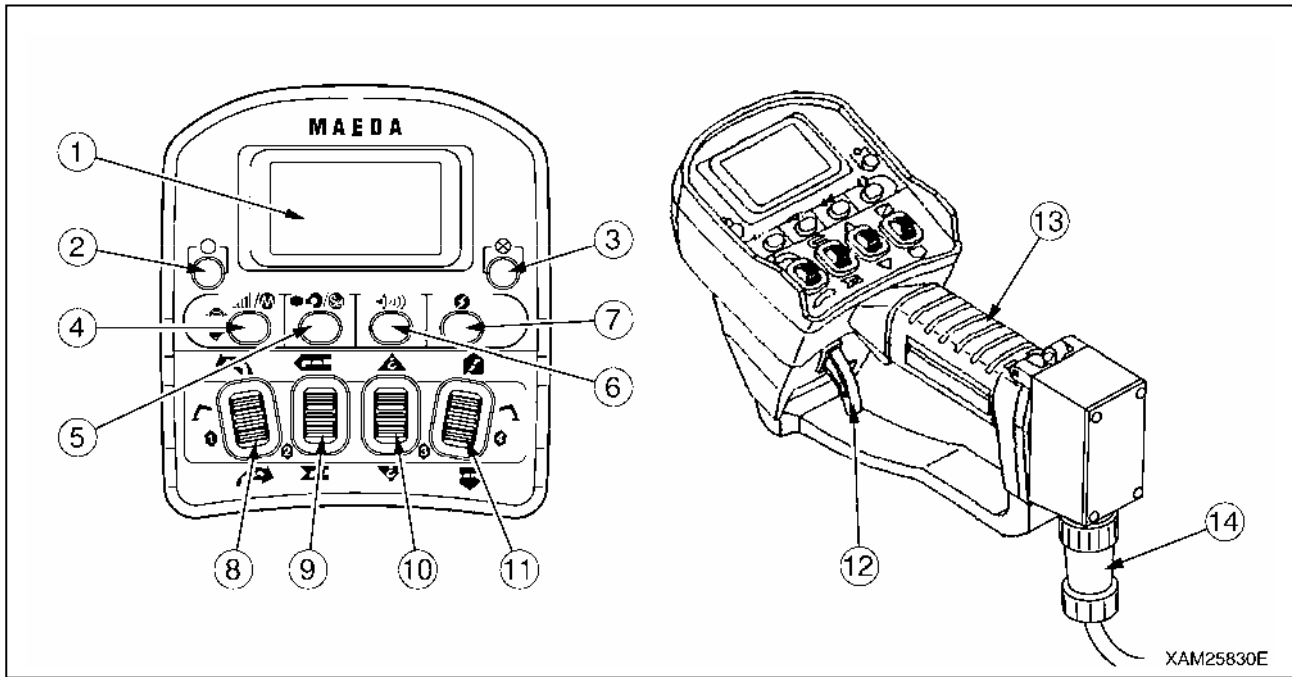

- |                              |   |
|------------------------------|---|
| (1) LCD Screen               | (8) Slewing/No.1 Outrigger Operation Lever                    |
| (2) Start/Reset Button       | (9) Boom Telescoping/No.2 Outrigger Operation Lever           |
| (3) Stop/EMO Button          | (10) Hook Raising and Lowering/No.3 Outrigger Operation Lever |
| (4) Speed/Mode Button        | (11) Boom derricking/No.4 Outrigger Operation Lever           |
| (5) Hook Stow/Setting Button | (12) Accelerator Lever  |
| (6) Horn Button              | (13) Grip   |
| (7) Power Switch             | (14) Connection Cable   |

### CAUTION

The remote control system provides flowing safety functions:

- **Abnormal Signal Detector Circuit**

When the Main switch of the Receiver is turned ON this circuit checks the dispatch of Crane operation signals for 3 to 4 seconds. Thus, the Crane will not be immediately ready for operations.

When dispatch of any crane operation signals are noticed, power will be automatically OFF and the Crane stops.

For resume, push the Reset button of the Transmitter.

- **Automatic Power OFF Circuit**

Power of the Transmitter will be automatically OFF when the remote control of crane operations is discontinued for the specific time.

For resume, push the Power switch of the Transmitter to turn ON.

- **Voltage Drop Limiter (for the Receiver)**

The Receiver will be automatically shut down in the event where the voltage of the battery drops below DC 7 volts.

This prevents malfunctions of the Crane due to voltage drop and the operation will resume automatically when the voltage is restored to DC 7 volts or higher.

### [1] LCD SCREEN (1)

The LCD screen displays the status of the Transmitter in operation, the established values for each mode, or error messages by symbols, comments or signs.

### [2] START/RESET BUTTON (2)

This button has two usages as below:

- To push this button starts the engine.
- This button resets the “Emergency Stop” and “Abnormal Signal Detect” conditions.

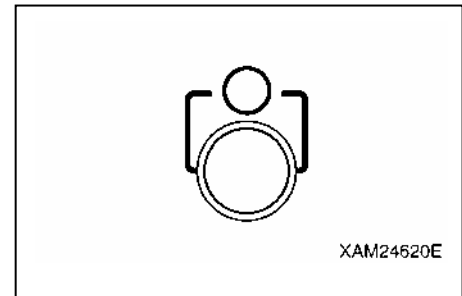

### [3] STOP/EMO BUTTON (3)

This button also has two usages as below:

- To push this button stops the engine.
- In an emergency event where the Crane does not stop by normal operations, or such, this button provides the forced stop function.

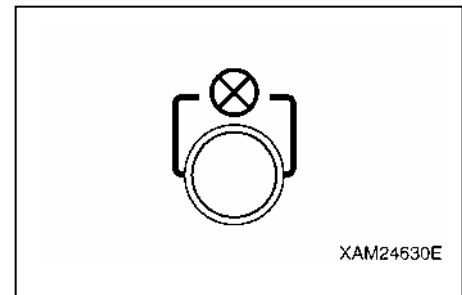

### [4] SPEED/MODE BUTTON (4)

This button also provides two usages as below:

- During crane operations, to push this button decelerates the operation speed.
- During the crane operation is in a pause, this button provides the selection of the Transmitter operation modes.

The current active mode will be displayed in the LCD screen.

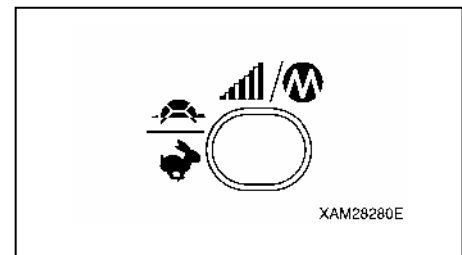

### [5] HOOK STOW/SETTING BUTTON (5)

This button also serves two usages as below:

- To push this button automatically stows the hook.
- For each of the setting of the modes, use this button to fix to one of the choice from the menu in the LCD screen.

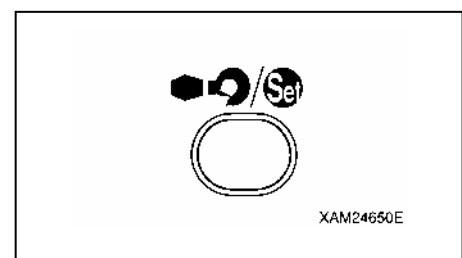

### [6] HORN BUTTON (6)

Push this button to toot the horn.

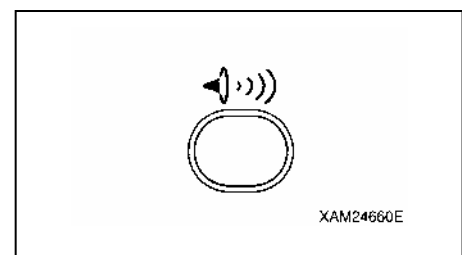

### [7] POWER SWITCH (7)

To push this button switches ON and OFF the power of the Transmitter. Each push will turn ON or OFF alternately.

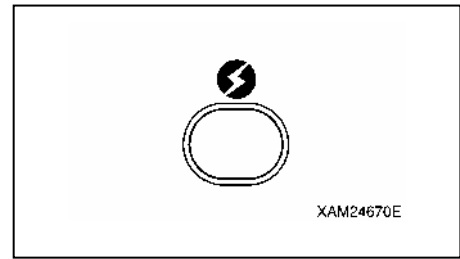

### [8] SLEWING/No.1 OUTRIGGER OPERATION LEVER (8)

This operation lever functions in two ways as below:

1. In the CRANE MODE, this lever controls slew of the Crane structure:
  - Counterclockwise: Push the upper end of the lever.
  - Neutral: Release your finger from the lever.
  - Clockwise: Push the lower end of the lever.
2. In the OUTRIGGER MODE, this lever controls extension (setting) and retraction (stowing) of either only No.1 or all of the outriggers at once:
  - Retraction (stowing): Push the upper end of the lever.
  - Neutral: Release your finger from the lever.
  - Extension (setting): Push the lower end of the lever.

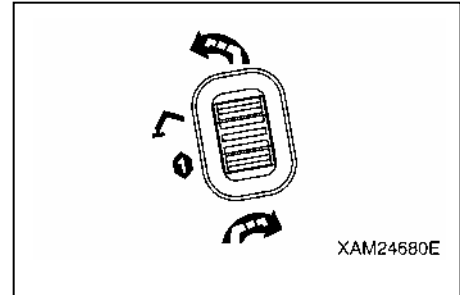

### [9] BOOM TELESCOPING/No.2 OUTRIGGER OPERATION LEVER (9)

This operation lever functions in two ways as below:

1. In the CRANE MODE, this lever controls the telescopic boom length:
  - Boom extension: Push the upper end of the lever.
  - Neutral: Release your finger from the lever.
  - Boom retraction: Push the lower end of the lever.
2. In the OUTRIGGER MODE, this lever controls extension (setting) and retraction (stowing) of either only No.2 or all of the outriggers at once:
  - Retraction (stowing): Push the upper end of the lever.
  - Neutral: Release your finger from the lever.
  - Extension (setting): Push the lower end of the lever.

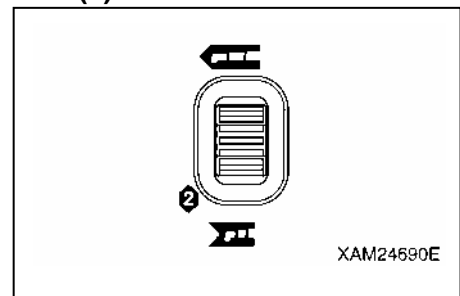

## [10] HOOK RAISING AND LOWERING/No.3 OUTRIGGER OPERATION LEVER (10)

This operation lever functions in three ways as below:

- In the CRANE MODE, this lever controls raising and lowering the hook:
  - Hook raising: Push the upper end of the lever.
  - Neutral: Release your finger from the lever.
  - Hook Lowering: Push the lower end of the lever.
- In the OUTRIGGER MODE, this lever controls extension (setting) and retraction (stowing) of either only No.3 or all of the outriggers at once:
  - Retraction (Stowing): Push the upper end of the lever.
  - Neutral: Release your finger from the lever.
  - Extension (setting): Push the lower end of the lever.
- In the A MODE, this lever is used as a cursor key by “▲ and ▼”.

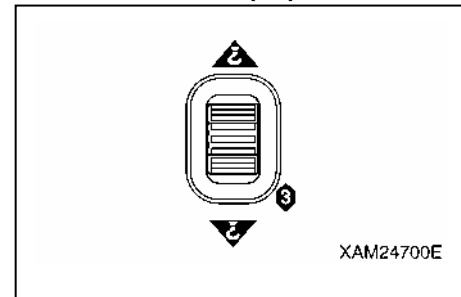

## [11] BOOM DERRICKING/No.4 OUTRIGGER OPERATION LEVER (11)

This operation lever functions in two ways as below:

- In the CRANE MODE, this lever controls the boom derricking angle:
  - Boom raising: Push the upper end of the lever.
  - Neutral: Release your finger from the lever.
  - Boom lowering: Push the lower end of the lever.
- In the OUTRIGGER MODE, this lever controls extension (setting) and retraction (stowing) of either only No.4 or all of the outriggers at once:
  - Retraction (stowing): Push the upper end of the lever.
  - Neutral: Release your finger from the lever.
  - Extension (setting): Push the lower end of the lever.

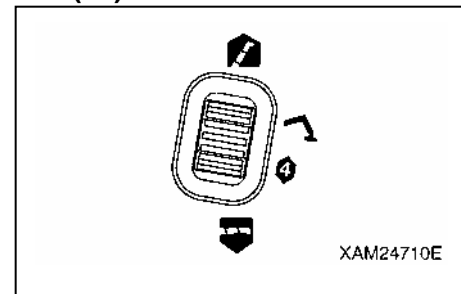

## [12] ACCELERATOR LEVER (12)

The Accelerator lever controls the flow rate of the control valves and the engine speed or output.

- Low idling: Release your finger from the Accelerator lever.
- Full throttle: Squeeze the accelerator lever to the full.

### NOTES

- The Accelerator lever itself cannot control either flow rate of the control valves or the engine speed when it is manipulated alone. In the condition that any of the other operation levers are also used, the Accelerator lever launches specified operation of the Crane in the idling state of the engine, when it is manipulated, then, the engine speeds up by further manipulation of it; the crane operation turns to be faster, accordingly.
- The Accelerator lever does not control outriggers.
- The acceleration rate is always indicated in the right part of the LCD screen during crane operations. (See the figure in the right.)

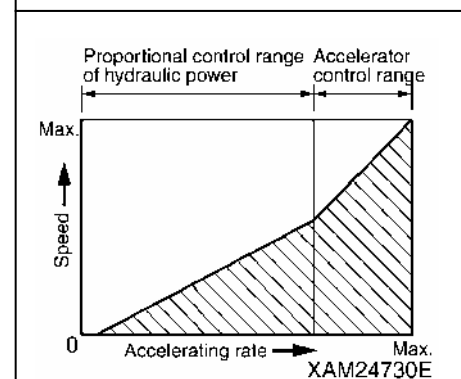
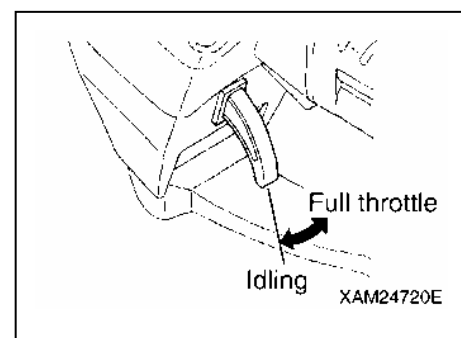



### [13] GRIP (13)

The Transmitter is designed for one hand controls in general. Levers and buttons can be manipulated by your thumb, while the accelerator lever can be triggered by your forefinger. Other fingers should grab the grip to hold the Transmitter.

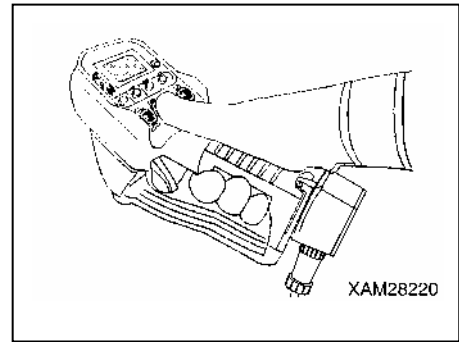

### [14] CONNECTION CABLE (14)

The connection cable is a cable between the Transmitter and Receiver.

Before and after the operation, always check this connection cable for any crack or damage, or bent. In addition, check the receptacle for any damage.

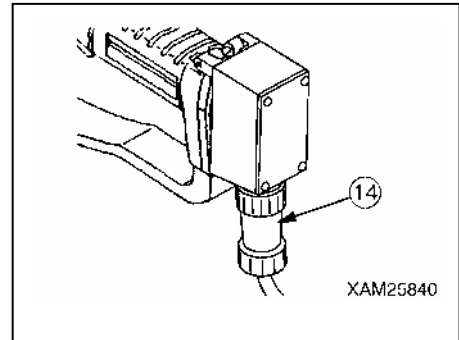

### [15] STORAGE CASE (15)

The Storage case is a compact bag for protection of the Transmitter.

Before putting it into this case, ensure that the power of the Transmitter is OFF.

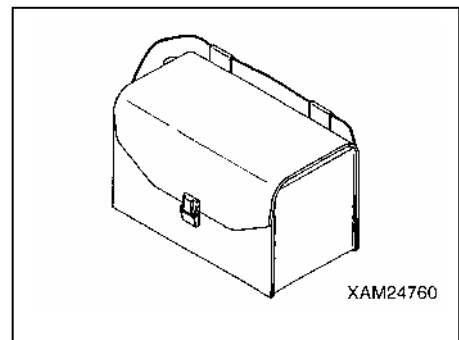

### [16] HOOK BELT (16)

During the operation, this belt prevents the Transmitter from falling down to the ground, when the operator drops it by mistake.

Hook one end of the hook belt (16) to the Transmitter and attach another end to the operator's waist belt, or such.

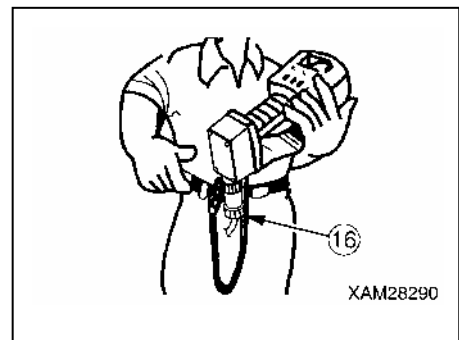



## 5. COMPONENTS OF THE RECEIVER

### 5.1 COMPONENTS OF THE RECEIVER

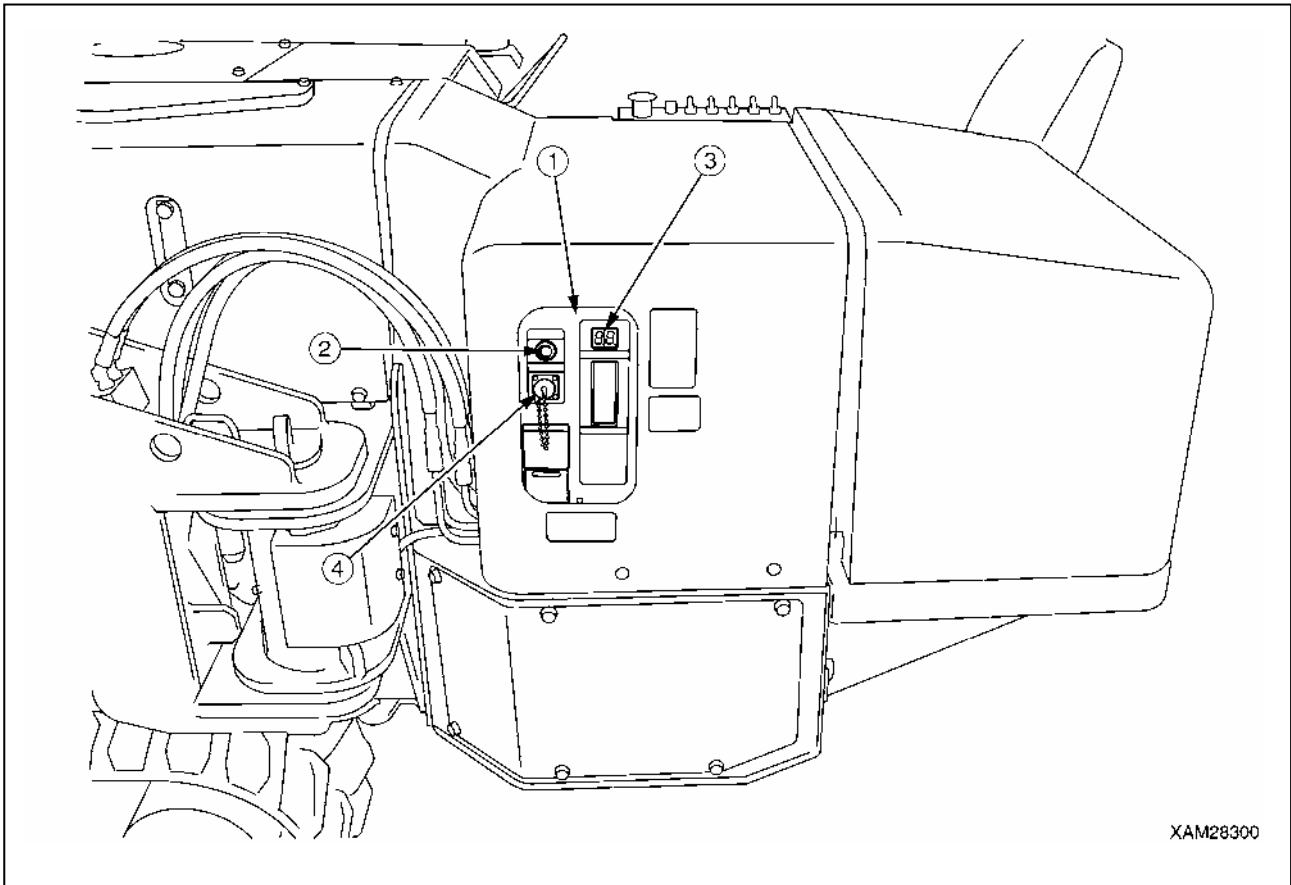

- (1) Control Box  
(2) Main Switch

- (3) Monitor Display  
(4) Receptacle

### CAUTION

The remote control system provides flowing safety functions:

- **Abnormal Signal Detector Circuit**

When the Main switch of the Receiver is turned ON, this circuit checks the dispatch of crane operations signals for 3 to 4 seconds. Thus, the Crane will not be immediately ready for operations.

When dispatch of any crane operation signals are noticed, power will be automatically OFF and the Crane stops. For resume, push the Reset button of the Transmitter.

- **Automatic Power OFF circuit**

Power of the Transmitter will be automatically OFF when the remote control of the crane operation is discontinued for the specific time.

For resume, push the Power switch of the Transmitter to turn ON.

- **Voltage Drop Limiter (for the Receiver)**

The Receiver will be automatically shut down in the event where the voltage of the battery drops below DC 7 volts.

This prevents malfunctions of the Crane due to voltage drop and the operation will resume automatically when the voltage is restored to DC 7 volts or higher.

### [1] CONTROL BOX (1)

The Control box contains the receiver devices and control devices.  
Never attempt to dismantle this Control box.

### [2] MAIN SWITCH (2)

The Main switch is a toggle switch to power ON or OFF the Receiver

- ON : Turn the toggle to ON to start the Receiver.
- OFF: Turn the toggle to OFF to terminate the Receiver.

#### CAUTION

- Before starting the engine, always turn this Main switch of the Receiver to OFF.
- Where the remote control is not in use, always turn the main switch of the Receiver to OFF.

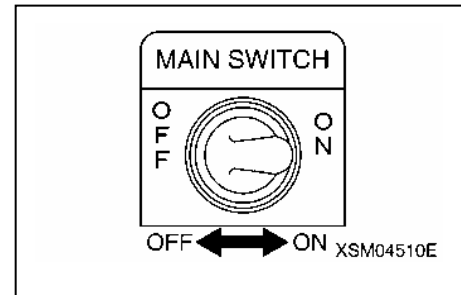

### [3] MONITOR DISPLAY (3)

In the event that the abnormal signal detector of the controller serves, the Monitor display indicates error codes.

#### CAUTION

In the event that the monitor display (3) indicates an error code, settle the error as follows:

1. Push the Reset button of the Transmitter.
  2. When the practice as above 1. results another error code, once turn the Receiver OFF, then start it again.
  3. When the practice as above 2. results further error code, it is suspected that the Transmitter or Receiver has faults; contact us or our agents for services.
- ★ For detail of error codes, refer to "10. TROUBLE SHOOTING".

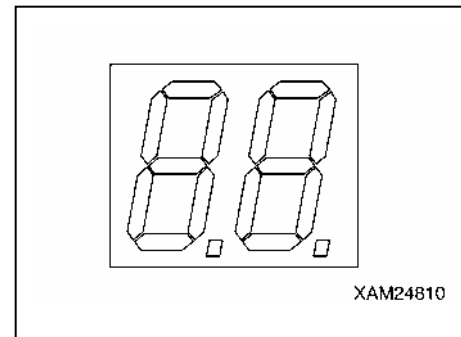

### [4] RECEPTACLE (4)

Connect the connection cable from the Transmitter, here.

#### CAUTION

- Before attaching the connection cable to the receptacle (4), always confirm that the Main switch (2) is in the OFF position.  
After the insertion, secure the plug by the screw.
- Always apply the water proof cap while the remote control is not in use.
- In the condition where the remote control is not provided, this receptacle (4) is incompetent. Always keep the water proof cap attached.

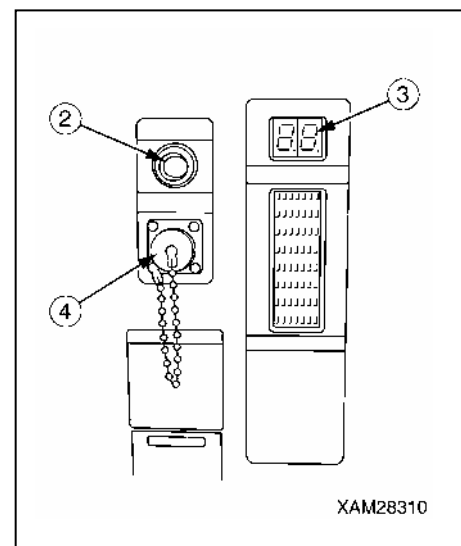

## 5.2 FUSE IN THE RECEIVER

### ⚠ CAUTION

- For any tests or replacement of a fuse, always turn OFF the Main switch of the Control box, before removing it.
- The fuse must be replaced with the same type of grass tube fuses, and of the same rating.

### CAUTION

A fuse is inserted in the (+) line of the main power supply of the Receiver as a protective circuit of internal devices and prevents circuits from burnt.

- A grass tube fuse is employed. In the event where the fuse is corroded and shows white rust, or when a loose condition is recognized, always replace it with a new one.
- When the fuse is blown, never fail to examine the circuit for the cause and repair it before replace the fuse.
- The fuse must be replaced with the same type of grass tube fuses, and of the same rating.

The fuse is placed inside the Receiver.

Test and replacement of the fuse shall be practiced as follows:

- Use the following hand tools:
  - A screw driver (Philips)
  - Jewelers screw driver set (Slotted)
  - General hand tools, used to detach the cover of the control box.

#### [1] REMOVAL OF THE FUSE

1. Detach the cover (1), (2) of the Control box so that the cover of the Receiver can be detached.
2. Unfasten eight of screws (4) and take away the cover of the Receiver (3).

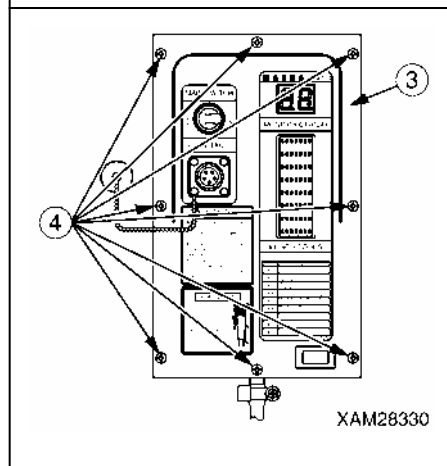
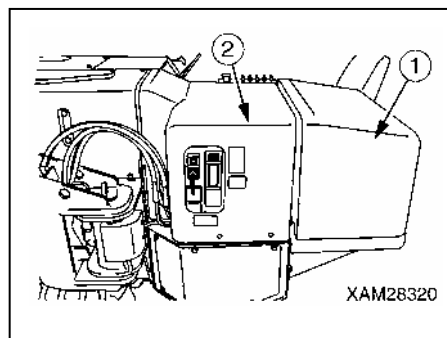

3. Extract three of connectors (6) in the first PCB (5).

4. Unfasten six of screws (7) and remove the first PCB (5).

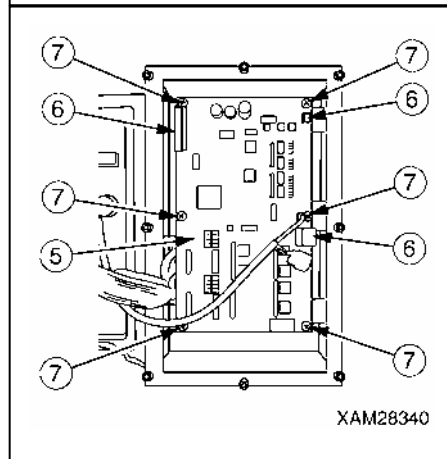

5. With a jeweler's driver (A) to pull out the fuse (8) from its clips, then examine it.

6. Insert a new fuse or the examined fuse to where the one was.

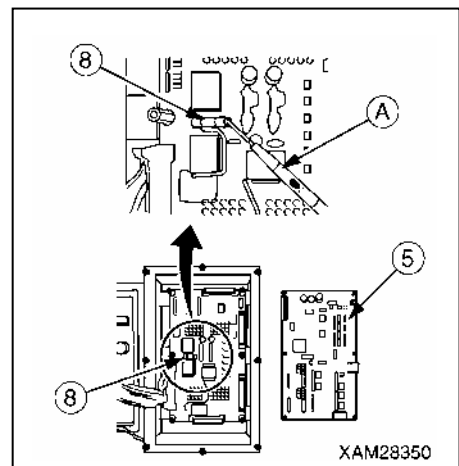

## [2] INSERTION OF A FUSE

After the fuse is examined or replaced, restore the Receiver in the reverse practice of the removal.

### CAUTION

- When the three connectors (6) of the first PCB (5) is inserted again, secure them and avoid any loose conditions.
- Care should be exercised so that the cover (3) of the Receiver will not catch wires when it is attached back.

### [Fuse class]

Type : Grass tube fuse

Rating: 15A

## 6. MODE SETTING OF THE TRANSMITTER

This device provides the “A MODE” in which the initial values of the Transmitter are established, the “OUTRIGGER MODE” in which the outriggers are set or stowed, and the “CRANE MODE” where the Crane is operated. This device is designed to switch to the applicable mode for the operation by the Transmitter.

### 6.1 A MODE

#### ⚠ WARNING

- Before entering into A MODE, always turn the main switch of the Receiver to the OFF position.
- Before the setting of values for A MODE, ensure that “A MODE” is correctly indicated in the LCD screen. Otherwise, un-expected motion of the Crane may result a serious accident, due to entry of values in the other mode, by mistake.

#### 6.1.1 OPENING A MODE SCREEN

Push the Speed/Mode button and Power switch jointly for 2 seconds. A message as “A MODE” appears in the LCD screen for 2 seconds.

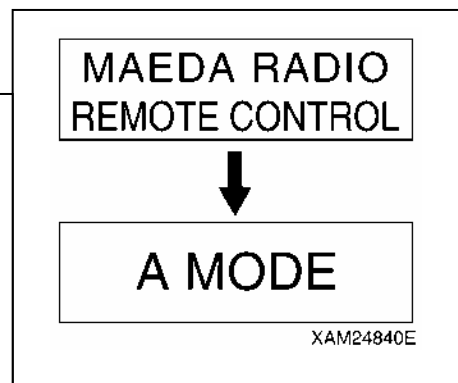
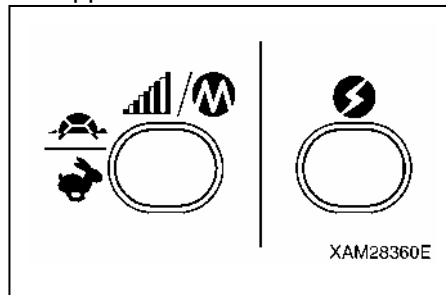

#### 6.1.2 MESSAGES IN THE A MODE SCREEN

Refer to the figure in the right for the A MODE screen: It contains eight function items ((1) to (8)) and the Exit command ((9)).

| NOTES  |  |
|--|--|
| In the A MODE, following applicable items are adjustable, as required: |  |
| (1)  | “Contrast ratio” of LCD screen   |
| (2)  | “Loudness control”   |
| (3)  | The “Engine speed limit”, controllable by the Accelerator lever.                                 |
| (4)  | LCD backlight, “Time for lighting, until the auto-cut”.  |
| (5)  | “Auto Shut-OFF time” of the Transmitter power.   |
| (6)  | “Low idling rate” of the engine. (Idling only while the crane operation levers are manipulated.) |
| (7)  | Reset of “user values” by the speed set-up mode.   |
| (8)  | Version information of the Transmitter firmware.   |

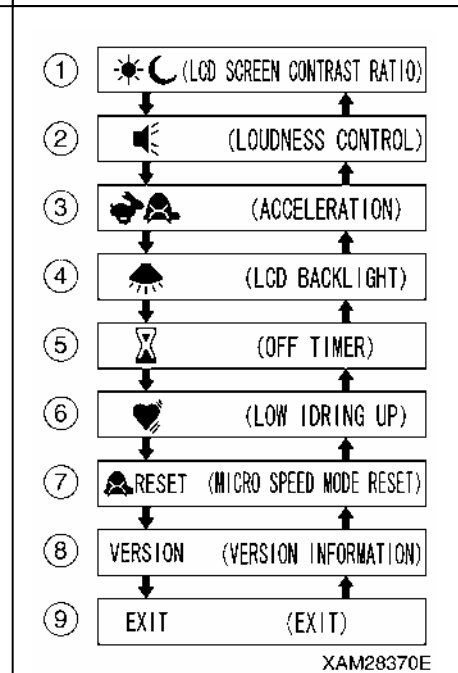

To switch the function item to another, or to change the setting value of the function, use, the Hook raising and lowering lever. Then, to fix the value in the function, push the hook Stow/Setting button.

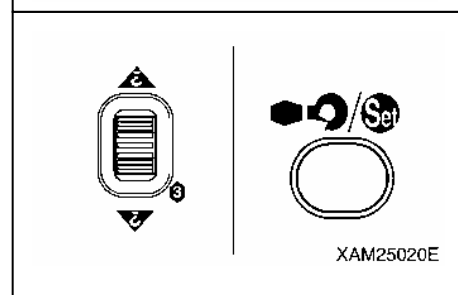

## [1] LCD SCREEN CONTRAST RATIO

### CAUTION

The LCD screen may be illegible when it is set too light or too dark, which may prevent correct operations. Adjust its contrast adequately for comfortable read.

Adjust the contrast ratio of the LCD screen:

- Shift the cursor (▲ or ▼) using the Hook raising and lowering lever.
  - To darken: Push the upper end of the Hook raising and lowering lever.
  - To lighten: Push the lower end of the Hook raising and lowering lever.
- When the desired contrast is obtained, push the Hook stow/Setting button. The condition obtained in above 1. will be fixed and the display returns to the A MODE screen.

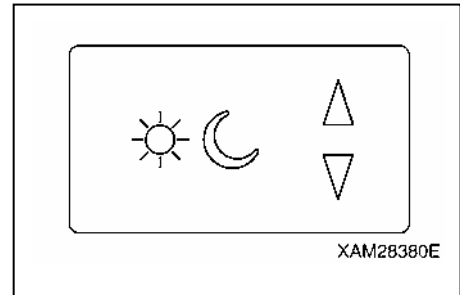

## [2] LOUDNESS CONTROL (available only for units with optional voice message)

Adjust the volume of voice messages:

- Shift the cursor (▲ or ▼) using the Hook raising and lowering lever and select the appropriate rate.

The volume adjust is by 6 steps, OFF, 1, 2, 3, 4, or ON.  
The factory setting for this function is "MAX".
- When the desired volume is obtained, push the Hook stow/Setting button. The condition obtained in above 1. will be fixed and the display returns to the A MODE screen.

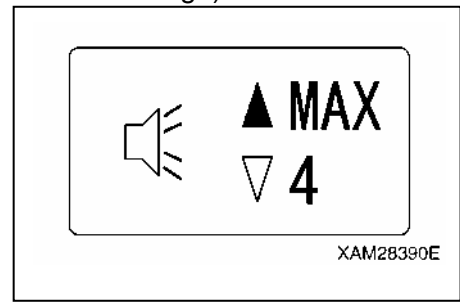

## [3] ACCELERATION

Adjust the engine speed limit, controllable by the Accelerator lever:

- Shift the cursor (▲ or ▼) using the Hook raising and lowering lever. When all the bars lights, the speed limit is in maximum, otherwise, when the all are OFF, it is in minimum.
- When the suitable rev limit is obtained, push the Hook stow/Setting button. The value obtained in above 1. will be fixed and the display returns to the A MODE screen.

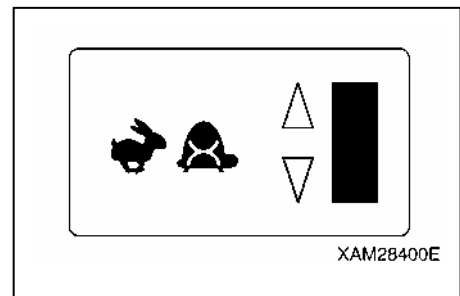

## [4] LCD BACKLIGHT

Adjust the time to the auto-cut of the LCD backlight, after your finger is released from each of the lever.

- Shift the cursor (▲ or ▼) using the Hook raising and lowering lever and select the preferred time.

The elapse time adjust is by 4 steps, OFF, 1 sec., 3 sec., or 4 sec.  
The factory setting for this function is "1 second".
- When the desired time is obtained, push the Hook stow/Setting button. The elapse time in above 1. will be fixed and the display returns to the A MODE screen.

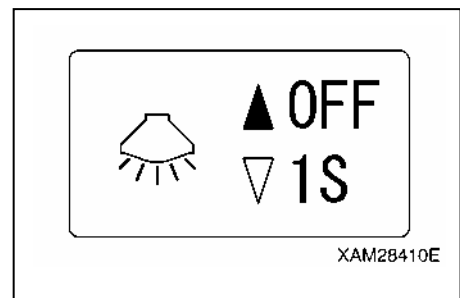



### [5] OFF TIMER

Adjust the Auto shut-OFF time of the Transmitter power.

1. Shift the cursor (▲ or ▼) using the Hook raising and lowering lever and select the preferred time.

The Auto shut-OFF adjust is by 3 steps, 5 min., 10 min., or 15min.

The factory setting for this function is "5 minutes".

2. When the desired time is obtained, push the Hook stow/Setting button. The time in above 1. will be fixed and the display returns to the A MODE screen.

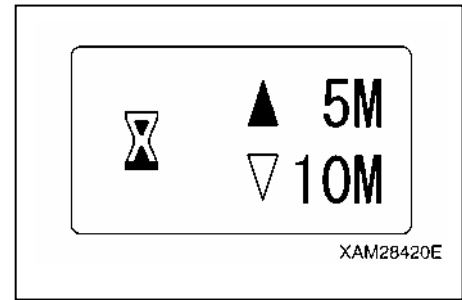

### [6] LOW IDLING UP

#### CAUTION

**The low idling rate regulated by this idling-up function is valid only during crane operation levers are manipulated. Once the lever is released, the low idling rate is reset to the normal rate.**

Adjust the engine's low idling rate to higher than the normal rate, during the crane operation levers are manipulated.

1. Shift the cursor (▲ or ▼) using the Hook raising and lowering lever. When all the bars light, the idling up is in the maximum, otherwise, when the all are OFF, the idling up is canceled.

2. When the suitable idling up rate is obtained, push the Hook stow/Setting button. The value obtained in above 1. will be fixed and the display returns to the A MODE screen.

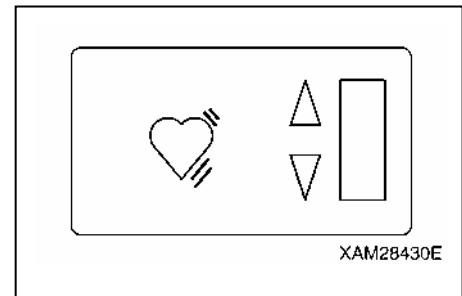

### [7] MICRO SPEED MODE RESET

Select either to reset or preserve the value at the micro speed mode.

1. Shift the cursor (▲ or ▼) using the Hook raising and lowering lever and select "N" or "Y".

To reset, select "Y", otherwise, select "N" to preserve.

2. Whether reset or not is fixed, push the Hook stow/Setting button.

The status in above 1. will be fixed and the display returns to the A MODE screen.

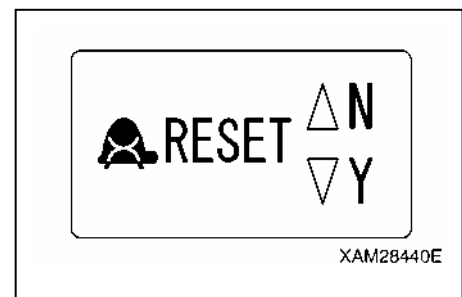

### [8] VERSION INFORMATION

Push the Hook stow/Setting button, so that version information of the Transmitter firmware is displayed. Another push of the same button makes the display returns to the A MODE screen.

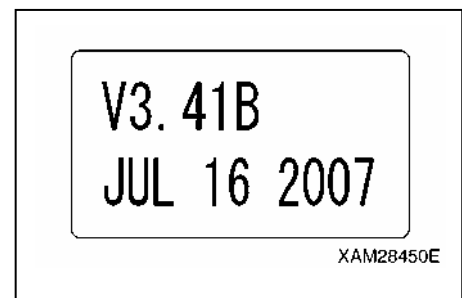

## [9] EXIT

### CAUTION

Once setting-up the desired function items of all is completed, do not forget to practice the termination procedure, below. Otherwise, when this process is not correctly terminated, the latest setting will not become valid.

1. Once setting-up the desired function items of all is completed, ensure that the display has returned to the A MODE screen.
2. Shift the cursor (▲ or ▼) using the Hook raising and lowering lever and select "EXIT".
3. Push the Hook stop/Setting button, which will terminate the "A MODE" and turn the mode to "the "CRANE MODE".

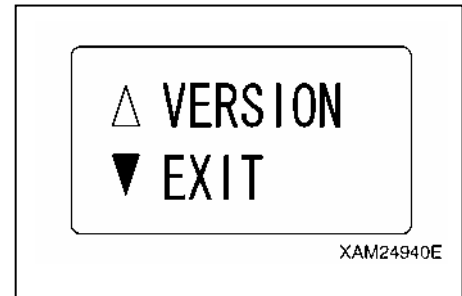

### 6.1.3 AN EXAMPLE FOR SETTING IN THE A MODE

Hereunder is a procedure to change the time of the "OFF timer", from "5 minutes" of the factory setting, to 10 minutes:

1. Use the Hook raising and lowering lever and shift the cursor (▲ or ▼) to the side of the function item to change.

2. When the cursor comes to the side of the "OFF timer", push the Hook stop/Setting button.

Now, the "OFF timer" is selected and the cursor (▲) appears next to "5 minutes", as the current value.

3. Use the Hook raising and lowering lever so that the cursor (▼) comes to the side of "10 minutes", then push the Hook stop/Setting button.

Now, the "OFF timer" setting is 10 minutes.

4. Shift the cursor (▲ or ▼) using the Hook raising and lowering lever and select "EXIT", then push the Hook stop/Setting button. Now the mode exits from the "A MODE" and is turned to the "CRANE MODE".

#### CAUTION

- Once setting-up the desired function item is completed, do not forget to practice the termination procedure, above. Otherwise, when this process is not correctly terminated, the latest setting will not be valid.
- Change of the other function item setting is available by the same procedure. In such event, correctly exit from the A MODE, without fail.

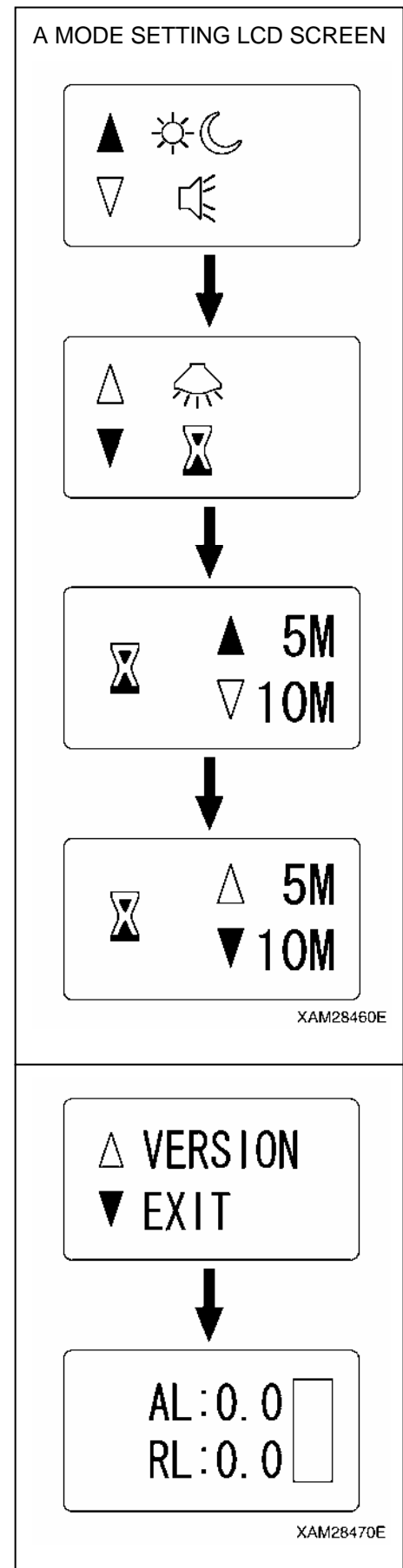

## 6.2 PROCEDURE IN THE OPERATION MODE

### CAUTION

When the Main switch of the Receiver is turned ON, its abnormal signal detector automatically starts, first. Please allow it for 3 to 4 seconds, without using any levers, buttons and the Accelerator lever.

### NOTES

- For changes between the modes, always turn OFF the power, once, then push the Power button again to power ON.
  - While using a mode other than the "CRANE MODE", when you turn OFF the power by the Power switch and turn it ON, again (i.e., you keep waiting for 2 seconds or more), the mode is automatically set to "CRANE MODE".
- When you want to continue the operation in the previous mode, call the appropriate mode, again.

### 6.2.1 CALL OUT CRANE MODE

1. Push the Power button to turn ON the Transmitter.

The "Crane mark" is displayed in the LCD screen for 2 seconds or around.

#### NOTES

In case that the power is already ON, once turn OFF, and then push the Power button again for power ON.

2. When the "Crane mark" in the LCD screen disappears in 2 seconds, the "CRANE MODE" is automatically called out.



XAM24670E



XAM24980E

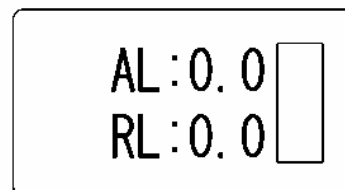

XAM28480E

## 6.2.2 CALL OUT OUTRIGGER MODE

### NOTES

The OUTRIGGER MODE consists of "Extension mode" and "Ground setting mode". Use respective modes as shown below:

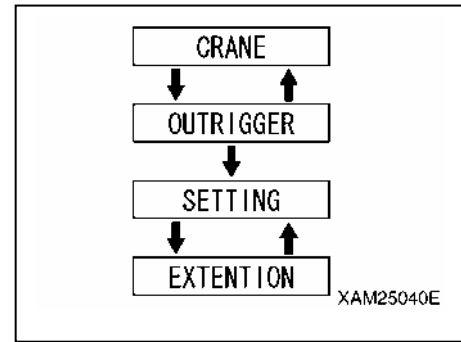

1. Push the Power button to turn ON the Transmitter.

The "Crane mark" is displayed in the LCD screen for 2 seconds around.

### NOTES

In case that the power is already ON, once turn OFF, and then push the Power button again for power ON.

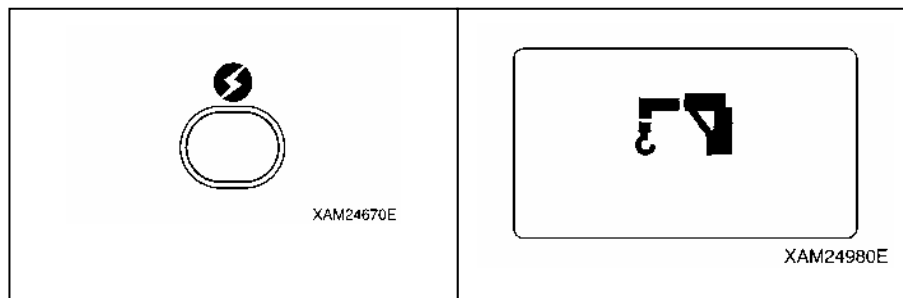

2. While the "Crane mark" is shown in the LCD screen (for approx. 2 seconds), push the Speed/Mode button for 2 seconds.

The LCD provides the screen for selecting "CRANE MODE" or "OUTRIGGER MODE".

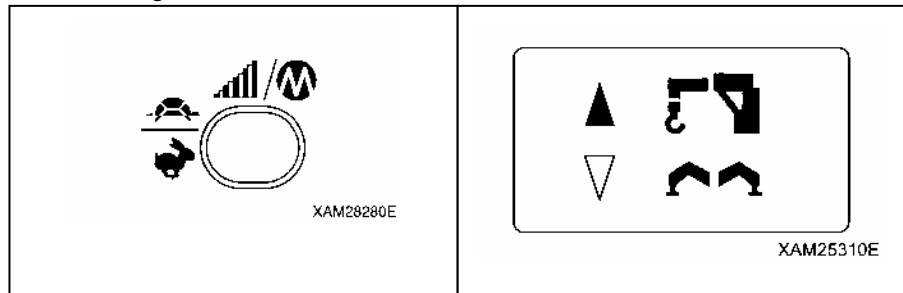

3. Use the Hook raising and lowering Lever and shift the cursor (▲ or ▼), and push the Hook stow/Setting button when the cursor points out the "OUTRIGGER".

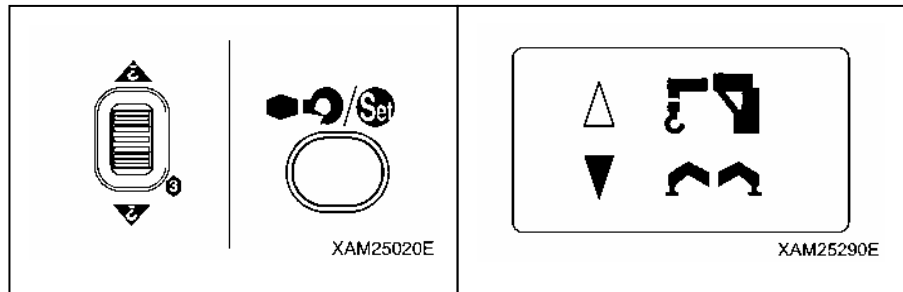

4. The operation mode is already switched to the “OUTRIGGER MODE”, thus the “Outrigger mark” is exhibited.

Soon after, it enters into “Ground setting mode”, then the mark turns to “Ground setting (↑↓)”.

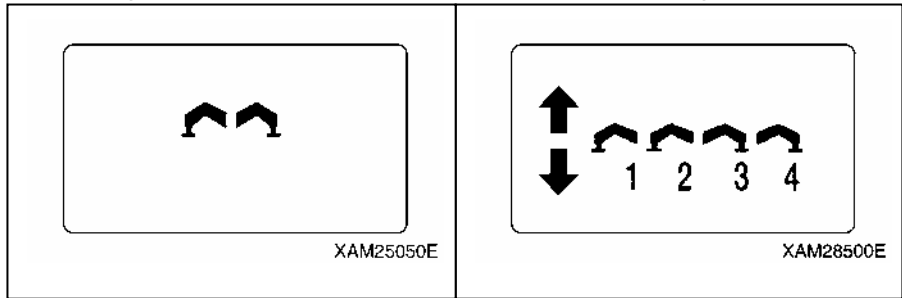

5. To shift to “Extension mode”, push the Speed/Mode button, while the LCD screen shows the “Ground setting mode”. Then the mode is switched to “n”; the mark turns to “Extension (←→)”.

**NOTES**

Switching between “Outrigger Extension mode” and “Outrigger Ground setting mode” is alternately by each push of the Speed/Mode button.

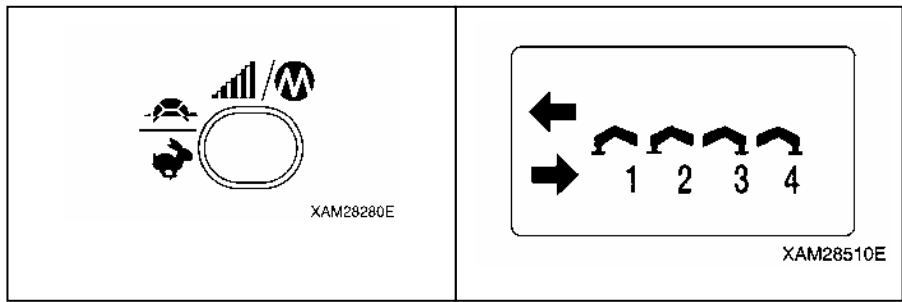

## 7. CHECKING BEFORE OPERATION

### **⚠ WARNING**

Precautions shown in this section must be practiced prior to the day's work, without fail. Serious injury or death may arise when these checking are neglected. Further, refer to the section of "OPERATION 2.1 Checking before Operation" for the checking of the crane structure. In the event where any failure is revealed in such checking, repair it, or contact us or our agents for services.

### 7.1 CHECKING BEFORE STARTING ENGINE

#### 7.1.1 CHECKING BEFORE TURNING ON THE TRANSMITTER

### **⚠ WARNING**

For the Checking before Turning ON the Transmitter, ensure that the engine starter key is in the OFF position, as well as the Receiver main switch is OFF. Otherwise, the engine may un-expectedly starts and cause serious injury or death, while checking the Transmitter.

Perform the following inspections while the Transmitter power is OFF:

- Check the control levers, operation buttons, LCD screen, Accelerator lever and Grip for oily dirt or other soil.

Scrub away the dirt with a clean cloth or such, when any.

- Check for foreign bodies such as particles of small stone or sand, caught into small openings in the vicinity of the control levers and/or Accelerator lever.

Remove such particles completely, when any. In the event where such particles are caught in the small openings in the vicinity of the control levers and/or acceleration lever, they may disturb correct operations and cause un-expected motion of the Crane which results a serious accident.

- Check for any cracks and/or damage to the Transmitter enclosure, or impairment to the rubber cover of the operation levers and control buttons.

Repair such cracks or damage immediately, when any.

Such cracks or damage may allow water to enter inside and brings troubles or failures to the Transmitter and cause a serious hazard.

- Check the smooth and correct actions of each of the operation lever and control button, and the Accelerator lever, as well as they smoothly return to the each neutral position when the finger is released. Repair the operation levers, Accelerator lever and/or control button without delay, when any of them show an incorrect action.

Any failure to the operation levers, Accelerator lever and/or control button brings troubles or failures and cause a serious hazard.

- Check the connection cable for any cracks, damages and/or bents, or loose connection or damage in the connector section.

Repair or replace to a new cable, where such cracks, damages, or loose connection is present.

### 7.1.2 CHECKING AFTER TURNING ON THE TRANSMITTER

At the moment when the Transmitter is powered ON, make checks on following items:

#### [1] VERIFICATION OF THE LCD SCREEN SIGN AT POWER-ON

Push the Power switch to turn ON the Transmitter.

At this moment, confirm the mark as shown below, in the LCD screen.

| NOTES   |
|---|
| In two seconds of this condition, it automatically enters into the "CRANE MODE" . |

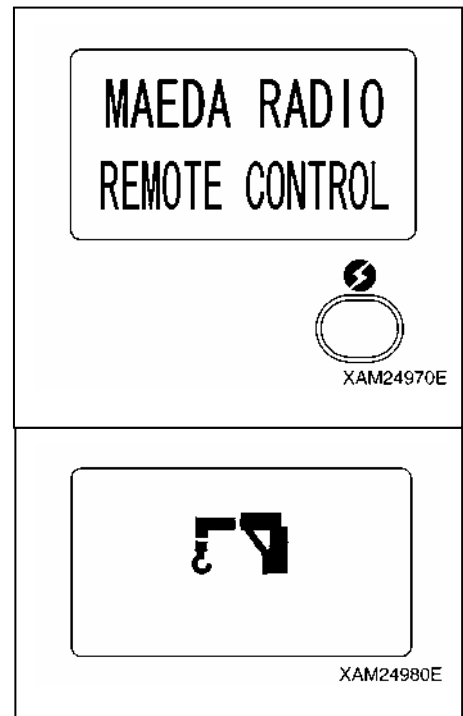

#### [2] VERIFICATION OF THE LCD SCREEN SIGN AT THE "CRANE MODE"

1. Compare the corresponding values in the Transmitter and Moment limiter, i.e. "AL" to "Actual Load", "RL" to "Rated Load", and the "bar chart (in the right)" to "Load Factor", to verify each is identical.
2. Manipulate each control button and verify that each indication in the LCD screen is correct.
3. Verify that "START" is correctly displayed in the LCD screen when the Start/Reset button is pushed.
4. Also, verify that "STOP" is correctly displayed in the LCD screen when the Stop/EMO button is pushed.

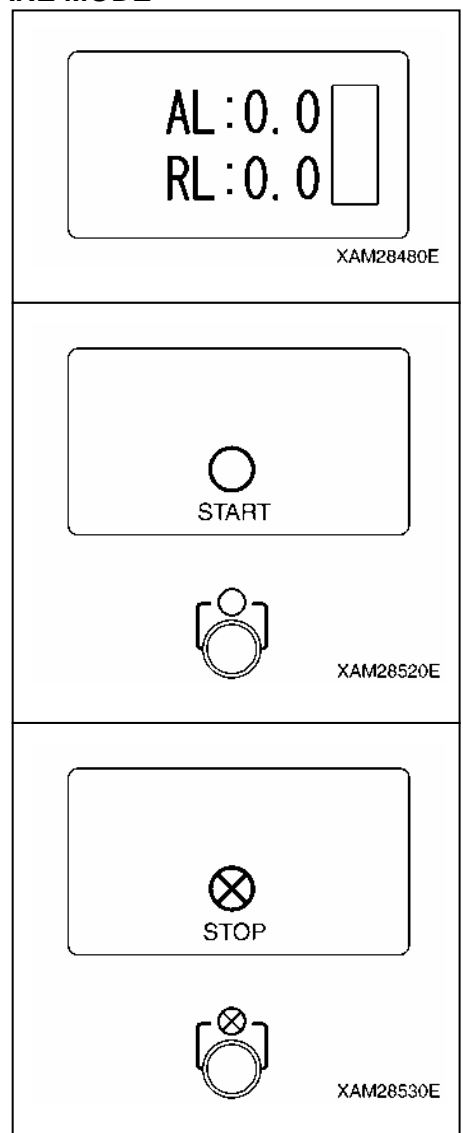



**[3] VERIFICATION OF THE LCD SCREEN SIGN AT THE “OUTRIGGER MODE”**

1. Push the Power switch to once turn OFF the Transmitter.
2. Push the Power switch again to turn ON the Transmitter.  
The “Crane mark” is displayed in the LCD screen for 2 seconds around.

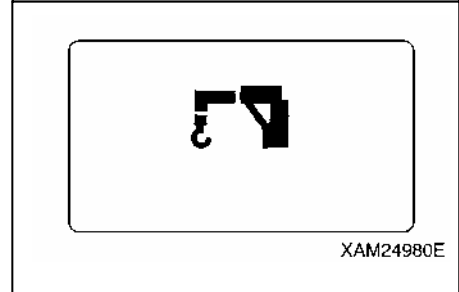
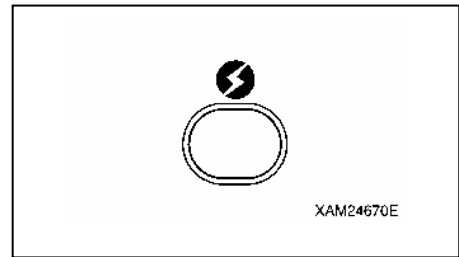

3. While the “Crane mark” is shown in the LCD screen (for approx. 2 seconds), push the Speed/Mode button for 2 seconds.

The LCD provides the screen for selecting “CRANE MODE” or “OUTRIGGER MODE”.

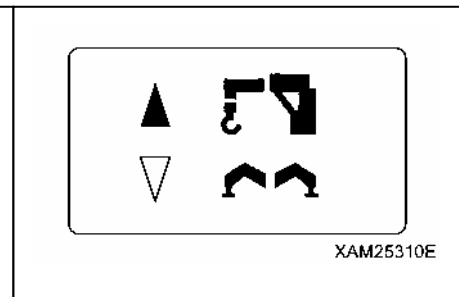
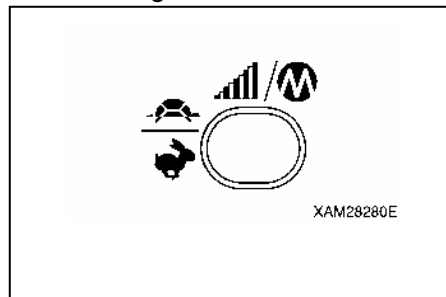

4. Use the Hook raising and lowering Lever and shift the cursor (▲ or ▼), and push the Setting button when the cursor points out the “OUTRIGGER”.

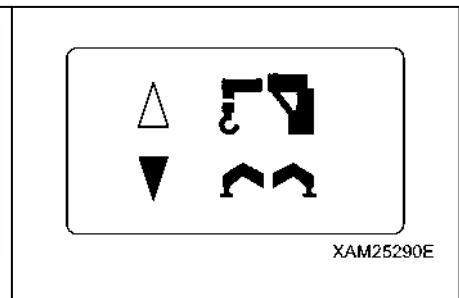
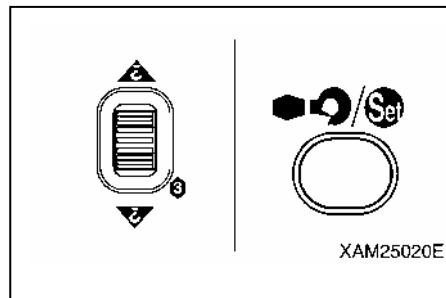

Here, confirm that the “Outrigger mark” is exhibited, then it enters into the “Ground setting mode”, soon after.

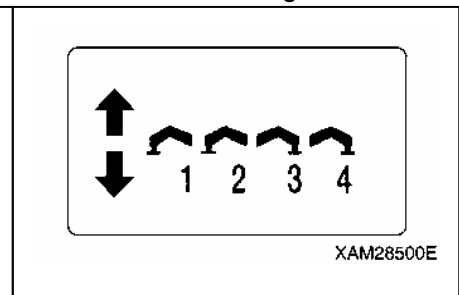
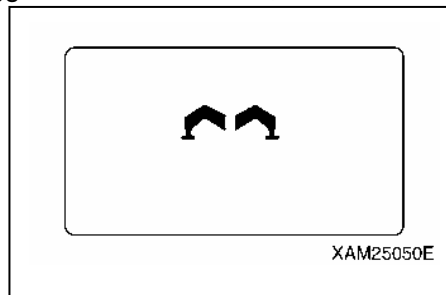

5. Manipulate each operation lever and verify that each indication in the LCD screen is correct.

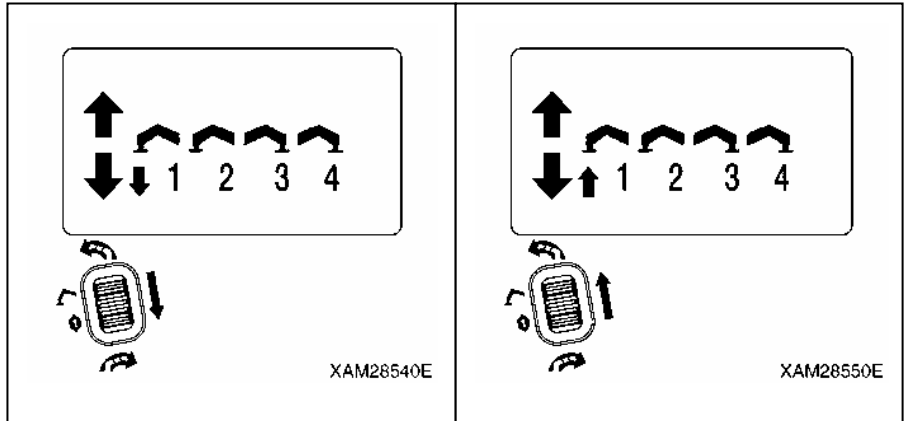

6. To shift to “Extension mode”, push the Speed/Mode button, while the LCD screen shows the “Ground setting mode”.

Here, confirm that the “Outrigger Extension mode” is exhibited.

**NOTES**

Switching between “Outrigger Extension mode” and “Outrigger Ground setting mode” is alternately by each push of the Speed/Mode button.

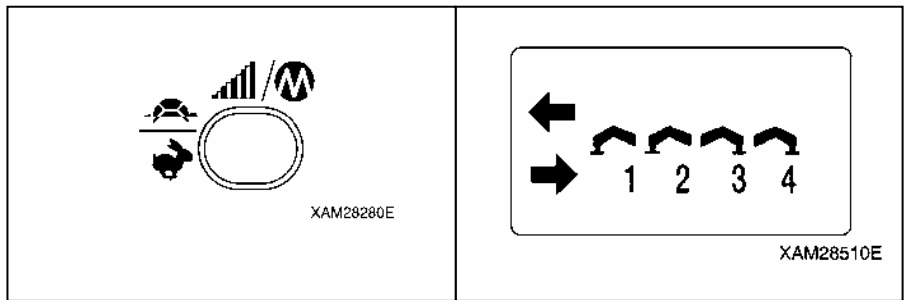

7. Manipulate each operation lever and verify that each indication in the LCD screen is correct.

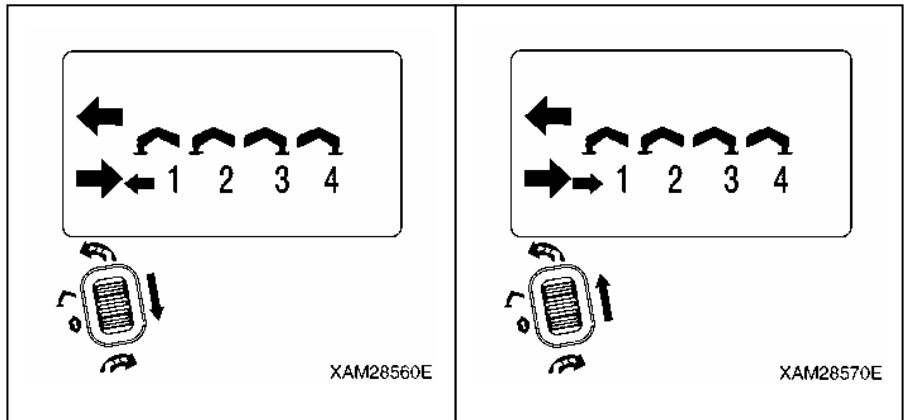

### 7.1.3 CHECKING RECEIVER

Perform the following inspections:

- Check the Control Box (1), Main Switch (2), Monitor display (3), and Receptacle (4) for oily dirt or other soil.

Scrub away the dirt with a clean cloth or such, when any.

- Check for any cracks and/or damages to the Control Box (1) or Monitor display (3). Repair such cracks or damage immediately, when any.

Such cracks or damages may allow water to enter inside and brings troubles or failures to the Receiver, then cause a serious hazard.

- Check the Main switch (2) and Receptacle (4) for the loose conditions or damages.

Repair immediately when such loose conditions or damages are found.

Such loose conditions or damages may cause errors or faults of the Receiver, which results a serious hazard.

- Toggle the Main switch (2) to ON and OFF alternately to verify that power is correctly turned ON or OFF.

- Turn ON the Transmitter, then toggle the Main switch (2) to ON, in addition, and confirm next that the two dots in the Monitor display as shown in the figure in the light blink.

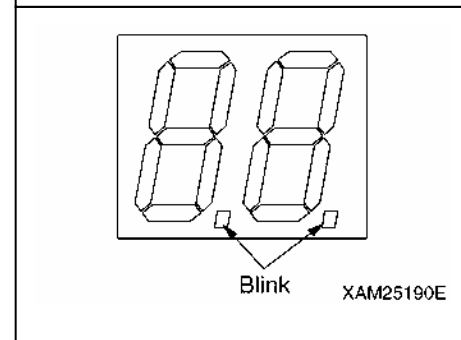
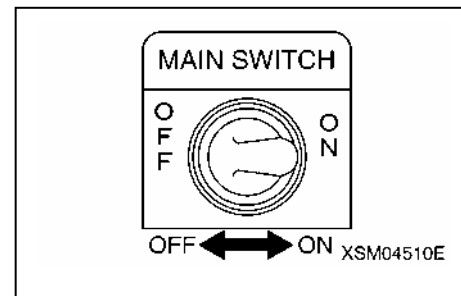
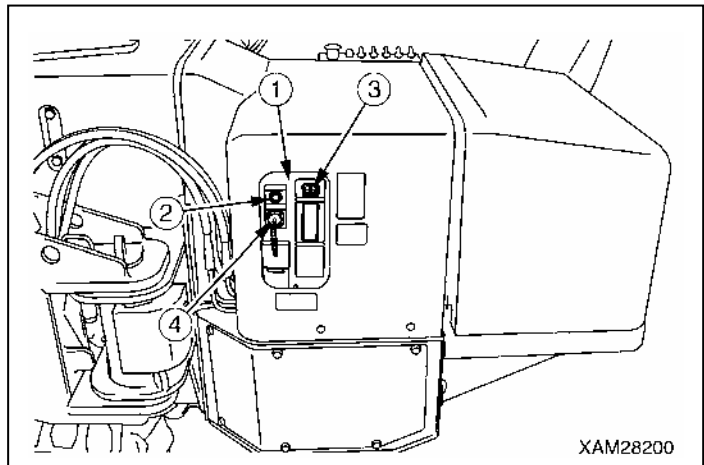

#### NOTES

In the condition that the Transmitter is not powered ON , or reception has an error, the Monitor display shows the error code, "E2", when the Receiver is turned ON.

## 7.2 CHECKING AFTER STARTING ENGINE

### ⚠ WARNING

Precautions shown in this section must be practiced prior to the day's work, without fail. Serious injury or death may arise when these inspections are neglected. Further, refer to the section of "OPERATION 2.1 Checking before Operation" for the checking of the crane structure. Whenever any failures are revealed in such inspections, repair them, or contact us or our agents for services.

### 7.2.1 VERIFICATION FOR THE ENGINE START AND STOP

#### ⚠ WARNING

- Ensure that the boom and outriggers are in the stow position, entirely. In case where they are not in those positions, manipulate applicable levers of the Crane to make them stowed. Otherwise, the Transmitter operation may cause damages to the Crane or tipping that results serious injury or death.
- The Crane is inoperable in such event where the LCD screen in the Transmitter shows an error message or the Monitor display in the Receiver shows an error code. Without fail, examine the cause of the error and perform appropriate service when any fault is identified, or contact us or our agents for services.

#### [1] CHECKING ENGINE START OPERATION

1. Position the Starter Switch of the Crane to ON.
2. Next, push the Power switch of the Transmitter, to power ON.
3. Then turn ON the Main switch of the Receiver.
4. Here, push the Horn button and confirm that the horn toots.
5. Use the Start/Reset button to check that the engine starts properly.
6. Check whether the indication as "START" appears in the LCD screen, at that time.

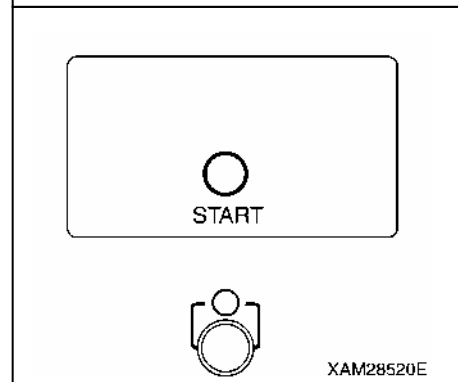
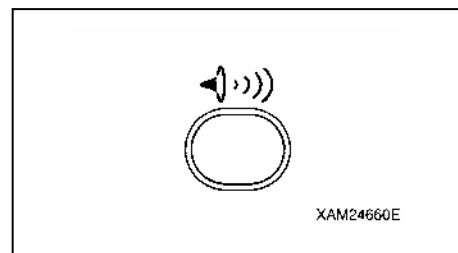

#### [2] CHECKING ENGINE EMERGENCY STOP OPERATION

1. When the engine is started as in the above [1], try the Stop/EMO button to confirm that the engine absolutely stops.
2. Here, check whether the indication as "STOP" appears in the LCD screen. Further, confirm that the Monitor display in the Receiver shows the error code, "E1", at that time.

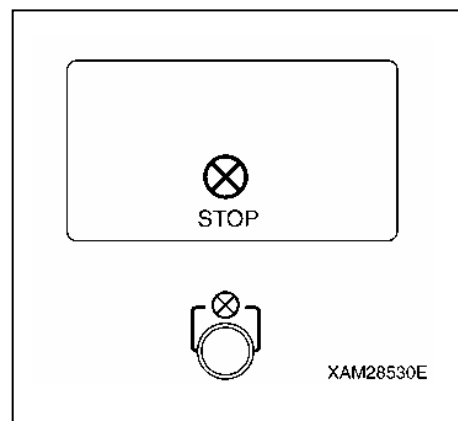

## 7.2.2 CHECKING “OUTRIGGER MODE” OPERATION

### ⚠ WARNING

The Crane is inoperable in such event where the LCD screen in the Transmitter shows an error message or the Monitor display in the Receiver shows an error code.  
Without fail, examine the cause of the error and perform appropriate service when any fault is identified, or contact us or our agents for services.

1. Position the Starter switch of the Crane to ON.
2. Push the Power switch of the Transmitter to power ON.
3. Turn ON the Main switch of the Receiver.
4. Switch the operation mode to the “OUTRIGGER MODE” and confirm that “Ground setting mode” is indicated in the LCD screen.

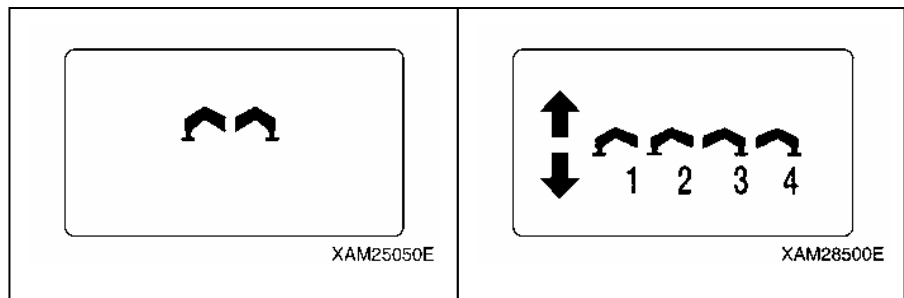

5. Push the Speed/Mode button.

Here, confirm that the “Outrigger Extension mode” is exhibited.

Switching between “Outrigger Extension mode” and “Outrigger Ground setting mode” is alternately by each push of the Speed/Mode button.

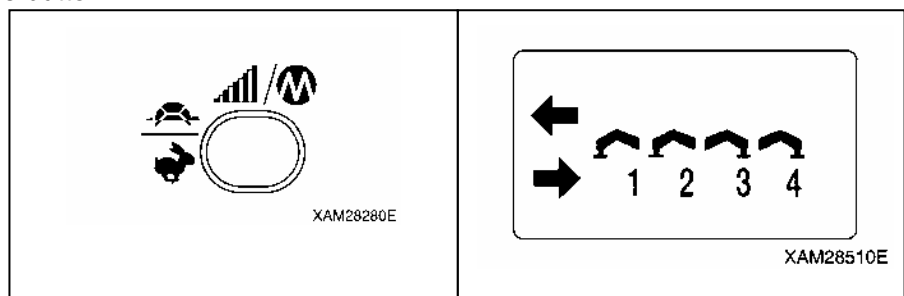

6. Push the Start/Reset button and start the engine.
7. Use the Slewing/No.1 Outrigger operation lever, to the both “Extend (lower)” and “Retract (upper)” area, and check that the No. 1 outrigger follows the lever operation.

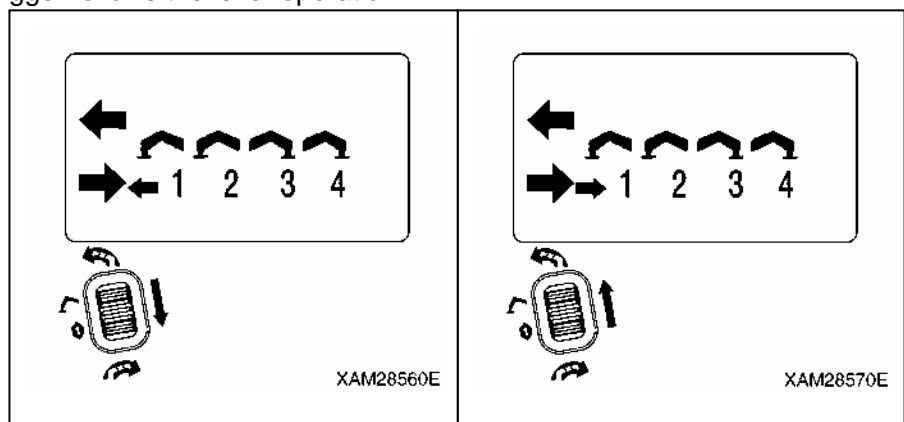

8. During the control lever manipulation, slowly pull and release the Accelerator lever and confirm that the speed of outrigger action follows the acceleration ratio.

9. Try other outriggers, No. 2 to 4 by the same manipulation and confirm that the outriggers correctly respond to the lever control. Lastly, manipulate all the outrigger operation levers to “Extend (lower)”.

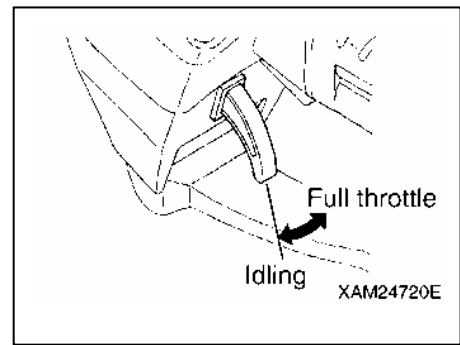

10. Use the Speed/Mode button to switch to the “Ground setting mode”.

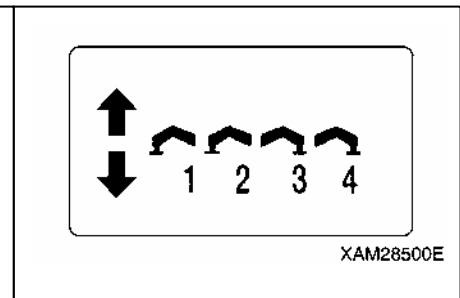
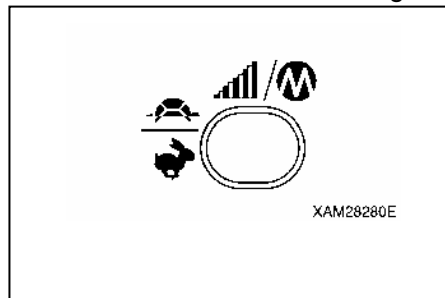

11. Use the Slewing/No.1 Outrigger operation lever, to the both “Extend (lower)” and “Retract (upper)” area, and check that the No. 1 outrigger follows the lever operation.

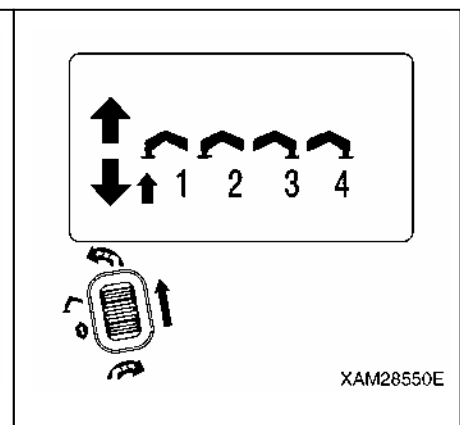
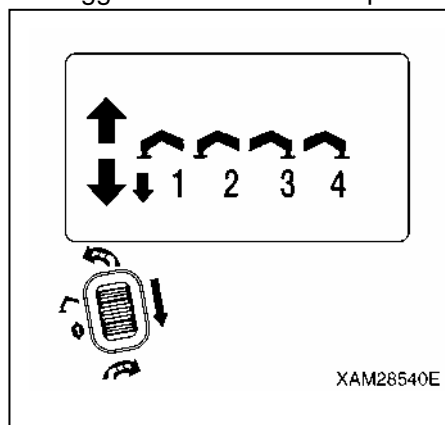

12. During the control lever manipulation, slowly pull and release the Accelerator lever and confirm that the speed of outrigger action follows the acceleration ratio.

13. Try other outriggers, No. 2 to 4 by the same manipulation and confirm that the outriggers correctly respond to the lever control.

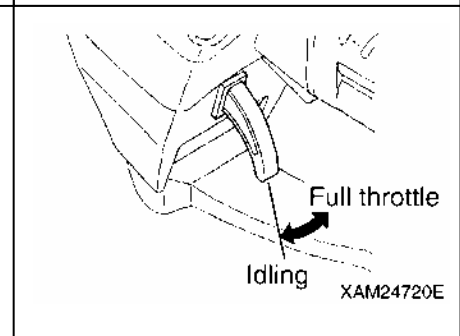

### 7.2.3 CHECKING “CRANE MODE” OPERATION

#### **⚠ WARNING**

- Ensure that all the outriggers are securely settled, before starting crane operations. Any crane operations where outriggers are improperly used cause the tip of the Crane or other serious accidents.
- The Crane is inoperable in such event where the LCD screen in the Transmitter shows an error message or the Monitor display in the Receiver shows an error code. Without fail, examine the cause of the error and perform appropriate service when any fault is identified, or contact us or our agents for services.

1. Start the engine by the Starter switch of the Crane.
2. Refer to the contents of “OPERATION 2.16 Operations before Crane Operations” and “OPERATION 2.17 Crane Operation Posture” and configure the Crane as shown in the figure, right.
3. Push the Power switch of the Transmitter to power ON.
4. Then turn ON the Main switch of the Receiver.
5. Enter into “CRANE MODE”; confirm that the indication as “CRANE MODE” is displayed in the LCD screen.

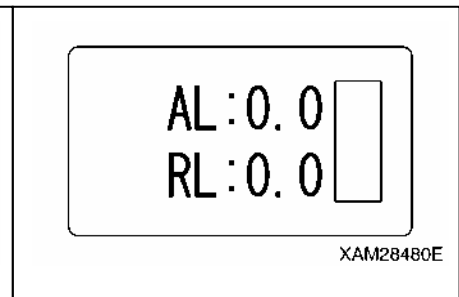
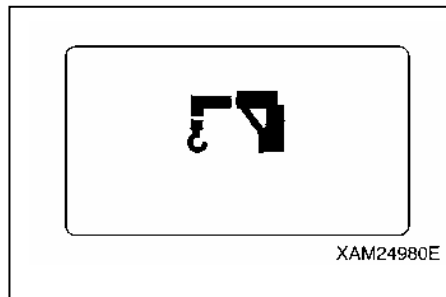
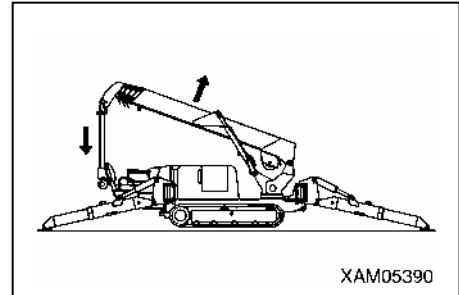

6. Use the Boom derricking lever to the both “Raise (upper)” and “Lower (lower)” area, pull the Accelerator lever and check that the boom follows the lever operation.

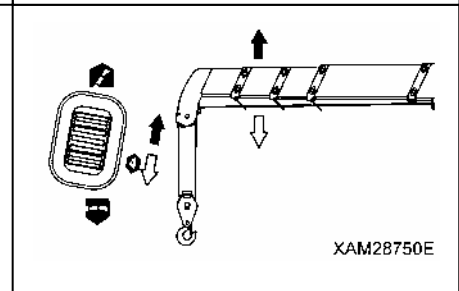

7. Raise the boom to the sufficient angle (approximately 60 degree) by the Boom derricking lever, pushing to the “Raise (upper)” area.

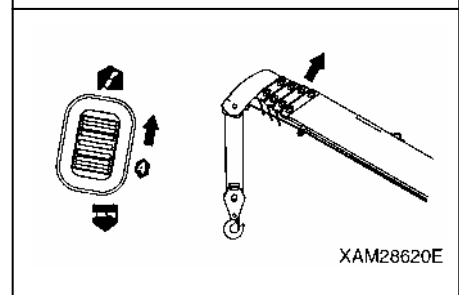

8. During the Hook raising and lowering lever manipulation, to the “Raise (upper)” and “Lower (lower)” area respectively, pull the Accelerator lever and check that the hook follows the lever operation.

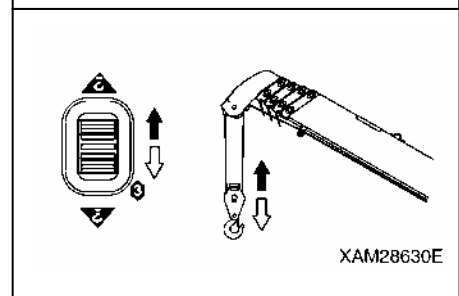

9. Using the Hook raising and lowering lever to the “Lower (lower)” area, lower the hook as much as possible.

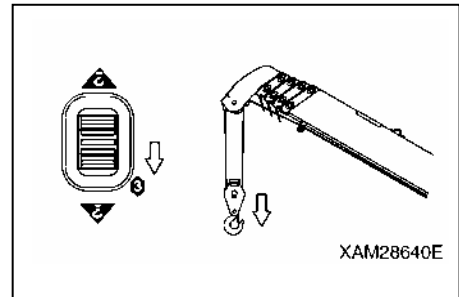

10. During the Boom telescoping lever manipulation, to the “Extend (upper)” and “Retract (lower)” area respectively, pull the Accelerator lever and check that the boom follows the lever operation.

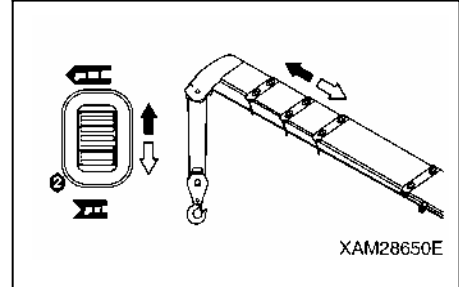

11. Using the Hook raising and lowering lever to the “Raise (upper)” area, hoist the hook.

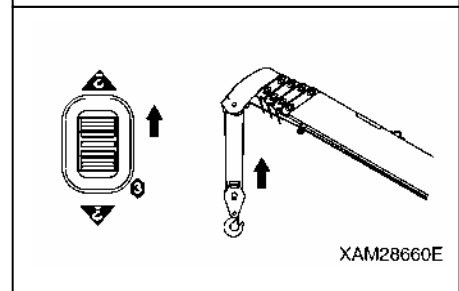

12. During the Slewing lever manipulation, to the “Counterclockwise (upper)” and “Clockwise (lower)” area respectively, pull the Accelerator lever and check that the Crane follows the lever operation.  
In addition, practice a slew around 360 degrees or more to check any abnormal conditions

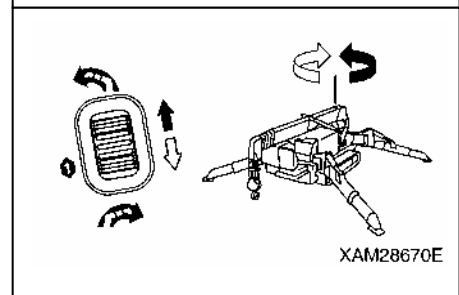

13. During each control lever manipulation of 6. through 12., above, slowly pull and release the Accelerator lever and confirm that the speed of each action follows the acceleration ratio.

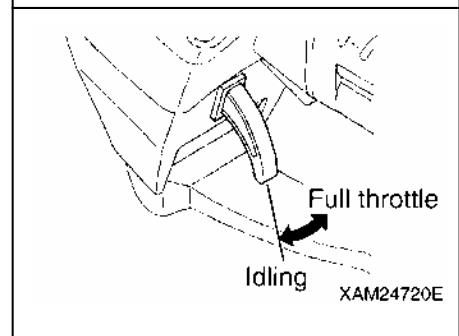

14. During each control lever manipulation of 6. through 12., above, push the Speed/Mode button, then try both “Micro speed command” and “Enhanced speed command” and confirm the speed of each operation corresponds to respective controls of “Micro speed command” and “Enhanced speed command”.

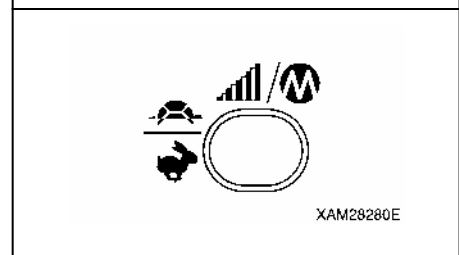



15. Keep pushing the Hook Stow/Setting button and pull the Accelerator lever to verify the hook is stowed properly.

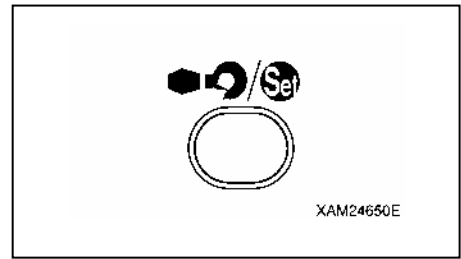

## 8. OPERATION

### **⚠ WARNING**

- In no event, attempt to disassemble or modify the Transmitter or Receiver, which may cause an electrical shock or a fire.
- Avoid to make an impact to the Transmitter by dropping or hitting. A damaged part of the enclosure allows water to enter inside that brings its troubles or failures and cause a serious hazard, such as malfunction or electrical shock.  
In such event of dropping and damage, send the Transmitter to us or our agents for services.
- In no event, water-wash the Transmitter or Receiver; that allows water to enter inside and brings its troubles or failures and cause a serious hazard, such as malfunction or electrical shock.
- Both remote control operation and manual operation at a time are not allowed.  
That may cause the un-expected behavior of the Crane and results a serious hazard. The Crane must be operated by only in either method. (Manual operation is not available, when the remote control is active.)
- Prior to start the remote control operations, always conduct inspections of both the Transmitter and Receiver, in accordance with “INTERACTIVE REMOTE CONTROL 7. Checking before Operation”.

### 8.1 CAUTIONS BEFORE OPERATION

1. So that dropping the Transmitter is prevented, hook one end of the hook belt (16) to the Transmitter and attach another end to the operator's waist belt, or such.
2. Always conduct inspections of both the Transmitter and Receiver, in accordance with “INTERACTIVE REMOTE CONTROL 7. Checking Before Operation”.
3. Make sure that the receptacles (14) in the both ends of the connection cable are secured to both the Transmitter and Receiver, respectively.

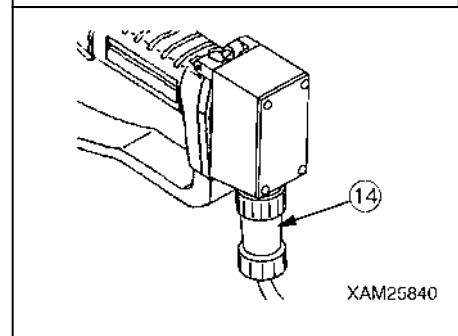
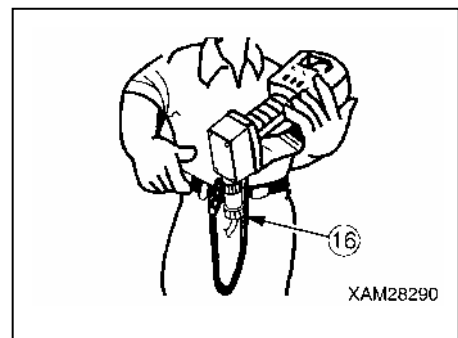

### NOTES

- When it is required to change the initial values of settings such as the contrast of the Transmitter LCD screen, the light, or the OFF timer, once switch to “A MODE” for adjustment.
- In the event that the remote control operation is discontinued for the length of the “Auto shut -OFF time” or more, during the crane operation, the Transmitter power will be automatically cut. To resume the remote control operation, turn ON the Transmitter and set each items for the operation mode, again.

## 8.2 OPERATION IN OUTRIGGER MODE

### ⚠ WARNING

- Check smooth and correct actions of each operation lever of the Transmitter, and they smoothly return to each neutral position when the finger is released.
- Each operation lever of the Transmitter will be blocked by its stopper when it is moved full. When it is blocked, do not attempt to push more, otherwise it may damage the Transmitter to cause its fault and results a serious accident.
- To toggle each operation lever to the opposite side, or to use another lever, always release the Accelerator lever, each time. Also, to operate the outrigger, manipulate the operation lever first, then pull the Accelerator lever. To stop the actuation of outriggers, release your finger from the Accelerator lever, first, then discharge the operation lever.
- For the outrigger operations, always keep the engine speed in the low or middle range. Such operation in the high speed range makes outriggers actuate too quickly, which may tip the Crane and result in a serious hazard.
- For the outrigger operations, always configure the Crane to the stow position. In the condition that the boom is raised or any load is craned, it may cause a serious accident, such as tipping of the Crane.
- For the outrigger operations, always ensure that the position pin of each outrigger is securely inserted. In the event where the pins are missing, the Crane may be tipped and it results in a serious hazard.
- For the installation of outriggers, always extend them first in the “Extension mode”, then switch the mode to “Ground setting mode”. Lift each outrigger equally and gradually, until the Crane is properly elevated. For the stowing of Outriggers, lower each outrigger equally and gradually, until the Crane is grounded in the “Ground setting mode”, then switch to the “Extension mode” to retract them. Unless otherwise this order is followed, that may cause to tip the Crane and bring a serious accident.

1. Ensure that the Main switch of the Receiver is in the OFF position.
2. Start the engine by the Starter switch of the Crane.
3. Push the Power switch of the Transmitter to power ON.  
Confirm that the LCD screen shows the mark as the figure in the right and the “CRANE MODE” is automatically provided.
4. Then turn ON the Main switch of the Receiver.  
The voice message will call you as “Remote control is ready”.

#### NOTES

When the Main switch of the Receiver is turned ON, the abnormal signal detector circuit works for 3 to 4 seconds. During this moment, the Crane is not ready for operations.

#### NOTES

This Crane equips four sets of outriggers and number lables (1) to (4) are appended on each. These labels correspond to the number of each operation lever in the Transmitter. (See the figure in the right.)

MAEDA RADIO  
REMOTE CONTROL

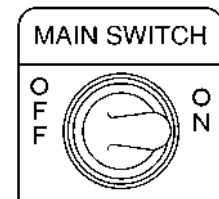

➔ ON XSM04520E

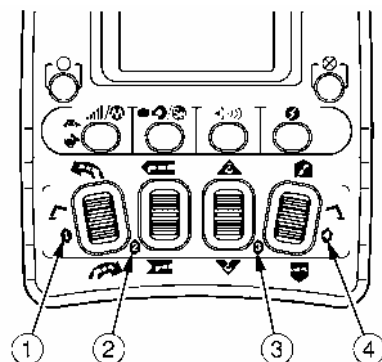

XAM25280E

## 8.2.1 OUTRIGGER SETTING

1. In accordance with "INTERACTIVE REMOTE CONTROL 6.2 Procedure in the Operation Mode", enter into the "OUTRIGGER MODE".

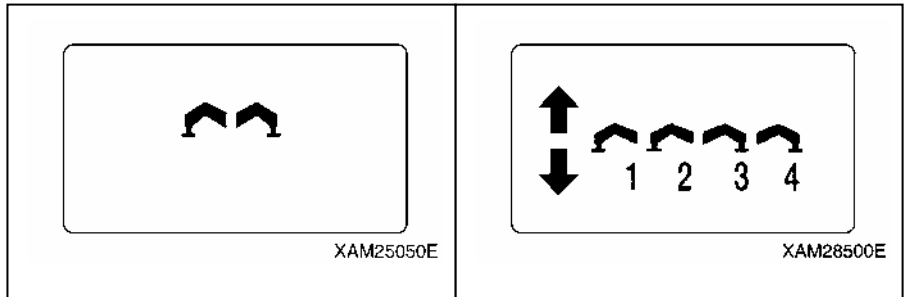

2. Push Speed/Mode button in the mode condition of above 1.  
The operation mode is switched to "Outrigger Extension mode".

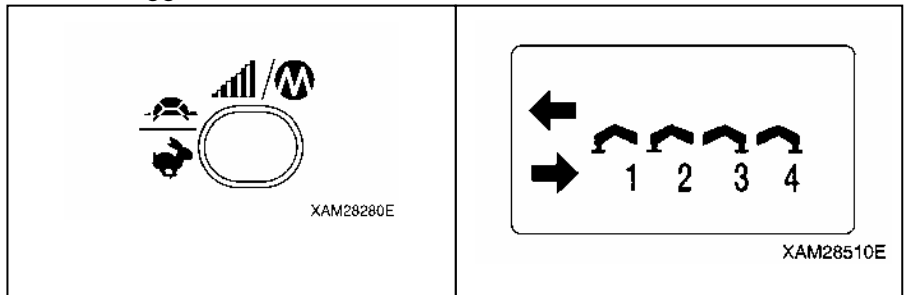

3. Turn one of the outrigger operation levers to "Extend (lower)" and pull the Accelerator lever slowly.
4. When the outrigger is extended to the proper position, slowly release the accelerator lever, then release the outrigger operation lever to return to its neutral position.

|  |
|--|
| <b>NOTES</b>   |
| Repeat the same process to the other three outriggers, so that all of the four outriggers are extended to the proper position. |

5. Push Speed/Mode button in the mode condition of above 4.  
The operation mode is switched to "Ground setting mode".

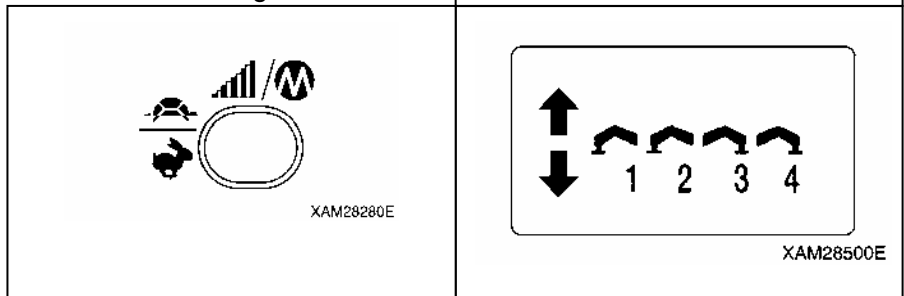

6. Turn one of the outrigger operation levers to "Extend (lower)" and pull the Accelerator lever slowly.

|   |
|---|
| <b>NOTES</b>  |
| Repeat the same process to the other three outriggers and lift all the four outriggers equally and gradually, so that the Crane is properly elevated. |

7. When the Crane is elevated "approximately 50mm", slowly release the Accelerator lever, then release the outrigger operation lever to return to the neutral position.

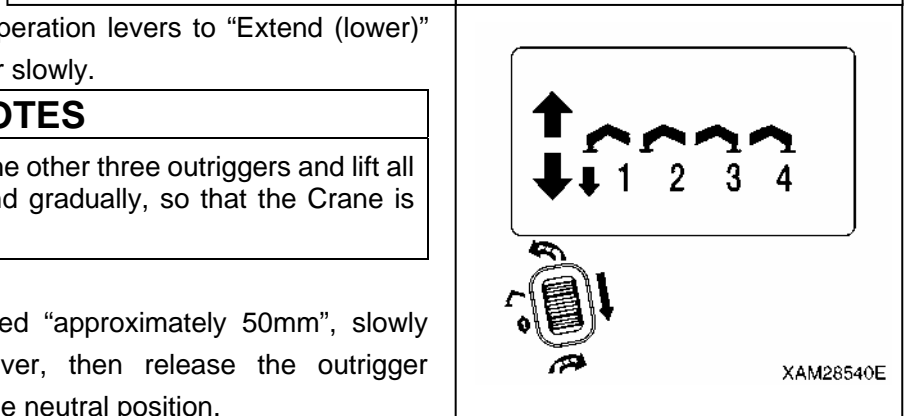

## 8.2.2 OUTRIGGER STOWAGE

1. In accordance with “IINTERACTIVE REMOTE CONTROL 6.2 Procedure in the Operation Mode”, enter into the “OUTRIGGER MODE”.

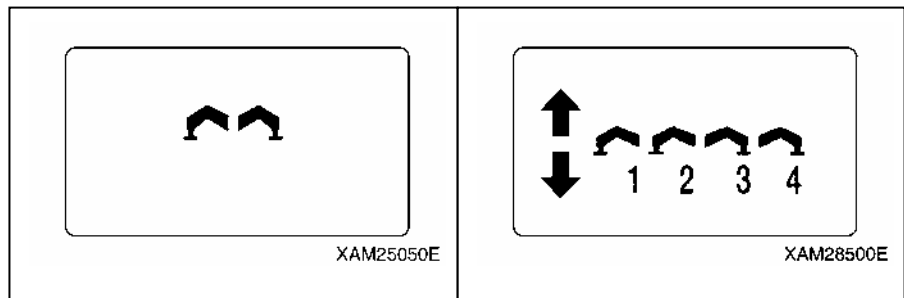

2. Turn one of the outrigger operation levers to “Retract (upper)” and pull the Accelerator lever slowly.
3. When the Crane touches the ground, slowly release the acceleration lever, then release the outrigger operation lever to return to its neutral position.

| <b>NOTES</b>  |
|---|
| <ul style="list-style-type: none"> <li>• Repeat the same process to the other three outriggers and lower all the four outriggers equally and gradually, so that the Crane is grounded.</li> <li>• After the Crane is grounded, lower all the four outriggers completely.</li> </ul> |

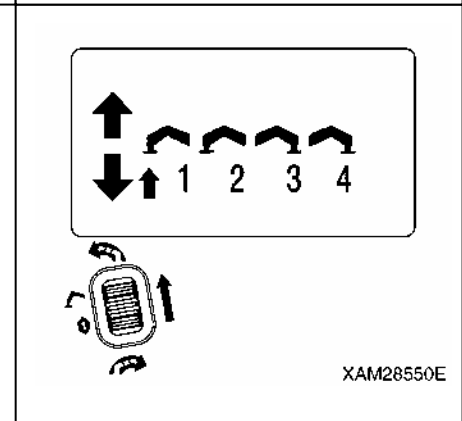

4. Push Speed/Mode button in the mode condition of above 3.  
The operation mode is switched to “Outrigger Extension mode”.

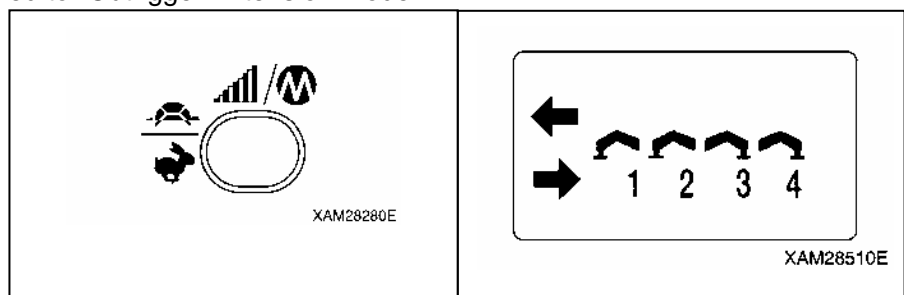

5. Turn one of the outrigger operation levers to “Retract (upper)” and pull the Accelerator lever slowly.
6. When the outrigger is completely retracted, slowly release the Accelerator lever, then release the outrigger operation lever to return to its neutral position.

| <b>NOTES</b>  |
|---|
| Repeat the same process to the other three outriggers to retract all the four outriggers completely and stow them to the proper position. |

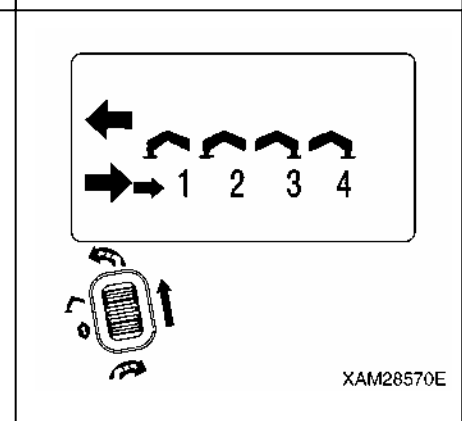

## 8.3 OPERATION IN CRANE MODE

### ⚠ WARNING

- Ensure that all the outriggers are properly installed. Where outriggers are improperly installed, it may result a serious hazard, such as a Crane tipping.
- During crane operations, always refer to the portable rated total load chart and avoid over-loaded operations. Operations in over-loaded conditions may damage or tip the Crane, which results a serious hazard.
- Check the smooth and correct actions of each operation lever of the Transmitter, and that they smoothly return to the each neutral position when the finger is released.
- Each operation lever of the Transmitter will be blocked by its stopper when it is moved full. When it is blocked, do not attempt to push more, otherwise it may damage the Transmitter and cause its fault; it may result a serious accident.
- To toggle each operation lever to the opposite side, or to use another lever, always release the Accelerator lever, each time. Also, to operate the Crane, manipulate the operation lever first, then pull the Acceleration lever, next. To stop the operation of the Crane, release your finger from the Accelerator lever, first, and next discharge the operation lever.
- Always actuate the Accelerator lever with caution to the acceleration rate. It must be properly controlled to keep the appropriate crane operation speed and avoid any abrupt motion. Such abrupt acceleration or deceleration especially while a load is hung will make a large impact to the Crane and may result a serious hazard such as Crane tipping or damage.
- During a load is hung, do not attempt to perform multiple operation at a time, the hook raising and the boom derricking, for instance. That may cause abrupt change of the load condition and cause a serious hazard such as the Crane tipping or damage.

1. Ensure that the main switch of the Receiver is in the OFF position.
2. Start the engine by the Starter switch of the Crane.
3. Push the Power switch of the Transmitter to power ON.  
Confirm that the LCD screen shows the mark as the figure in the right and the "CRANE MODE" is automatically provided.
4. Then turn ON the Main switch of the Receiver.  
The voice message will call you as "Remote control is ready".

#### NOTES

When the main switch of the Receiver is turned ON, the abnormal signal detector circuit works for 3 to 4 seconds. During this moment, the Crane is not ready for operations.

#### NOTES

Four of the Crane operation levers are provided. Each controls the following operation, respectively. (See the figure in the right.)

- (1): Slewing (upper: counterclockwise, lower: clockwise)
- (2): Boom telescoping (upper: extend, lower: retract)
- (3): Hook raising and lowering (upper: raising, lower: lowering)
- (4): Boom derricking (upper: raising, lower: lowering)

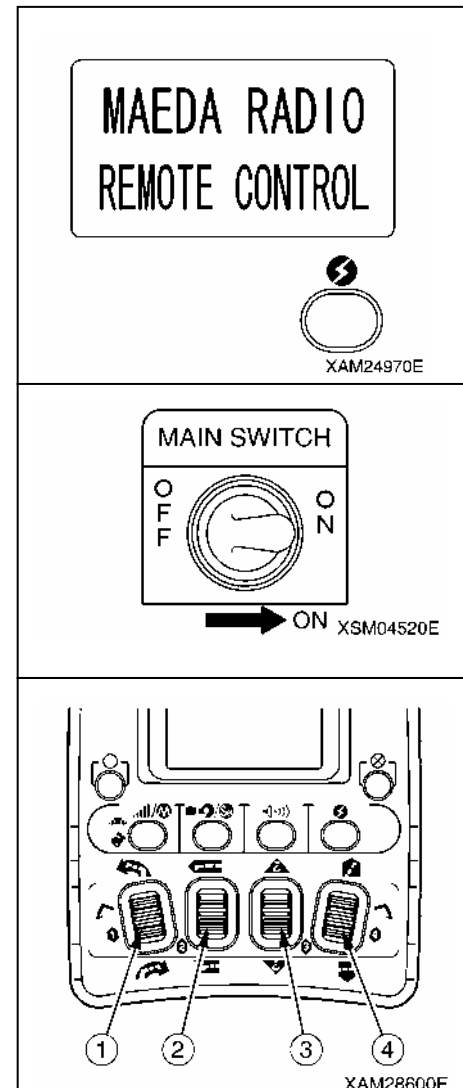

### 8.3.1 SLEWING OPERATION

#### **⚠ WARNING**

At the slewing operation, actuate the Accelerator lever carefully and always keep in low speed. Also, actuate the Accelerator lever slowly and delicately to avoid abrupt slewing. Such abrupt acceleration or deceleration especially while a load is hung will make a large impact to the Crane and may result a serious hazard such as Crane tipping or damage.

#### **[1] SLEW CLOCKWISE**

Push the Slewing/No.1 outrigger operation lever to “Clockwise (lower)”, then pull the Accelerator lever slowly.

The boom slews clockwise, provided that you look down the Crane from the sky.

#### **[2] SLEW COUNTERCLOCKWISE**

Push the Slewing/No.1 outrigger operation lever to “Counter clockwise (upper)”, then pull the Accelerator lever slowly.

The boom slews counterclockwise, provided that you look down the Crane from the sky.

#### **[3] STOP SLEWING**

Release the Accelerator lever slowly, then release the Slewing/No.1 outrigger operation lever to return it to its neutral position.

The boom stops slewing.

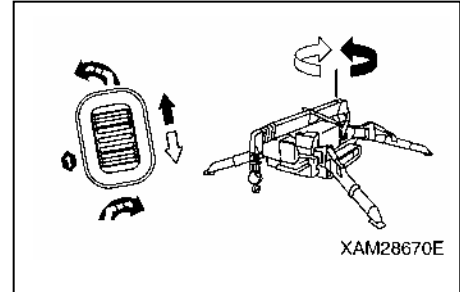

### 8.3.2 BOOM TELESCOPING

#### **[1] BOOM “EXTENDING”**

Push the Boom telescoping/No.2 outrigger operation lever to “Extend (upper)”, then pull the Accelerator lever slowly.

The boom extends.

#### **[2] BOOM “RETRACTING”**

Push the Boom telescoping/No.2 outrigger operation lever to “Retract (lower)”, then pull the Accelerator lever slowly.

The boom retracts.

#### **[3] STOP TELESCOPING**

Release the Accelerator lever slowly, then next release the Boom telescoping/No.2 outrigger operation lever to return it to the neutral position.

The boom stops telescoping.

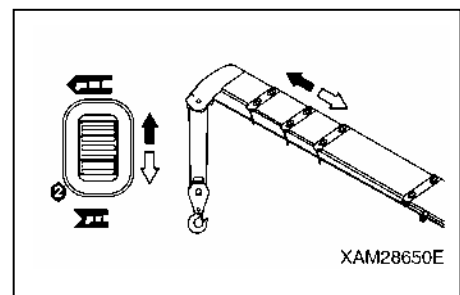

### 8.3.3 HOOK RAISING AND LOWERING

#### **⚠ WARNING**

- In the event of “Over-hoist alarming” or “Automatic cut out” during the hook raising operation, immediately suspend winding. Otherwise, it may cause a damage to the Crane, or the wire-rope is broken which result dropping of the hook or load; a serious accident may happen.
- Continuing the hook lowering in the condition that the load already reached the ground, the random wind of the wire-rope will happen. This may damage the wire rope or shorten its life badly. Further, there is some risk that the wire-rope may bite itself which prevents any more winching. During the hook lowering, always take good care not to cause such random wind.
- The hook is raised or lowered by the boom telescoping or derricking, as well.  
The same attention must be paid as the hook raising and lowering by the winch operation.

#### **[1] HOOK RAISING**

Push the Hook raising and lowering/No.2 outrigger operation lever to “Raise (upper)”, then pull the Accelerator lever slowly.  
The hook starts to be raised.

#### **[2] HOOK LOWERING**

Push the Hook raising and lowering/No.2 outrigger operation lever to “Lower (lower)”, then pull the Accelerator lever slowly.  
The hook starts to be lowered.

#### **[3] STOP RAISING OR LOWERING**

Release the Accelerator lever slowly, then release Hook raising and lowering/No.2 outrigger operation lever to return it to the neutral position.  
The hook stops raising or lowering.

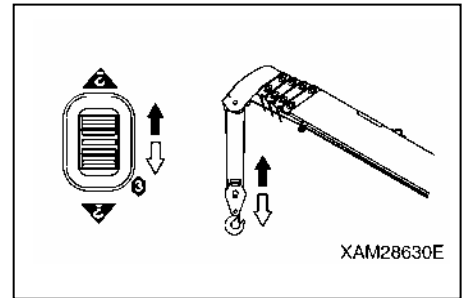

### 8.3.4 BOOM DERRICKING

#### **[1] BOOM RAISING**

Push the Boom derricking/No.4 outrigger operation lever to “Raise (upper)”, then pull the Accelerator lever slowly.  
The boom is raised.

#### **[2] BOOM LOWERING**

Push the Boom derricking/No.4 outrigger operation lever to “Lower (lower)”, then pull the Accelerator lever slowly.  
The boom is lowered.

#### **[3] STOP BOOM DERRICKING**

Release the Accelerator lever slowly, then release the Boom derricking/No.4 outrigger operation lever to return it to the neutral position.  
The boom stops derricking.

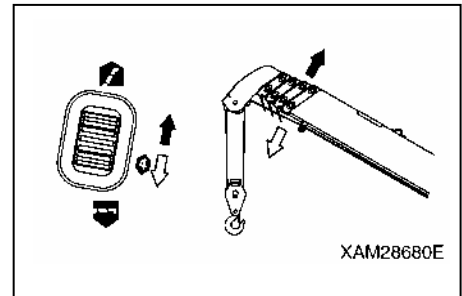



### 8.3.5 AUTOMATIC HOOK STOW FUNCTION

#### CAUTION

This automatic hook stow function is not available in the “Micro Speed mode” or “Enhanced Speed mode”.

To stow the hook, always cancel either the “Micro Speed mode” or “Enhanced Speed mode”. Refer to “INTERACTIVE REMOTE CONTROL 8.3.6 Set-up and Cancel Micro Speed and Enhanced Speed Mode” for details.

1. Configure the boom to the traveling condition and push the Hook raising and lowering/No.2 outrigger operation lever to “Raise (upper)”, then pull the Accelerator lever.  
Keep raising the hook until it touches to the over-hoist detector weight and automatically stops.

#### NOTES

At the time the hook automatically stops, the voice message will call out , ” Danger, rope over winding

2. When the hook automatically stops, push the Hook stow/Setting button.  
LCD screen in the Transmitter displays “HOOK 1”.

#### NOTES

When you push the Hook stow/Setting button, the voice message will instruct you “Do not store hook until boom is in travel mode”.

3. Keep pushing the Hook stow/Setting button, pull the Accelerator lever slowly.  
The hook (4) will be raised to the proper stow position.

#### NOTES

This hook stowage operation is performed under the engine idling condition, regardless of the Accelerator lever rate.

4. When the hook (4) is settled to its position, release the Accelerator lever, then release your finger from the Hook stow/Setting button.

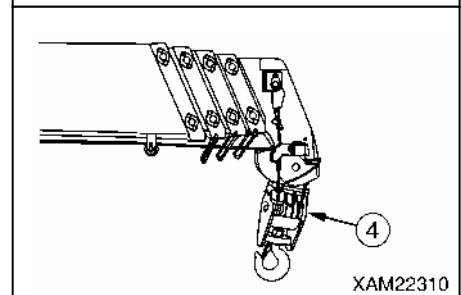
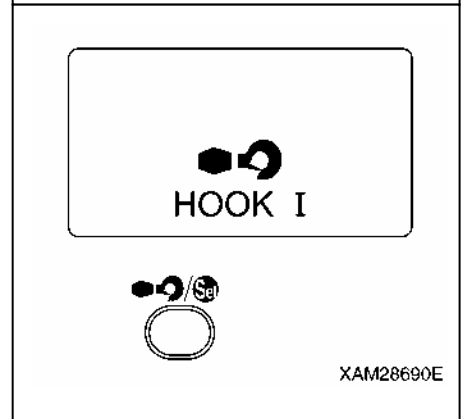
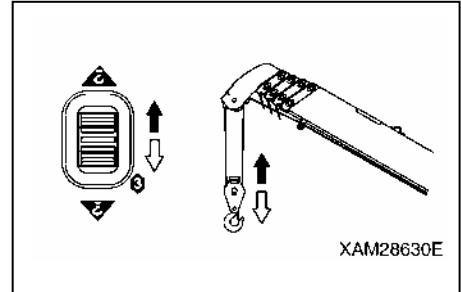

### 8.3.6 SET-UP AND CANCEL MICRO SPEED AND ENHANCED SPEED MODE

When it is required to operate the Crane in low speed, use the Micro speed mode, which limits the maximum speed of the Crane and facilitates the smoother control in the low speed range.

“MICRO SPEED MODE” is available by users’ setting.

Contrary, when it is required to enhance the maximum speed of the Crane operation, the “ENHANCED SPEED MODE” is also available.

#### NOTES

“MICRO SPEED MODE” is valid only in the “CRANE MODE”.

#### [1] SETTING THE MICRO OR ENHANCED SPEED MODE

Push the Speed/Mode button.

Each push will forward the LCD screen indication as shown in the diagram, below:

When the indicated mode fits your requirement, carry on the Crane operation in that condition.

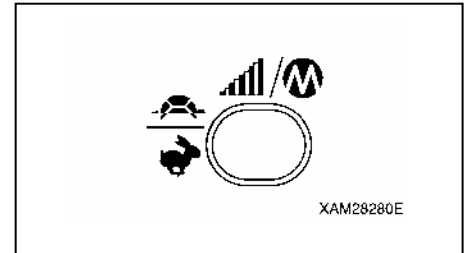

#### [2] CANCEL THE MICRO OR ENHANCED SPEED MODE

Push the Speed/Mode button several times, until LCD screen indication attains the “Normal”.

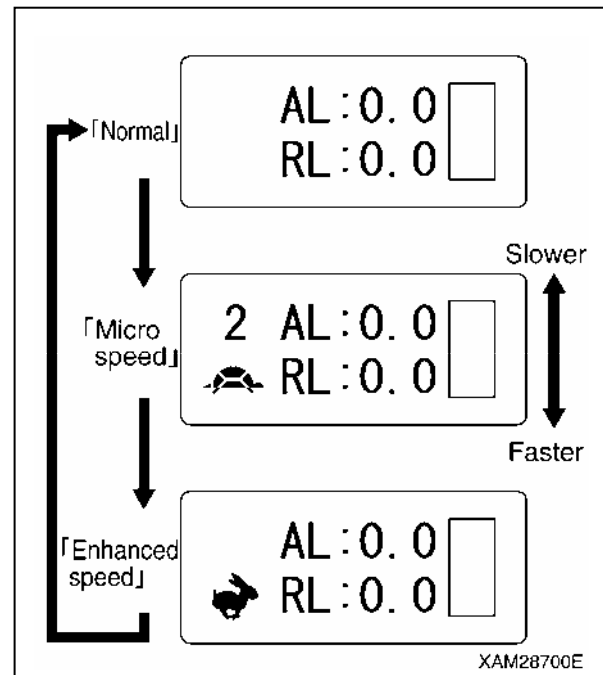

### [3] SETTING TO THE MICRO SPEED MODE

#### **⚠ WARNING**

Setting to the Micro speed mode requires actual crane operations with the engine running. Before starting the Micro speed mode setting, always ensure that nobody except on business is within the working area.

1. Push the Speed/Mode button several times so that the LCD screen indicates the "MICRO SPEED MODE".

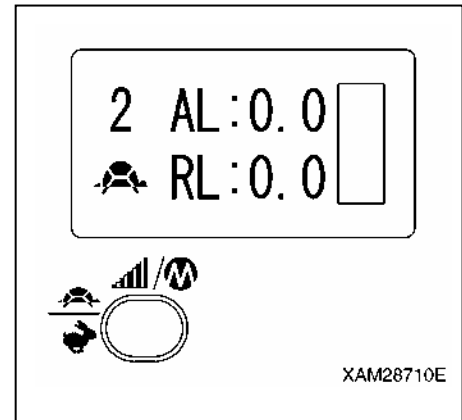

2. Push the Hook stow/Setting button for at least 2 seconds. Indication of "2" in the LCD screen is high-lighted and it enters into the "MICRO SPEED MODE" setting screen.

#### **NOTES**

The "MICRO SPEED MODE" setting is available while the "2" in the LCD screen is high-lighted.

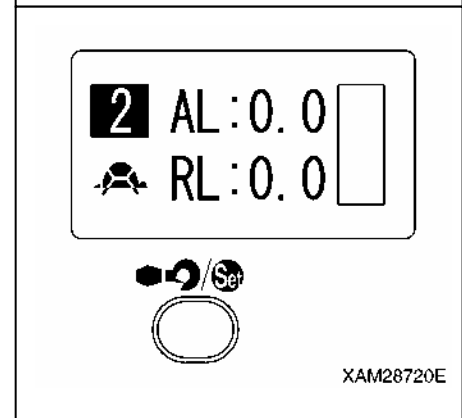

3. Push the operation lever to be adjusted and pull the Accelerator lever slowly.

When the operation speed reaches the desired maximum speed, push the Hook stow/Setting button.

#### **NOTES**

- Perform the same process to other operation levers, respectively.
- In case that you operate two or more levers at the same time for this setting, note that the Micro speed rate is established to the ratio of the fastest operation of all. It is recommended that the Micro speed shall be set one by one of each operation lever
- No operation lever provides the Micro speed unless otherwise set to the Micro speed mode, beforehand

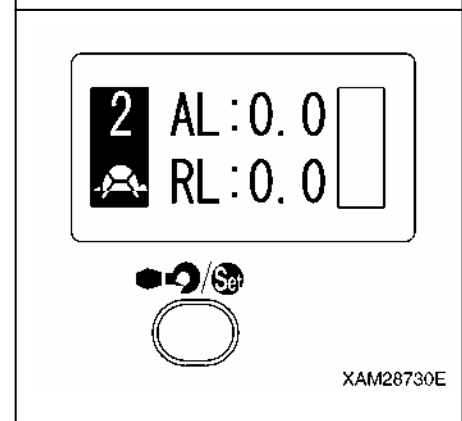

4. When the settings for all the required operation levers are complete push the Speed/Mode button. Now the setting is established and the Micro speed mode is available.

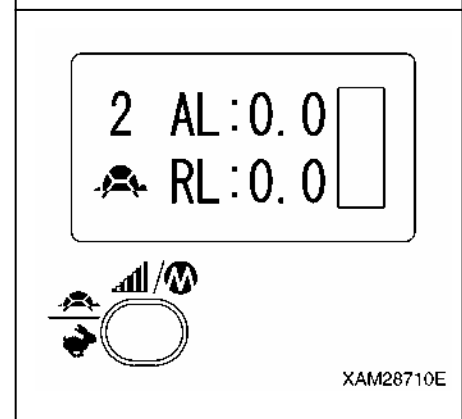

### 8.3.7 ENGINE STOP AND EMERGENCY STOP PROCEDURE

#### ⚠ WARNING

- For any abnormalities in crane operations, push immediately the Stop/EMO button to stop the engine. Such cases include that the crane operation does not stop though you release your fingers from any of the operation levers or Accelerator lever, or the Crane starts the operation despite that no operation lever is manipulated.
- In such event of the emergency stop of the engine, turn OFF the power of the Transmitter and check the cause of the emergency, after the engine stops, and repair the failure.
- The Stop/EMO button is also available to stop the engine in the normal conditions.

Push the Stop/EMO button to stop the engine from the Transmitter or in case of emergency.

The engine stops.

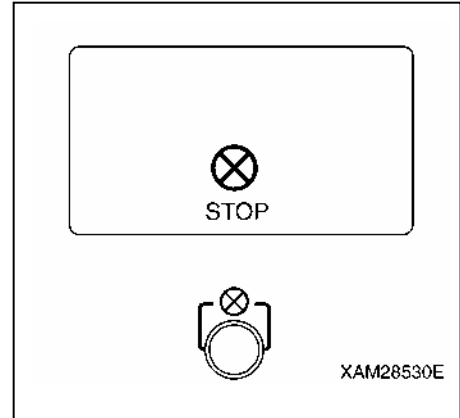

### 8.3.8 ENGINE START AND RESET PROCEDURE

#### [1] ENGINE START PROCEDURE

#### CAUTION

For the practice of the engine start from the Transmitter Start/Reset button, the Starter switch of the Crane must be in the ON position. Otherwise, where the Starter switch is in OFF position, the engine will not start by that Start/Reset button.

When it is required to start the engine from the Transmitter, push the Start/Reset button. The engine starts.

#### [2] RESET PROCEDURE

To release the emergency stop equipment or abnormal signal detector, push the Start/Reset button.

Power of the Receiver will be reset.

#### NOTES

- While the engine runs, the engine starter will not work even though the Start/Reset button is used.
- When the Start/Reset button is used, push the Power switch of the Transmitter to turn ON it, beforehand.
- When the Start/Reset button is pushed, the abnormal signal detector circuit starts working. Wait for 3 to 4 seconds until it completes.

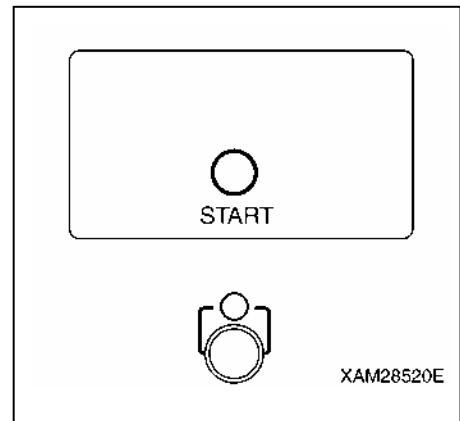

## 8.4 CHECKING AFTER CRANE OPERATION

### WARNING

- When the operation of the Crane is finished, always turn OFF the Transmitter and Receiver power.
- In no occasions except the Crane operations, power of the Transmitter shall not be turned ON. That may cause an un-expected motion of the Crane and result a serious hazard, such that the Crane hit the other person or any object, or the Crane tips.
- When it is required to turn ON the Transmitter for the purpose of inspection or such, ensure first that the engine is standstill, then shut down the Receiver by turning OFF its main switch.

1. Enter into the “CRANE MODE” of the Transmitter operation mode.
2. Use the operation levers and retract the boom to its shortest condition and lower it to the base position, then stow the hook.
3. Enter into the “OUTRIGGER MODE” of the Transmitter operation mode.
4. Use the operation levers and stow all the outriggers so that the Crane is configured to the traveling mode.
5. Stop the engine and turn OFF the Transmitter power.
6. Shut down the power of the Receiver by turning its Main switch to the OFF position.
7. Maintain the Transmitter and Receiver as follows:
  - (1) Check operation levers and the Accelerator lever for any faults.
  - (2) Remove oil or other soil by a clean cloth, if any.
  - (3) Repair all the cracks or damages without fail, if any.
8. Put the transmitter into the accessory storage case and keep it in the dry and cool place where the wind and rain or direct sun ray is sheltered.

## 9. TROUBLE SHOOTING

### 9.1 BEFORE THE TROUBLE SHOOTING

“While Crane operates perfectly under manual control, a part or whole functions are un-operable by the remote control.”

In such event of failure as above, perform the DIAGNOSIS shown in next pages.

#### CAUTION

First, check in accordance with the table below before you start the diagnosis, based on next pages. Such an error may be occasionally fixed by simple practice, such as applying another operation procedure or replacing batteries. Where the checking by the table below and diagnosis in accordance with the process in the next pages fail to fix the errors or faults, contact us or our agents for services. When such errors are due to the electrical failure of the remote control devices, the Crane is operable under the manual control from the Crane.

| Check Points  | Cause and Action   |
|---|--|
| The Crane is operable under the manual control from the Crane.  | When the Crane operates, this remote control device has a failure. Otherwise, when the Crane does not operate, perform the diagnosis of the Crane, itself. |
| Power of the Transmitter and Receiver is ON.  | Turn ON the power, when not.   |
| The fuse in the Receiver is blown.  | Check whether the fuse is blown or not; check the cause when blown, then replace with a new one.   |
| Indications in the LCD screen of the Transmitter are OK.  | Turn ON the power, when not. When the indications are still not available, repair or replace.  |
| The Transmitter enclosure is deformed or damaged.   | Where the Transmitter enclosure is deformed or damaged, repair or replace it.  |
| Each operation lever of the Transmitter is in its neutral position. The Accelerator lever is completely returned. | In any event of operation levers and control buttons failure, repair or replace.   |
| Manipulation began just after the Power switch of the Transmitter is turned ON.                                   | Allow 3 to 4 seconds after the Transmitter power is turned ON, with no operations.   |
| The LCD screen in the Transmitter or the Monitor display in the Receiver shows error messages or error codes.     | In the event where the error messages or error codes are indicated, once power OFF the Transmitter and turn it ON again.                                   |

## 9.2 ERRORS IN THE REMOTE CONTROL DEVICES.

- At the error diagnosis, always verify the indications in the Monitor display in the Receiver and the LCD screen in the Transmitter. Then find the suitable error display description in the table below so that the cause is presumed, then, follow the recommended remedy in it.
- First, perform the “Remedy 1” in the table, then continue the “Remedy 2” where the error is not fixed yet.
- Remedies marked with ★ must inevitably be contacted us or our service agents.
- When any other causes are suspected than listed below, contact us or our service agents.

| Error display |          | Main cause   | Remedy   |                      |
|---------------|----------|--|--|----------------------|
| Transmitter   | Receiver |  | Remedy 1   | Remedy 2             |
| —             | —        | Receiver printed circuit board (PCB) input voltage dropped.<br>• Relay PCB defective.<br>• Power line wire harness defective between relay PCB and Receiver PCB.   | ★Maintenance/replace   |                      |
|               |          | Receiver PCB defective   | ★Maintenance/replace   |                      |
| —             | E0       | Communication error<br>• Relay PCB in the Crane side defective.<br>• Wiring failure between the communication PCB and the Moment limiter display panel.<br>• The Moment limiter display panel defective. | • Power ON again the Transmitter and Receiver<br>• Shut down the electrical power of the Crane, then ON again. | ★Maintenance/replace |
| ⊗<br>STOP     | E1       | The Transmitter is in emergency stop   | • Use the Reset button to release the emergency stop.  | ★Maintenance/replace |
| —             | E2       | The Transmitter defective<br>• The Transmitter power is not ON.<br>• The Transmitter PCB defective.<br>• Wire cut in the Connection cable.   | • Power ON again the Transmitter<br>★Maintenance/replace<br>★Maintenance/replace                               | ★Maintenance/replace |
|               |          | The Receiver defective.<br>• The Receiver PCB defective.<br>• Wiring problem in the Receiver   | ★Maintenance/replace   |                      |
|               | E3       | The Transmitter defective<br>• The Transmitter PCB defective.<br>• Voltage dropped in the Transmitter.<br>• Wirings for Accelerator and operation levers cut, or fault of VR.                            | • Return the Accelerator lever and power ON the Transmitter, again   | ★Maintenance/replace |
| —             | E4       | The Transmitter defective<br>• The Transmitter Accelerator lever position defective.   | • Return the Accelerator lever and power ON the Transmitter, again.  | ★Maintenance/replace |
| —             | E5       | The Transmitter defective<br>• The Accelerator lever was pulled, when power was turned ON.   | • Return the Accelerator lever and push the Reset button.  | ★Maintenance/replace |
| —             | E6       | The Receiver PCB defective<br>• Data error in the memory.  | • Power on the Receiver, again.  | ★Maintenance/replace |
| —             | E7       | The Receiver PCB defective<br>• CPU error  | • Power on the Receiver, again.  | ★Maintenance/replace |

| Error display   |          | Main cause  | Remedy   |                      |
|---|----------|---|--|----------------------|
| Transmitter   | Receiver |   | Transmitter  | Receiver             |
| —   | —        | <ul style="list-style-type: none"> <li>The Transmitter, internal Devices defective.</li> <li>Data error in the memory.</li> </ul>   | <ul style="list-style-type: none"> <li>Power on the Transmitter, again.</li> </ul>   | ★Maintenance/replace |
| —   | 8 9      | <ul style="list-style-type: none"> <li>The Transmitter, internal devices defective.</li> <li>Operation levers were not in the neutral position, when power was turned ON.</li> </ul>  | <ul style="list-style-type: none"> <li>Return operation levers and push the Reset button.</li> </ul>                               | ★Maintenance/replace |
| The Crane operates perfectly under the manual mode but some functions are not available in the remote control mode. |          | <ul style="list-style-type: none"> <li>The Receiver PCB defective.</li> <li>Wiring failure between the Receiver PCB and the control valve solenoids.</li> <li>Electromagnetic proportional control reducing valve error.</li> </ul> | <ul style="list-style-type: none"> <li>★Maintenance/replace</li> <li>★Maintenance/replace</li> <li>★Maintenance/replace</li> </ul> |                      |



## 10. SYSTEM SPECIFICATIONS

| Items                          |                          | MCT310   |                              |
|--------------------------------|--------------------------|--|------------------------------|
| Waterproof protection          |                          | IP65   |                              |
| System configuration           |                          | Manual and Remote control, both-way  |                              |
| Operation monitor              |                          | LCD monitor panel<br>• Operation status monitor • Battery monitor • Message • Error code |                              |
| Safety devices                 |                          | Emergency stop equipment   |                              |
|                                |                          | Abnormal signal detector unit at the engine start  |                              |
|                                |                          | Automatic power cut unit (Automatic Power-OFF)   |                              |
|                                |                          | Voltage drop limiter   |                              |
|                                |                          | Warning switch   |                              |
| Voice messages                 |                          | (1) Danger, rope over winding  |                              |
|                                |                          | (2) Do not store hook until boom is in travel mode                                       |                              |
|                                |                          | (3) Remote control is ready  |                              |
|                                |                          | (4) Signal not received  |                              |
|                                |                          | (5) Danger, defective safety device  |                              |
|                                |                          | (6) Danger, defective remote control   |                              |
|                                |                          | (7) Danger, set outriggers   |                              |
|                                |                          | (8) Danger, overload   |                              |
| Control unit voltage           |                          | Power for the Crane (DC 12V)   |                              |
| Control unit power consumption |                          | Approximately 70 watts (maximum, per single function)                                    |                              |
| Operating ambient temperature  |                          | -10°C to +55°C   |                              |
| Storage ambient temperature    |                          | -20°C to +70°C   |                              |
| Transmitter weight             |                          | 540g   |                              |
| Transmitter functions          | Lever switches           | Boom raise/lower   | Raising and lowering         |
|                                |                          | Hook raise/lower   | Raising and lowering         |
|                                |                          | Boom telescoping   | Extending and retracting     |
|                                |                          | Slewing  | Counterclockwise/clockwise   |
|                                | Push button switches     | Power  | ON/OFF                       |
|                                |                          | Horn   | Warning signal               |
|                                |                          | Hook stow/Setting  | Hook stowing/Mode setting    |
|                                |                          | Speed/Mode   | Speed control/Mode selection |
|                                |                          | Start/Reset  | Engine start/Reset           |
|                                |                          | Stop/EMO   | Engine stop/Emergency stop   |
|                                | Trigger type accelerator | Hydraulic control + Engine control   |                              |

# ENGINE AND ELECTRIC MOTOR SPECIFICATIONS

|  |      |
|--|------|
| 1. PRECAUTIONS (FOR ENGINE AND ELECTRIC MOTOR SPECIFICATION) | 7- 2 |
| 2. SAFETY LABEL LOCATIONS                                    | 7- 3 |
| 3. MACHINE EACH SECTION                                      | 7- 5 |
| 4. OPERATION   | 7-14 |
| 5. LONG-TERM STORAGE   | 7-21 |
| 6. ELECTRIC MOTOR TROUBLESHOOTING                            | 7-22 |
| 7. PRINCIPLE SPECIFICATION LIST                              | 7-23 |
| 8. SPECIFICATION DIMENSINAL DRAWING                          | 7-24 |

# 1. PRECAUTIONS (FOR ENGINE AND ELECTRIC MOTOR SPECIFICATION)

## ⚠ WARNING

The following precautions should always be observed when using the machine abiding by engine and electric motor specifications. Potential serious accident may occur if disregarded.

- Installation of this machine must comply with laws and regulations of your country.  
Contact us or our sales service agency if no laws and regulations are applied.
- Only personnel qualified according to laws and regulations of your country are allowed to establish power connection of power supply equipment, inspect and repair the electric system. Contact us or our sales service agency if no laws and regulations are applied.
- Operation and storage of this machine must satisfy the requirements listed below:
- Operating temperature: -10 to 40°C (no frost)
- Storage temperature: -20 to 60°C
- Operating humidity: Max. 90%RH (no condensation)
- Atmosphere: Outdoor environment free from explosive, flammable, and corrosive gases, moisture, and excessive dust particles
- Altitude: Max. 1000m
- Vibration: Max. 0.5G
- Turn OFF the power supply equipment breaker promptly in the event of an abnormal event in this machine during operation. Potential fire or electric shock may occur if disregarded.
- Turn OFF the power supply equipment breaker promptly in the event of a power failure during operation. This machine may go into action upon energization.
- Always turn OFF the power supply equipment breaker before performing inspection and maintenance of the electric system. Potential electric shock may occur during work if disregarded. Before inspection and maintenance, inform all personnel to alert them of your action. Be sure to attach a warning tag, "Do Not Touch", to the power supply equipment breaker for the prevention of accidental breaker operation conducted by other personnel.
- Always turn OFF the power supply equipment breaker and wait for 10 minutes or longer before performing inspection and maintenance of the electric system.  
Ensure that no voltage is applied to the power supply box with a tester.
- All the parts will be at elevated temperatures immediately after machine operation.  
Perform inspection and maintenance of the electric system according to the procedure provided in this manual only after the parts drop in temperature for safety. Potential burn may occur if disregarded.
- Keep the power supply box and inverter board away from water.  
The machine goes out of order that causes malfunction if the electric system is wetted. Exercise due caution to handle the electric system.
- Contact us or our sales service agency to request repair of the inside of the inverter board, when necessary.

## CAUTION

See "Safety" for safety precautions that are not provided in this section.

The weight (mass) of a machine varies with machine types between a standard specification machine and a machine abiding by engine and electric motor specifications.

See the following figure for the weight (mass) of the machine described in "Safety 2.3 WORKING WITH CRANE" and loads imposed on one wire rope for machine hoisting with four wire ropes.

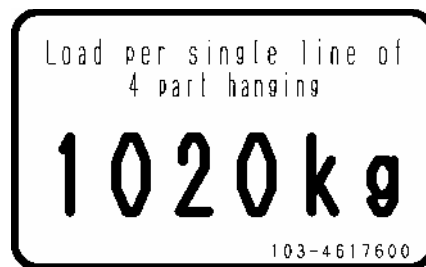
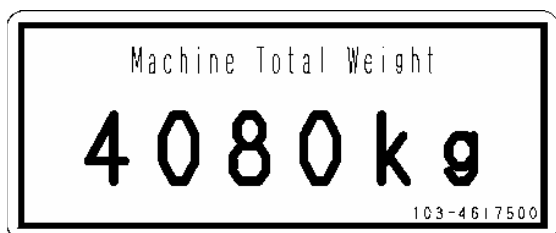

## 2. SAFETY LABEL LOCATIONS

Keep these labels clean all the time.

If lost, apply again or replace with new one.

Labels other than the following safety labels exist, treat same.

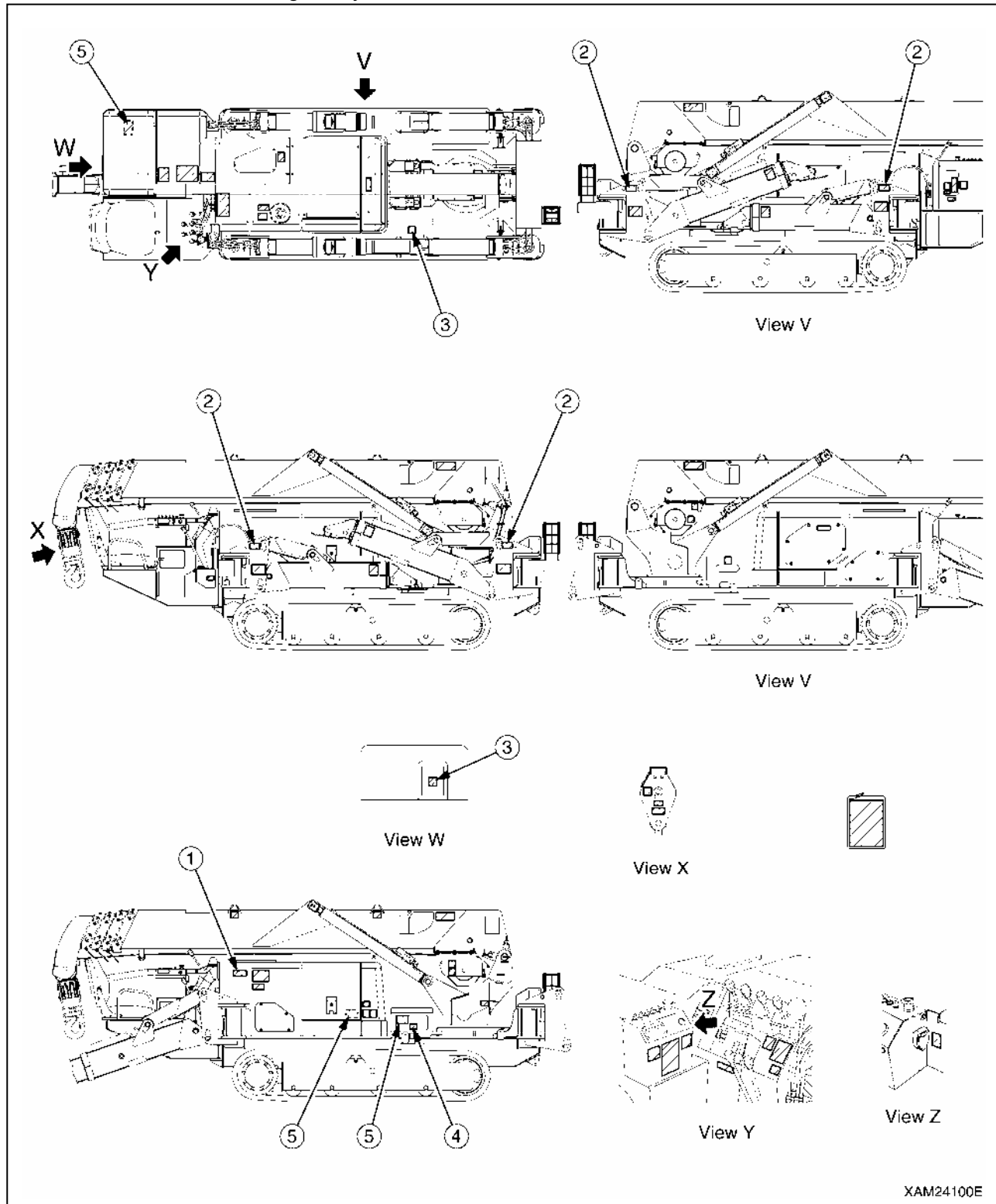

## CAUTION

The different and supplementary labels are applied to the machine abiding by engine and electric motor specifications, as compared with the standard specification machine. This section describes the labels designed for the machine abiding by engine and electric motor specifications.

See "Safety 6. Safety Label Locations" for the safety labels that are not described in this section.

(1) Total machine weight (103-4617500)

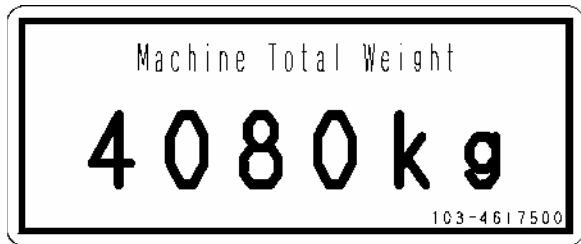

(2) Loads on 4-rope machine hoisting (103-4617600)  
(4 pieces)

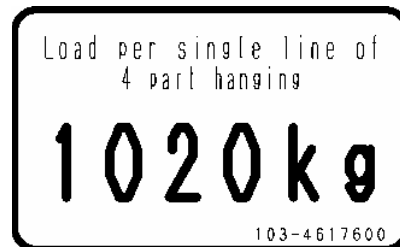

(3) Electric shock caution (553-4267300) (2 pieces)



(4) Washing caution (350-4539700)

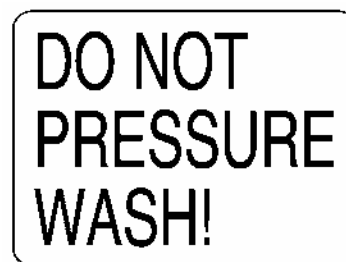

(5) WEEE directive (104-4549500) (3 pieces)



[LOCATIONS OF WEEE DIRECTIVE LABELS]

- Front of the inverter board
- Side of the electric motor
- Side of the accelerator (in engine room)

### 3. MACHINE EACH SECTION

#### 3.1 MACHINE EACH UNIT

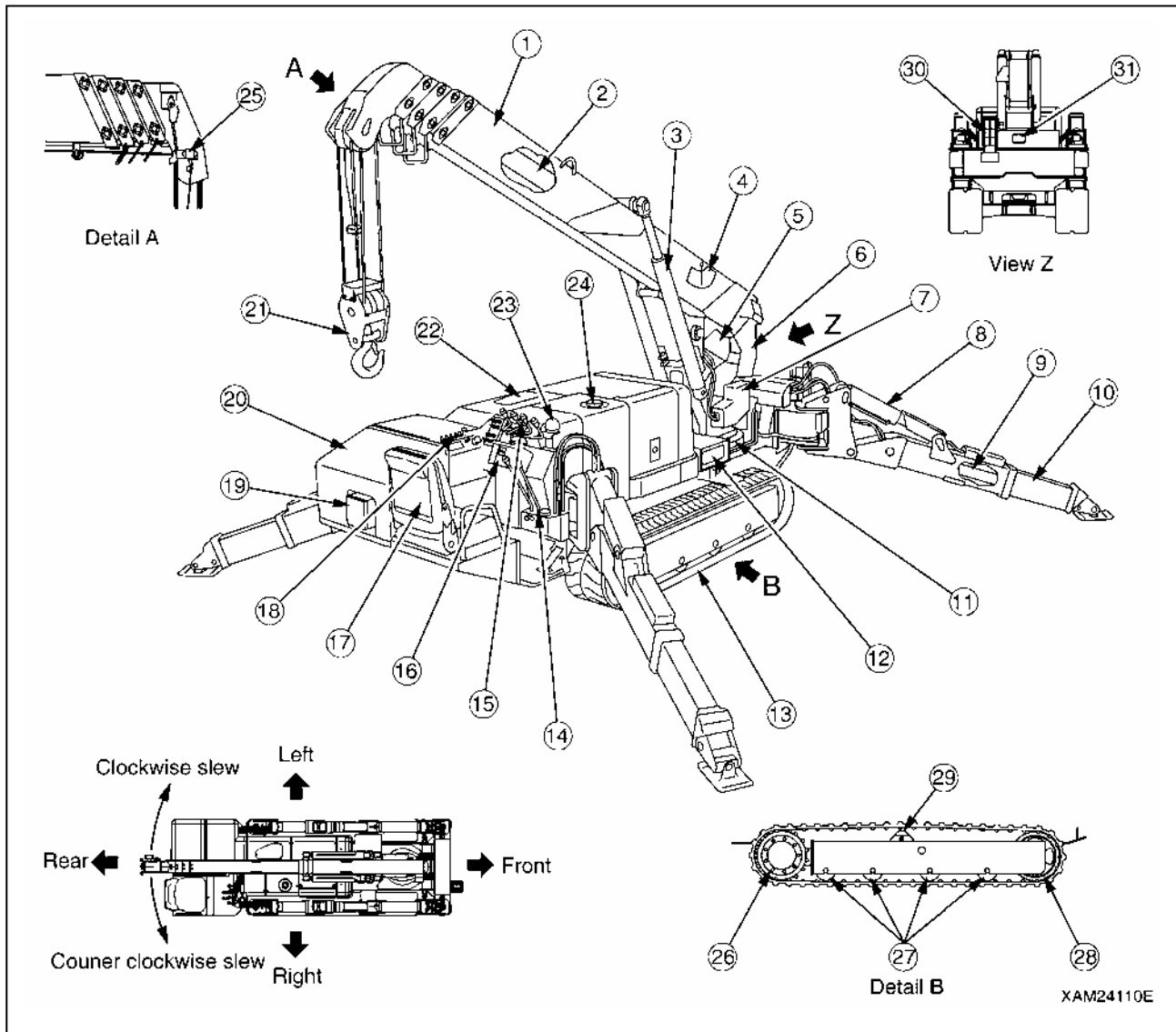

- |   |  |
|---|--|
| (1) Boom  | (17) Operation seat                              |
| (2) Boom telescoping cylinder (Inside the boom)     | (18) Instrument panel                            |
| (3) Boom derricking cylinder                        | (19) Power supply box                            |
| (4) Load indicator                                  | (20) Power unit cover                            |
| (5) Winch   | (21) Hook block                                  |
| (6) Post  | (22) Hydraulic oil tank (Inside machinery cover) |
| (7) Moment limiter transducer                       | (23) Outrigger un-set warning lamp               |
| (8) Outrigger setting cylinder                      | (24) Fuel tank (Inside machinery cover)          |
| (9) Outrigger extension cylinder (Built in the box) | (25) Over hoist detector                         |
| (10) Outrigger                                      | (26) Traveling motor and sprocket                |
| (11) Slewing device                                 | (27) Track roller                                |
| (12) Inverter unit                                  | (28) Idler                                       |
| (13) Rubber track                                   | (29) Carrier roller                              |
| (14) Traveling operation unit                       | (30) Working status lamp                         |
| (15) Crane operation unit                           | (31) Headlight                                   |
| (16) Moment limiter display unit                    |  |

### 3.2 TRAVELING AND CRANE OPERATION UNITS

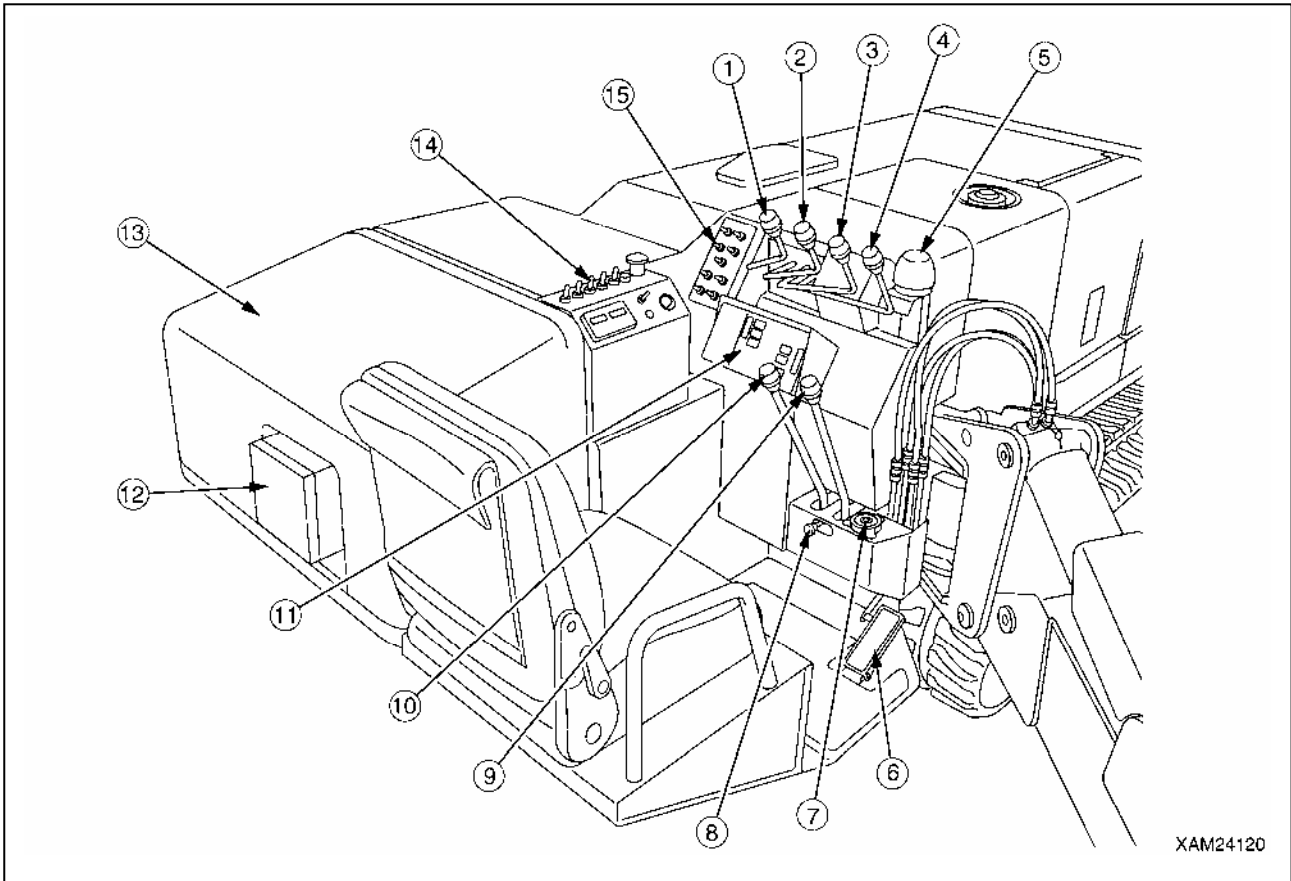

- (1) Slewing lever
- (2) Boom telescoping lever
- (3) Winch lever
- (4) Boom derricking lever
- (5) Outrigger un-set warning lamp
- (6) Acceleration pedal
- (7) Level
- (8) Traveling lock lever
- (9) Right traveling lever
- (10) Left traveling lever
- (11) Moment limiter display panel
- (12) Power supply box
- (13) Power unit cover
- (14) Instrument panel
- (15) Outrigger operation panel

#### **CAUTION**

See "Operation 1.2 Traveling and Crane Operation Units" for details.

### 3.3 INSTRUMENT PANEL SECTIONS

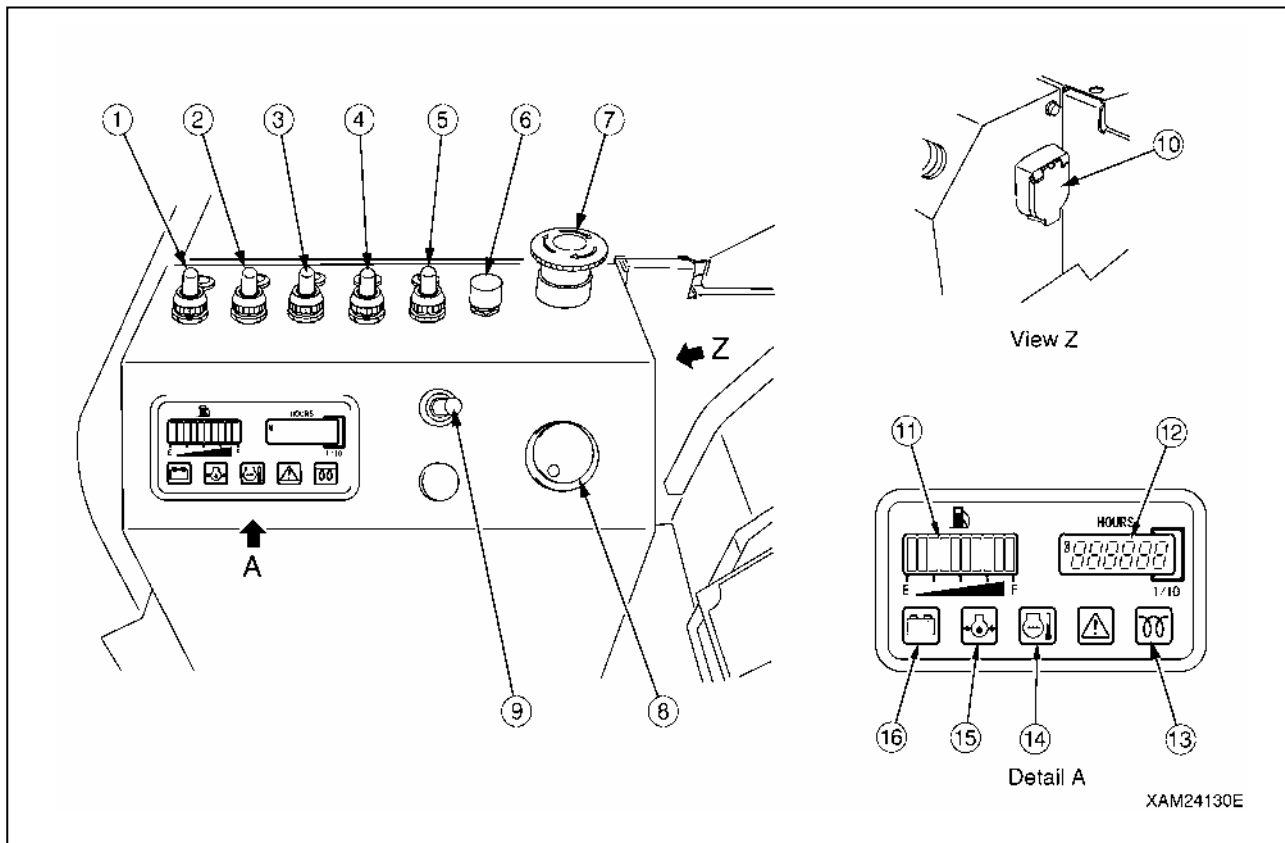

- |                                 |                                       |
|---------------------------------|---------------------------------------|
| (1) Headlight switch            | (9) Engine and electric motor switch  |
| (2) Crane high-speed switch     | (10) Emergency stop cancel switch     |
| (3) Hook stowing switch         | (11) Fuel gauge                       |
| (4) Traveling high-speed switch | (12) Hour meter                       |
| (5) Boom stowing switch         | (13) Pre-heat monitor                 |
| (6) Horn switch                 | (14) Engine water temperature monitor |
| (7) Emergency stop switch       | (15) Engine oil pressure monitor      |
| (8) Starter switch              | (16) Battery charge monitor           |

### CAUTION

This section describes only the switches and monitors that become available when the machine is powered by electric motor.

- This section describes the 4 switches and monitors listed below.

Starter switch (8), engine and electric motor switch (9), emergency stop switch (7), hour meter (12).

See “Operation 1.3 Instrument Panel Sections” for other switches and monitors (8 pieces).

- Following monitors (five) are not active when the electrical motor is the output source.

Fuel gauge (11) pre-heat monitor (13) engine water temperature monitor (14) engine oil pressure monitor (15), battery charge monitor (16).



## [1] STARTER SWITCH

### CAUTION

Always turn the starter switch to the "OFF" position after completing the work.

### NOTES

When inserting the key for the starter switch, slide the cover to the left so that you can see the keyhole of the switch, and then insert the key.

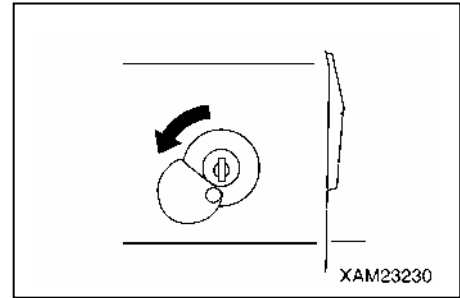

Use this switch to start and stop the electric motor.

- HEAT : Not used
- OFF : You can insert/remove the key at this position. All the switches in the electrical system are turned off and the electric motor stops.
- ON : Electricity runs into the Inverter unit..
- START: When the electric motor has started, release your hand from the key. The key automatically returns to the "ON" position.

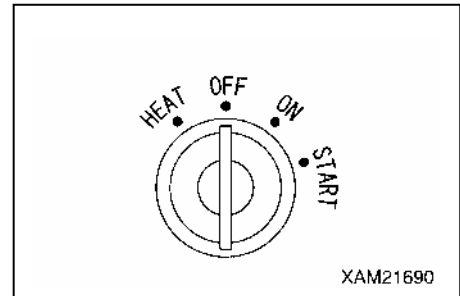

## [2] ENGINE AND ELECTRIC MOTOR SWITCH

### CAUTION

Ensure that the Inverter unit power lamp is ON when switching the engine and electric motor switch to "Electric Motor". Electric operation is permitted only when the power lamp is ON.

Use this switch to switch the power output source of the machine.

- Engine : Push down the switch to the left.  
The engine is designated as a power output source.
- Electric motor : Push down the switch to the right.  
The electric motor is designated as a power output source.

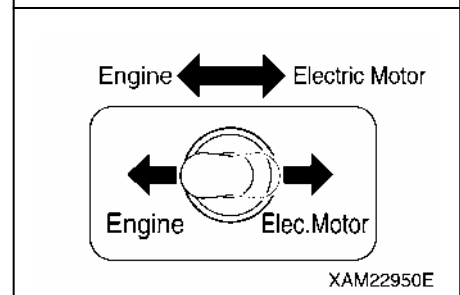
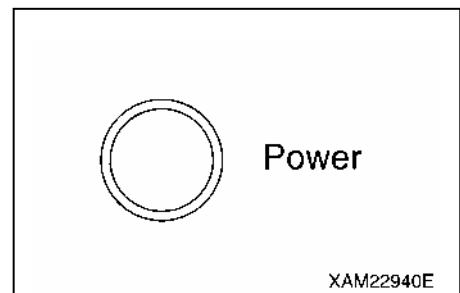

## [3] EMERGENCY STOP SWITCH

Use this switch in case of an error in the machine to stop the machine for emergency.

- ON: Press the switch. The electric motor stops.
- OFF: Turn the switch clockwise (direction of the arrow in the right figure). The switch returns to the original position.

### NOTES

When restarting the electric motor after emergency stop, be sure to turn the emergency stop switch to the "OFF" position before starting the electric motor.

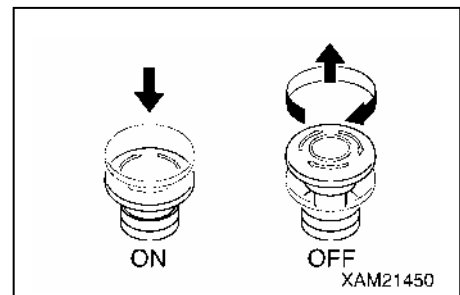

#### [4] HOUR METER

This meter shows the total running hours of the machine.

Use this value as the reference for periodical check interval.

With the power lamp of the Inverter unit ON, the meter gives continuous readings upon switching the engine and electric motor switch to "Electric Motor" and turning the starter switch to the ON position, even if the electric motor and machine are at a halt.

The meter indication advances for "1" when the machine has been running for 1 hour regardless of the engine rotation speed.

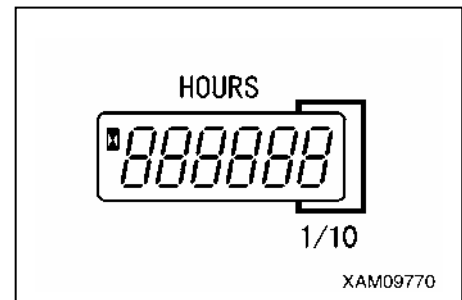

### 3.4 POWER UNIT

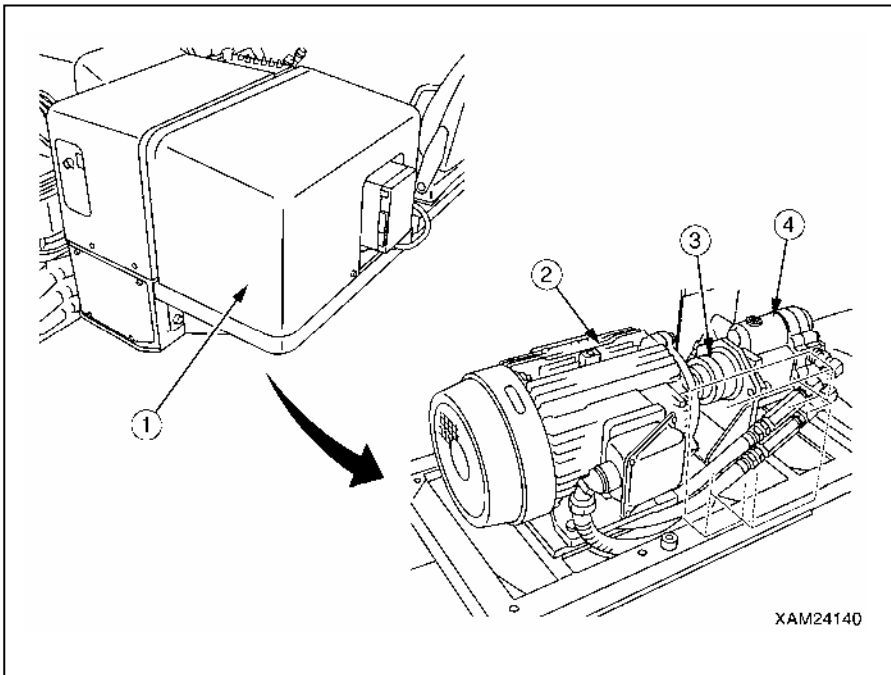

- (1) Power unit cover
- (2) Electric motor
- (3) Coupling
- (4) Hydraulic pump

### 3.5 POWER SUPPLY BOX

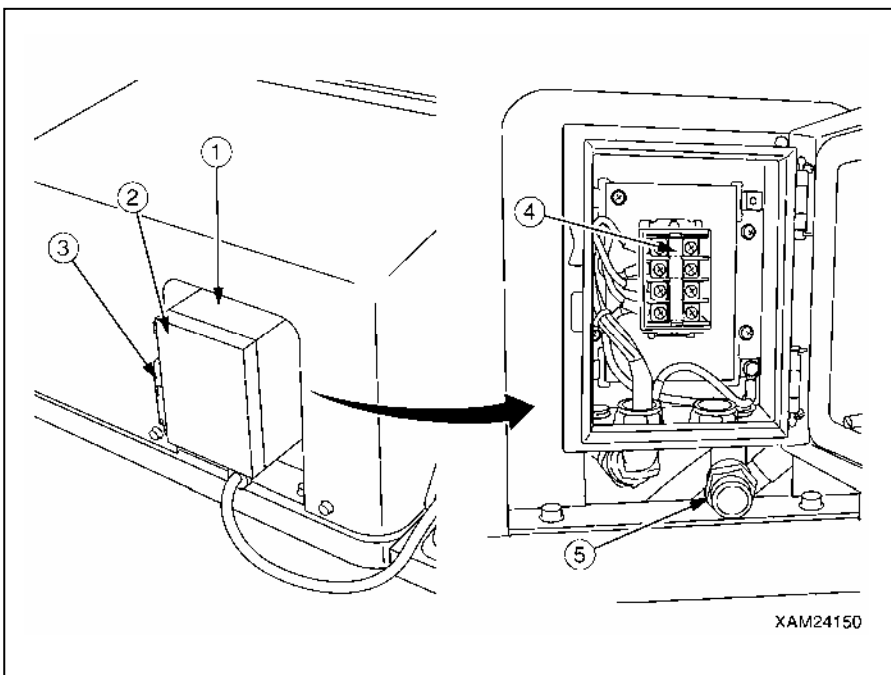

- (1) Power supply box
- (2) Power supply box door
- (3) Door handle
- (4) Terminal block
- (5) Cable inserting hole

### 3.6 INVERTER UNIT

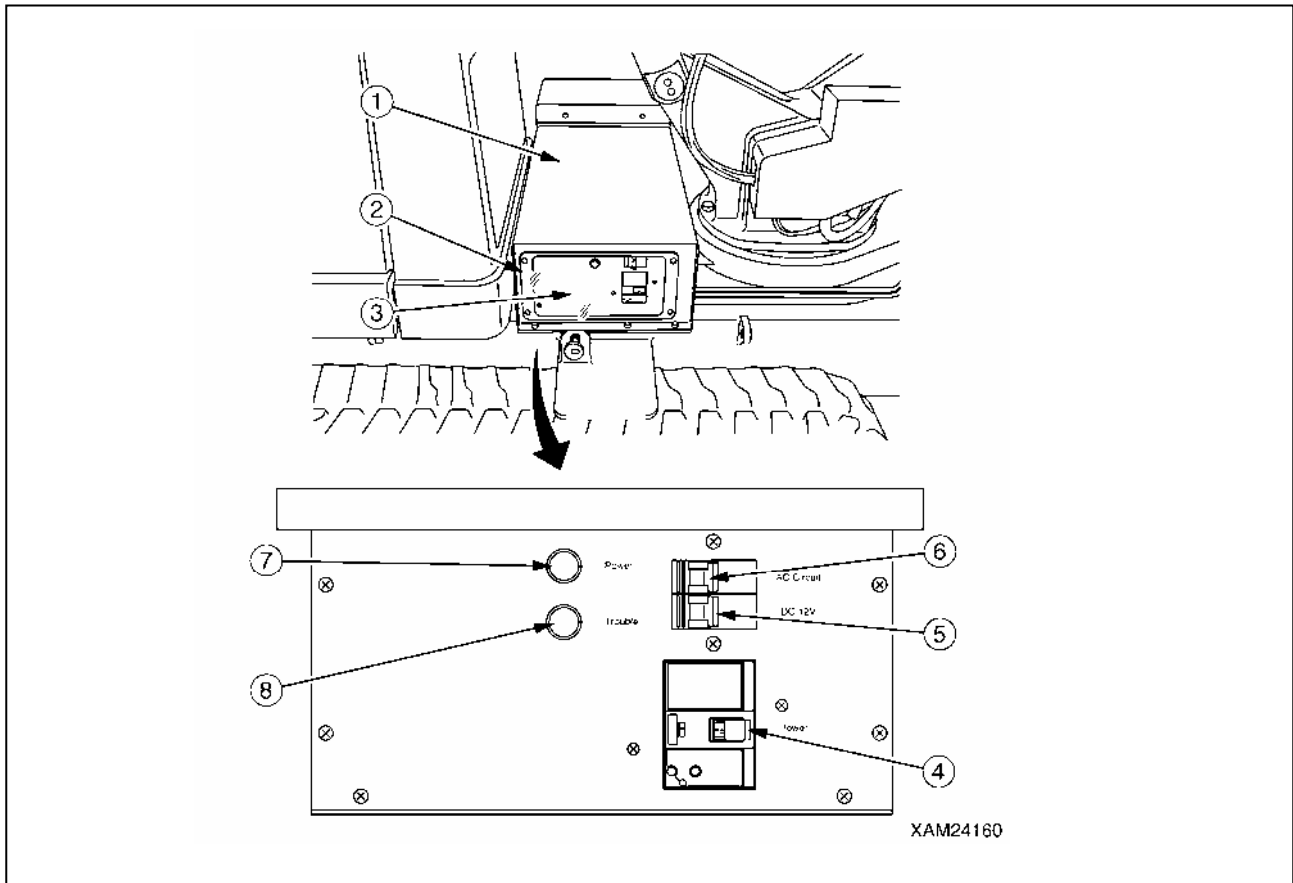

(1) Inverter unit cover

(2) Protective cover

(3) Inverter unit

(4) Main breaker (with a leak detector)

(5) DC12V power switch

(6) AC circuit power switch

(7) Power lamp (white)

(8) Trouble lamp (red)

## [1] MAIN BREAKER (WITH A LEAK DETECTOR)

### ⚠ WARNING

- Make sure the breaker is OFF when this machine derives no power from power supply equipment and when work is completed.
- Abnormal conditions are encountered around the Inverter unit, electric motor, or electric wiring when the breaker is automatically turned OFF during operation. Be sure to locate failures and check for burnt smell and parts. Promptly contact us or our sales service agency to request inspection and repair.
- Inspection and repair must be completed before turning ON the breaker to re-supply power. Potential fire or machine failure may occur if disregarded.

The main breaker is equipped with the parts shown at the right.

- The breaker (1) is designed to provide automatic shutoff of the power that is supplied from the Inverter unit to the electric motor in the event of an error including overcurrent and overvoltage, to prevent fire and machine failure.

The breaker (1) also controls the supply of power to the electric motor and Inverter unit.

- ON : Power is supplied.
- OFF: No power is supplied.
- The overvoltage/ground-fault indication button (2) on the cover is designed to eject in the event of an overvoltage or ground fault. For reset, press the breaker to turn the ON.
- The trip button (3) is designed to mechanically trip the breaker as external control.
- The ground-fault test button (4) is used to test tripping in response to a ground fault.

Proper tripping is assured if the overvoltage/ground-fault indication button (2) on the cover ejects.

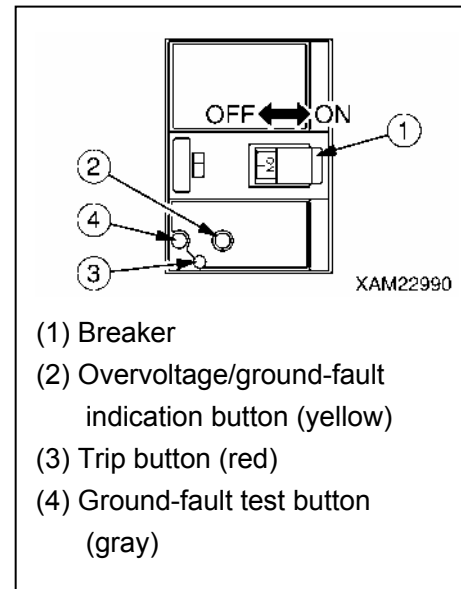

### CAUTION

**Periodic (biannual) ground fault test is recommended. The test button should be controlled at 10-second or longer intervals and not be pressed more than requires. If an indication of a ground fault remains on after the overvoltage/ground-fault indication button (2) is reset, contact us or our sales service agency to request inspection and repair.**

## [2] DC12V POWER SWITCH

The DC12V power switch is used to switch the DC power output source for the crane operation system.

- ON: Power is supplied to the crane operation system.
- OFF: No power is supplied to the crane operation system.

## [3] AC CIRCUIT POWER SWITCH

The AC circuit power switch is used to switch the AC power output source for the Inverter unit and inverter cooling fan.

- ON: Power is supplied to the Inverter unit and inverter cooling fan.
- OFF: No power is supplied to the Inverter unit and inverter cooling fan.

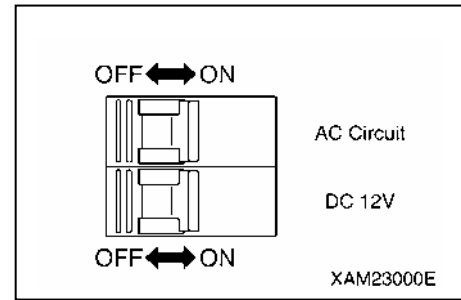

### NOTES

- No safety hazard is posed even if the DC12V power switch and AC circuit power switch remain on.
- The AC circuit power switch is illustrated in the upper figure at the right, and the DC12V power switch is illustrated in the lower figure.

## [4] POWER LAMP (WHITE)

The power lamp is designed to indicate the presence of energization to this machine from power supply equipment.

- ON: This machine is deriving power from power supply equipment.
- OFF: This machine is deriving no power from power supply equipment.

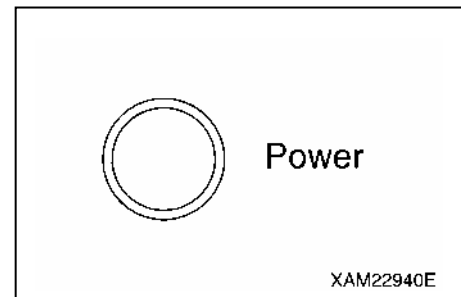

### NOTES

If the power lamp remains off despite the power supply equipment breaker being turned ON with power supply assured between power supply equipment and this machine, check the power supply on power supply equipment.

## [5] TROUBLE LAMP (RED)

### ⚠ WARNING

**An error occurs in the Inverter unit, which causes the trouble lamp to come ON.  
Contact us or our sales service agency to request inspection and repair in the above event.**

The trouble lamp is designed to indicate the presence of an error in the Inverter unit.

- ON: An error is detected in the Inverter unit.
- OFF: The Inverter unit is in normal operation.

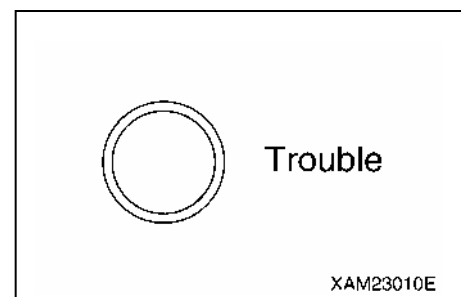

## 4. OPERATION

### 4.1 CHECKING BEFORE OPERATION

#### 4.1.1 CHECKING BEFORE STARTING ELECTRIC MOTOR (VISIBLE CHECKS)

##### **WARNING**

For details in checking before starting engine (visible checks), see “Operation 2.1.1 Checking Before Starting Engine (visible checks)”.

As to the machine abiding by engine and electric motor specifications, potential fire in the machine may occur if a heap of flammable materials and oil leak are present around the hot sections such as the Inverter unit, power supply box, and power unit.

Carefully check around these areas. Should you find any abnormality, be sure to fix it or contact us or our sales service agency.

#### 4.1.2 CHECKING BEFORE STARTING ELECTRIC MOTOR

##### **CAUTION**

For details in checking before starting electric motor, see “Operation 2.1.2 Checking Before Starting Engine”.

#### 4.1.3 CHECKING AFTER STARTING ELECTRIC MOTOR

##### **CAUTION**

For details in checking after starting electric motor, see “Operation 2.1.3 Checking After Starting Engine”.

## 4.2 POWER SUPPLY CONNECTION

### (BETWEEN POWER SUPPLY EQUIPMENT AND MACHINE)

#### **⚠ WARNING**

The following precautions should always be observed. Potential serious accident may occur if disregarded.

- Installation of this machine must comply with laws and regulations of your country. Contact us or our sales service agency if no laws and regulations are applied.
- Only personnel qualified according to laws and regulations of your country are allowed to establish power connection between power supply equipment and this machine. Contact us or our sales service agency if no laws and regulations are applied.
- Be sure to supply the machine specifications-compliant power (AC 380, 400V) to this machine.

| Power supply voltage (V) | Power current (A) | Power supply frequency (Hz) |
|--------------------------|-------------------|-----------------------------|
| 380, 400                 | 11.5              | 50                          |

- A cabtyre cable must adhere to the specifications of this machine (AC 380, 400V).

| Motor voltage (V) | Cable spec. (sq) | Cable length (m) |
|-------------------|------------------|------------------|
| 380, 400          | 3.5              | 20               |
|                   | 5.5              | 40               |

- Always use a dry cabtyre cable. Potential electric shock may occur if the cabtyre cable terminal is wet or power connection is performed with moisted hands.
- Always turn OFF the main breakers of power supply equipment and this machine before connecting the cabtyre cable to this machine.
- Keep the cabtyre cable free of flaws and bend. Be sure to replace a damaged cabtyre cable with a new one.
- Ensure that no sharp protrusion is present at an area where the cabtyre cable is routed. Failure to follow the above precaution may cause the cable to get snagged on the protrusion and damaged or broken.
- To connect the cabtyre cable to the terminal block in the power supply box, torque the screw to the specified value. Potential fire or electric shock may occur if the screw comes loose that could develop a short circuit.
- To connect the cabtyre cable to the terminal block in the power supply box, tighten the cable ground screw properly for the prevention of water entry and cable protection.
- The ground wire of the cabtyre cable must be properly connected to the “PE terminal” at the bottom of the terminal block in the power supply box.
- Always close the power supply box door completely after work, and attach the Inverter unit cover properly.

Use the following procedure for establishing power connection between power supply equipment and this machine.

1. Make sure the breakers of power supply equipment and Inverter unit are OFF.
2. Unlock the door (3) of the power supply box (2) by pulling the handle (4) toward you to open it.

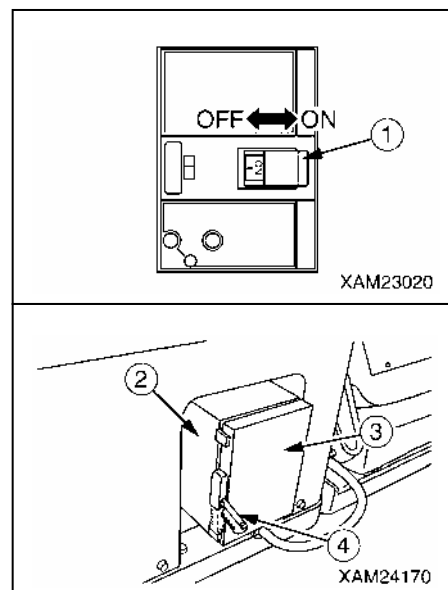



3. Remove the cover (6) of the terminal block (5) in the power supply box, holding the top and bottom of the cover (6) with fingers and pulling it toward you.

4. Draw the machine specifications-compliant cabtyre cable (A) through a hole of the cable ground (7) at the bottom of the power supply box to connect it to the terminal block (5).

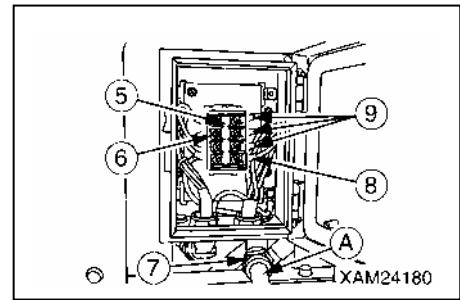

### CAUTION

- The length of a cabtyre cable varies with cable specifications. Any cable length should conform to values listed below.

| Motor voltage (V) | Cable spec. (sq) | Cable length (m) |
|-------------------|------------------|------------------|
| 380, 400          | 3.5              | 20               |
|                   | 5.5              | 40               |

- The ground cable (8) of the cabtyre cable must be properly connected to the “PE terminal” on the terminal block . Inverter-driven three cables (9) other than the ground cable are capable of being connected to any of "L1, L2, and L3 terminals”.

5. Upon completion of connection of the power supply box cabtyre cable (A), replace the cover (6) of the terminal block (7) and close the door (3) of the power supply box (2).

6. Move and connect the cable terminal block to the power supply equipment breaker without undue strain on the cabtyre cable (A).

7. Turn ON the power supply equipment breaker.

8. Remove the four mounting screws (11) and remove the protective cover (10).

9. Turn ON the breaker (1).

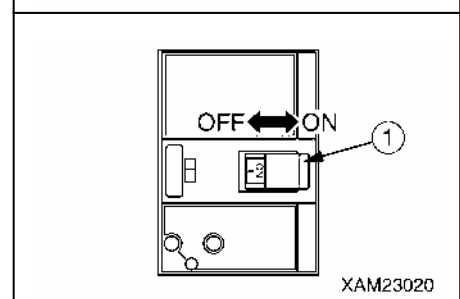
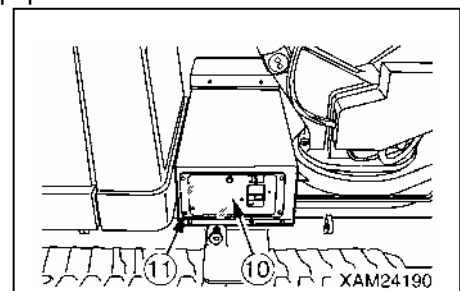

10. Turn ON the AC circuit power switch (12) and DC12V power switch (13).

| NOTES   |
|---|
| No safety hazard is posed even if the AC circuit power switch (12) and DC12V power switch (13) remain ON. |

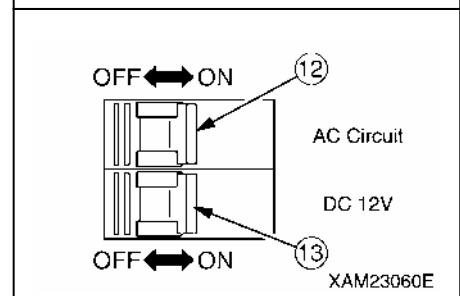

11. Replace the protective cover (10) to the original position and securely tighten four mounting screws (11).

## 4.3 OPERATION AND CHECKING AFTER POWER CONNECTION

### ⚠ WARNING

- Before starting the electric motor, make sure of no presence of personnel around and impediments, and sound a horn.
- Warm-up is required. The motor needs adequate warm-up especially in cold climates. Failure to warm the motor may result in serious accident on account of low reactivity of the traveling gear and crane to the operating lever.
- Ensure that no abnormal noise, odor, or vibration is present in and around the Inverter unit and power unit during warm-up. If abnormal conditions are encountered, immediately turn the starter switch to the OFF position to bring the machine to a halt. Turn OFF the power supply equipment breaker accordingly to shut off the supply source. Check the Inverter unit and electric motor, the peripheries, and electric wiring for burnt smell and parts. Promptly contact us or our sales service agency to request inspection and repair.
- Crane operational check is necessary after motor warm-up. Keep the hook block away from the boom to avoid interference and collision.
- Exercise caution to keep the boom from contact with an operator and this machine when slewing it.
- If crane operational check detects an abnormal event, make an emergency stop promptly and repair a relevant part. Potential serious accident may occur if disregarded.
- Exercise caution not to drive on or entangle the cabtyre cable during crane traveling. Staff guide personnel as necessary, and follow the lead of them.
- Keep the Inverter unit cover away from flammable materials. The inside of the Inverter unit will rise in temperature that may lead to fire, if disregarded.

### CAUTION

- Proper temperature of hydraulic oil: 50 to 80°C  
The hydraulic oil should be at around 20°C regardless of operational environment such as low-temperature operation.
- Ensure that the main switch of the radio control box is turned OFF.

1. Set the engine and electric motor switch to the "Elec. Motor" position.

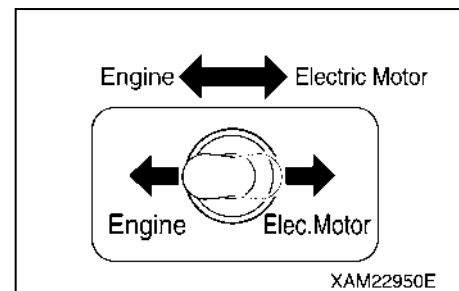

2. Insert the key into the starter switch and turn the key to the "START" position.

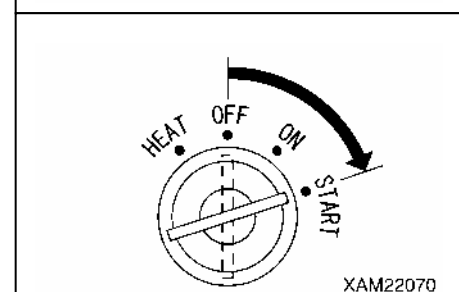

3. Release your hand from the key once the electric motor has started.

The key will automatically return to the "ON" position.

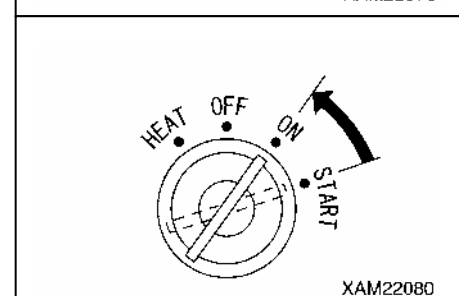

4. Conduct 5-minute warm-up after the electric motor is started.

## NOTES

This machine is structured to switch to the energy-saving mode if no lever operation is attempted within 5 minutes after the electric motor is started.

Once the energy-saving mode has been entered, the electric motor undergoes an extreme reduction in rotational speed. Operate any lever for recovery from the energy-saving mode. The electric motor comes to a stop if no lever operation is attempted within further 30 minutes after being started. Turn the starter switch to the "START" position again for recovery.

5. Visually check through the access protective cover of the Inverter unit that the trouble lamp remains OFF.

## CAUTION

**An error occurs in the Inverter unit, which causes the trouble lamp to come ON in red.**

**Contact us or our sales service agency to request inspection and repair in the above event.**

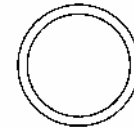

Trouble

XAM23010E

6. Use the following procedure for checking the power unit if an abnormal noise, odor, or vibration is present in and around the power unit.

(1) Turn the starter switch key to the "OFF" position.

The electric motor comes to a stop.

(2) Remove the four mounting bolts (2) securing the bottom of the power unit cover (1) and remove the power unit cover (1).

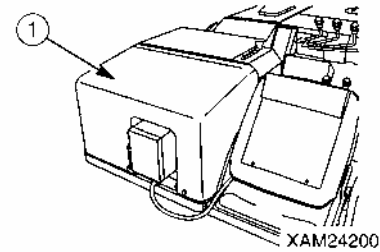

XAM24200

(3) Check the mounting bolts securing the electric motor (3) and hydraulic pump (4) for looseness and falling off, and check the coupling (5) for looseness.

If check finds looseness, torque the bolts to the specified value to provide retightening.

(4) Keep the periphery of the power unit free of dead leaves, paper waste, and dust.

Eliminate dead leaves, paper waste, and dust if heaped or adhered.

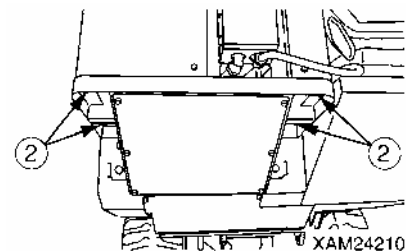

XAM24210

(5) Install the power unit cover (1) in inverse order of their removal upon completion of inspection and cleaning.

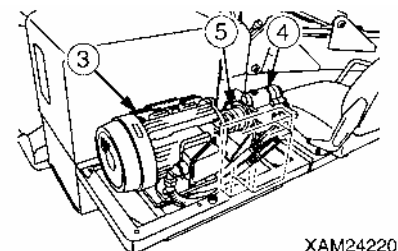

XAM24220

## 4.4 MACHINE OPERATION

### CAUTION

Perform crane operation referring to “Operation 2.5 Machine Traveling Posture” through “Operation 2.25 Dos and Don’ts during Crane Operations” after motor warm-up is completed.

## 4.5 MACHINE STOP AND CHECKS AFTER STOPPING MACHINE

1. Turn the starter switch key to the “OFF” position.  
The electric motor comes to a stop.
2. Remove the starter switch key.
3. Visibly check for oil leakage, and check around the crawlers, crane, and exterior of the machine. If you find any leakage or abnormality, fix the problem.
4. Clean off the crawlers and outriggers, removing mud.
5. Keep the periphery of the inverter unit free of dead leaves and paper waste. Potential fire may occur if disregarded.

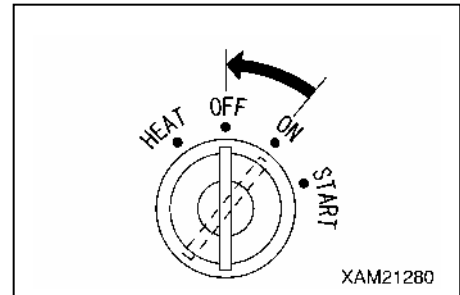

## 4.6 POWER SUPPLY SEPARATION (BETWEEN POWER SUPPLY EQUIPMENT AND MACHINE)

1. Turn OFF the power supply equipment breaker.
2. Remove the four mounting screws (11) and remove the protective cover (10).
3. Turn OFF the main breaker (1).
4. Replace the protective cover (10) to the original position and securely tighten four mounting screws (11).
5. Unlock the door (3) of the power supply box (2) by pulling the handle (4) toward you to open it.
6. Remove the cover (6) of the terminal block (5) in the power supply box, holding the top and bottom of the cover (6) with fingers and pulling it toward you.
7. Disconnect the cable (8) and three cables (9) of the cabtyre cable (A) from the terminal block (5).

### CAUTION

- Clean off the cabtyre cable and check it for damage or bend. If check finds damage, replace the cable with a new one.
- Always return the cabtyre cable to a designated place after performing inspection and cleaning.

8. Replace the cover (6) of the terminal block (5) to the original position and close the door (3) of the power supply box (2).

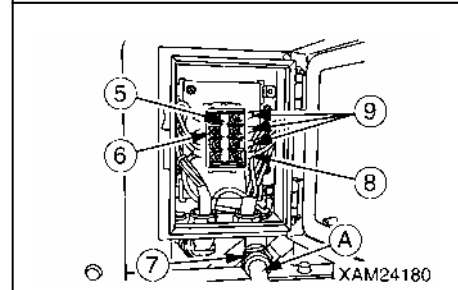
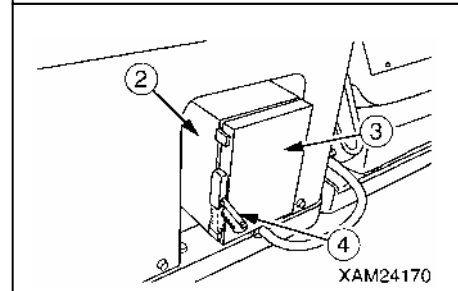
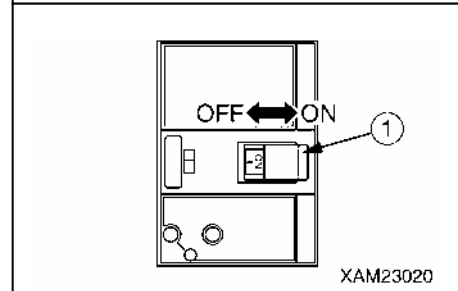
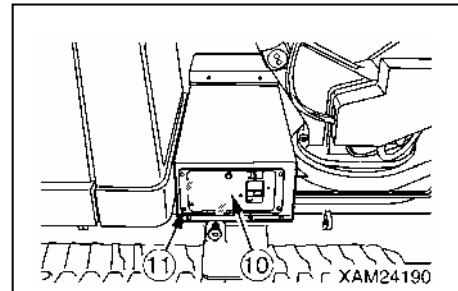

## 5. LONG-TERM STORAGE

### CAUTION

- See “Operation 7. Long-Term Storage” for long-term storage.
- This section describes only the long-term storage method that is not defined in standard specifications.

Use the following procedure for storing the machine for 6 months or longer (3 months or longer if stored in hot and humid surroundings).

- Cover the electric motor and hydraulic pump of the power unit with a plastic sheet. Keep the machine dry with a dehumidifying agent in the covered sheet.
- Conduct 5-minute idling of engine quarterly during long-term storage.

### CAUTION

- Quarterly insulation resistance test of electric motor wiring is required during long-term storage.  
Contact us or our sales service agency to request inspection in the above event.
- Insulation resistance test of electric motor wiring is required before resuming the machine after long-term storage.  
Contact us or our sales service agency to request inspection in the above event.

## 6. ELECTRIC MOTOR TROUBLESHOOTING

- Make sure that you contact us or our sales service agency for the actions indicated in parentheses in the Actions field.
- Ask our sales service agency for repair if you suspect other abnormality or causes than those given below.

| Abnormal Phenomenon   | Major Cause(s)  | Actions  |
|---|---|--|
| The motor remains off despite the switch being turned to the "START" position.  | <ul style="list-style-type: none"> <li>• Improper wiring and power supply error</li> <li>• The Inverter unit breakers: OFF</li> <li>• A break in stator winding</li> </ul>  | <ul style="list-style-type: none"> <li>• Check wiring, see "Engine &amp; Electric Motor Spec. 4. Operation".</li> <li>• Turn ON the breakers.</li> <li>(• Inspection, repair, replacement)</li> <li>(• Inspection, repair, replacement)</li> </ul>   |
| The motor comes to a stop during use.   | <ul style="list-style-type: none"> <li>• Inverter unit error (Red lamp: ON)</li> <li>• Failure in the Inverter unit</li> <li>• Failure in the power unit</li> </ul>   | <ul style="list-style-type: none"> <li>• Check the power supply source (voltage and phase interruption).</li> <li>(• Inspection, repair, replacement)</li> <li>(• Inspection, repair, replacement)</li> </ul>  |
| The power output of the motor reaches zero or undergoes gradual decrease.       | <ul style="list-style-type: none"> <li>• Phase interruption in the power source of power supply equipment</li> <li>• Slack in motor wiring</li> </ul>   | <ul style="list-style-type: none"> <li>• Check the power source of power supply equipment (voltage and phase interruption).</li> <li>• Inspect connection with the motor Terminal block .</li> <li>(• Inspection, repair, replacement)</li> </ul>  |
| The cabtyre cable rises in temperature.   | <ul style="list-style-type: none"> <li>• Considerable voltage drop</li> </ul>   | <ul style="list-style-type: none"> <li>• Ensure that the power supply voltage of power supply equipment is at a specified value.</li> <li>• Replace the cabtyre cable with one adhering to specifications.</li> </ul>  |
| An abnormal noise and vibration are present in the power unit during operation. | <ul style="list-style-type: none"> <li>• A break in motor winding</li> <li>• Looseness in the motor and pump fixing bolt</li> <li>• Looseness in the coupling fixing bolt</li> <li>• Impurities on the coupling</li> <li>• Clogging in the hydraulic oil tank strainer and element</li> </ul> | <ul style="list-style-type: none"> <li>• Inspect the motor Terminal block .</li> <li>(• Inspection, repair, replacement)</li> <li>• Perform inspection, repair, and cleaning. See "Engine &amp; Electric Motor Spec. 4. Operation" .</li> <li>(• Replacement)</li> <li>• Clean and replace the strainer and element according to periodic inspection.</li> </ul>           |
| The power unit rises in temperature during operation.                           | <ul style="list-style-type: none"> <li>• High ambient temperature</li> <li>• Ill-ventilated</li> <li>• Considerable voltage drop</li> <li>• Overload</li> <li>• High number of starts</li> </ul>  | <ul style="list-style-type: none"> <li>• Use the power unit in environment compliant with specifications.</li> <li>• Perform inspection and cleaning, See "Engine &amp; Electric Motor Specifications 4. Operation".</li> <li>• Replace the cabtyre cable with one adhering to specifications.</li> <li>• Reduce loads.</li> <li>• Reduce the number of starts.</li> </ul> |
| The leak detector of the Inverter unit main breaker is tripped.                 | <ul style="list-style-type: none"> <li>• High humidity</li> <li>• Presence of water droplets</li> <li>• Ill-grounded</li> <li>• A break in stator winding</li> </ul>  | <ul style="list-style-type: none"> <li>• Use the leak detector in environment compliant with specifications.</li> <li>• Attach the cover properly.</li> <li>• Adhere to ground standards.</li> <li>(• Inspection, repair, replacement)</li> </ul>  |
| The trouble lamp (red) of the Inverter unit comes on.                           | <ul style="list-style-type: none"> <li>• Failure in the Inverter unit</li> </ul>  | <ul style="list-style-type: none"> <li>(• Inspection, repair, replacement)</li> </ul>  |

## 7. PRINCIPLE SPECIFICATION LIST

| System / Item           |   | MC-305C-2 (Engine and Electric Motor Specifications)   |
|-------------------------|---|--|
| Mass and dimensions     | Machine mass                              | 4080kg   |
|                         | Overall length × width × height           | 4285mm x 1280mm x 1695mm   |
|                         | Distance between idler and sprocket       | 1750mm   |
|                         | Track gauge                               | 980mm  |
|                         | Track width                               | 300mm  |
| Capacity                | Maximum rated total load × working radius | 2.98t x 2.5m   |
|                         | Maximum working radius                    | 12.16m   |
|                         | Maximum lifting height                    | 12.52m   |
| Winch system            | Method                                    | Swash plate axial piston motor, planetary gear deceleration, friction plate brake  |
|                         | Winding speed                             | Engine operation: 13.5m/min, Electric operation: 9.125m/min (4th drum, 4 ropes)  |
|                         | Hoisting rope                             | IWRC 6 x WS (26) 0/0 Type B φ8 x 73m   |
| Boom telescoping system | Method                                    | Sequentially telescoping hydraulic cylinder (3 pieces) + Sheave-embedded wire rope expansion device (1 piece), (With a hydraulic automatic locking device)                                 |
|                         | Boom type                                 | Pentagonal section, hydraulic automatic extension, 5-stage boom (Stage 2/3: Sequentially telescoping, Stage 4/5: Simultaneous telescoping)   |
|                         | Boom length                               | 3.695m – 5.945m – 8.145m – 10.315m – 12.485m   |
|                         | Boom telescoping stroke/ time             | Engine operation: 8.79m/26sec<br>Electric operation: 8.79m/39.6sec   |
| Derrick system          | Method                                    | Direct push-type hydraulic double-acting cylinder (2 pieces), (With a hydraulic automatic locking device)  |
|                         | Derrick angle/ time                       | Engine operation: 0 to 80 deg./14.5sec,<br>Electric operation: 0 to 80 deg./19.9sec  |
| Slewing system          | Method                                    | Swing bearing, hydraulic motor drive,<br>Reduction gear: Worm + Reduction spur gear,<br>Brake: Worm-selflock   |
|                         | Slewing angle/ speed                      | Engine operation: 360 deg. (continuous)/ 25sec (2.4min <sup>-1</sup> )<br>Electric operation: 360 deg. (continuous)/ 36.7sec (1.6min <sup>-1</sup> )                                       |
| Outrigger system        | Method                                    | Extension/ground: Direct push-type hydraulic cylinder (With a hydraulic automatic locking device)  |
|                         | Overall width of extended outriggers      | (Front) 4504mm x (Right/left) 4888mm x (Rear) 4396mm   |
| Traveling system        | Method                                    | Hydraulic two-speed motor drive, Variable speed, Built-in brake  |
|                         | Travel speed                              | Forward/backward: 0 – 2.8km/h (engine operation)   |
|                         | Gradeability                              | 23 deg.  |
|                         | Ground pressure                           | 36.3kPa (0.37kgf/cm <sup>2</sup> )   |
| Hydraulic system        | Hydraulic pump                            | Engine operation: Double-throw variable piston pump (13cc/rev x 2)<br>Electric operation: Double-throw variable piston pump (8.6cc/rev x 2)  |
|                         | Rated pressure                            | Traveling: 20.6MPa (210kgf/cm <sup>2</sup> )<br>Crane high-pressure relief: 20.1MPa (205kgf/cm <sup>2</sup> )<br>Crane low-pressure relief: 4.41 to 6.37MPa (45 to 65kgf/cm <sup>2</sup> ) |
|                         | Hydraulic oil tank capacity               | 56L  |



| System / Item  |   | MC-305C-2 (Engine and Electric Motor Specifications)  |
|----------------|---|---|
| Engine         | Model   | Yanmar 3TNV76   |
|                | Type  | Vertical in-line 3-cylinder, Water cooled, 4-cycle (special vortex)   |
|                | Displacement  | 1.115L (1115cc)   |
|                | Rated output (continuous)   | 15.2kW/2500min <sup>-1</sup> (20.7PS/2500rpm)   |
|                | Fuel tank capacity  | Light oil/ 40L  |
| Battery        | Model   | 60B24R (DC12V x 1 piece)  |
| Electric motor | Motor specifications  | Three-phase induction motor: 5.5kW 4P 200. 220V 50Hz  |
|                | Starting method   | Inverter-controlled (30 to 60Hz), energy-saving mode available (Crane mode: 10-Hz operation after 5-minute consecutive no operation, automatic power off in 30 minutes) |
| Safety device  | Over hoist detector / automatic stop device, three-winding stop alarm / automatic stop device, load indicator, hydraulic safety valve, hydraulic automatic locking device, slinging rope detachment protector, alarm buzzer, audio alarm, level, crane tip-over alarm (an alarm issued in the event of the crane operation at 3-degree inclination and traveling at 15-degree inclination), traveling lever lock, traveling/crane/outrigger selector switch (designed to prevent the machine from craning at traveling), outrigger safety device (outrigger interlock and crane interlock), moment limiter (working envelope limited), working status lamp, outrigger non-installation warning lamp |   |

## 8. SPECIFICATION DIMENSINAL DRAWING

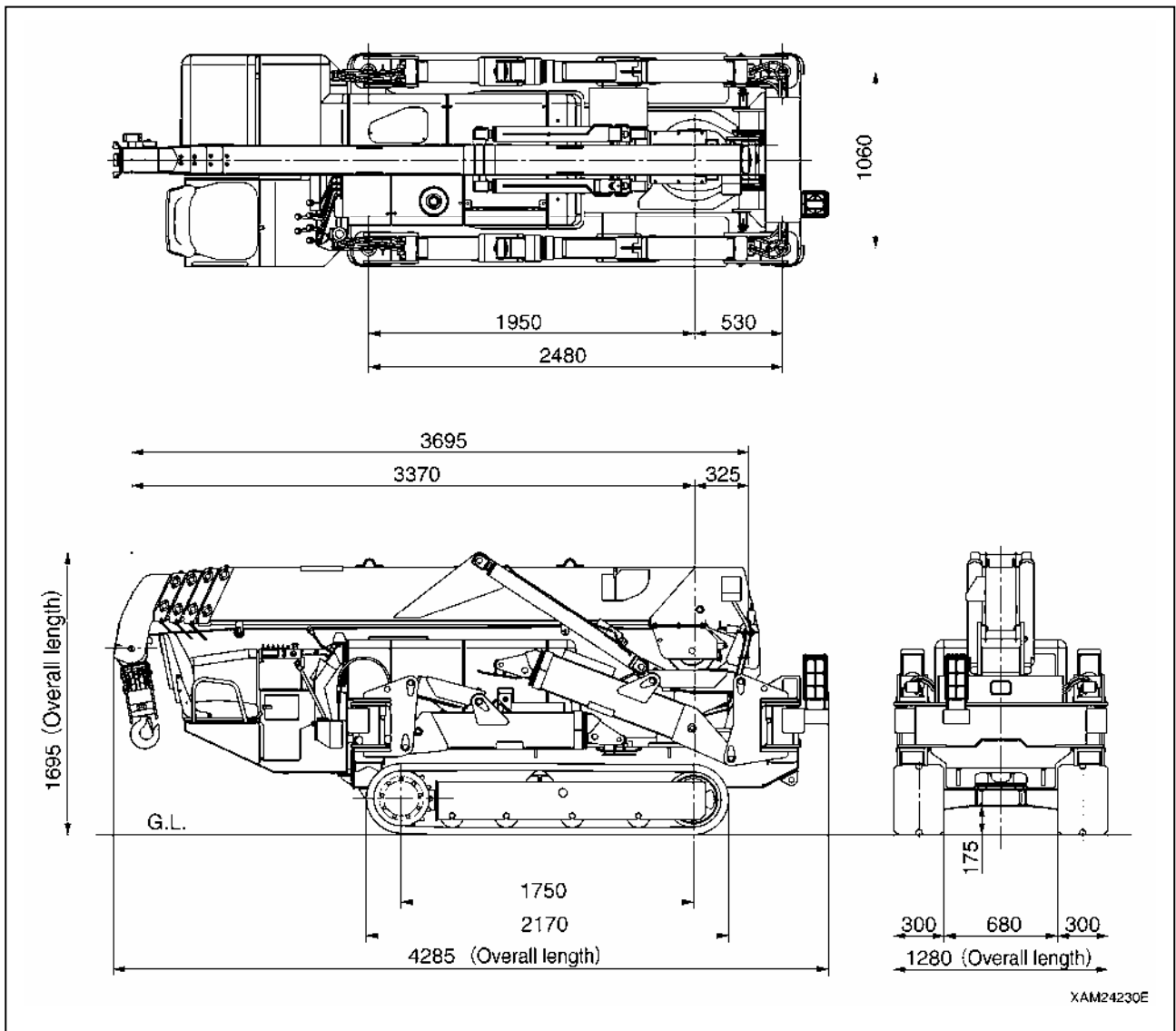

# SEARCHER HOOK

|  |      |
|--|------|
| 1. SEARCHER HOOK EACH SECTION          | 8- 2 |
| 2. MOMENT LIMITER DISPLAY UNIT         | 8- 4 |
| 3. OPERATION                           | 8- 6 |
| 4. INSPECTION AND MAINTENANCE          | 8- 8 |
| 5. WORKING RADIUS AND RATED TOTAL LOAD | 8-11 |

# 1. SEARCHER HOOK EACH SECTION

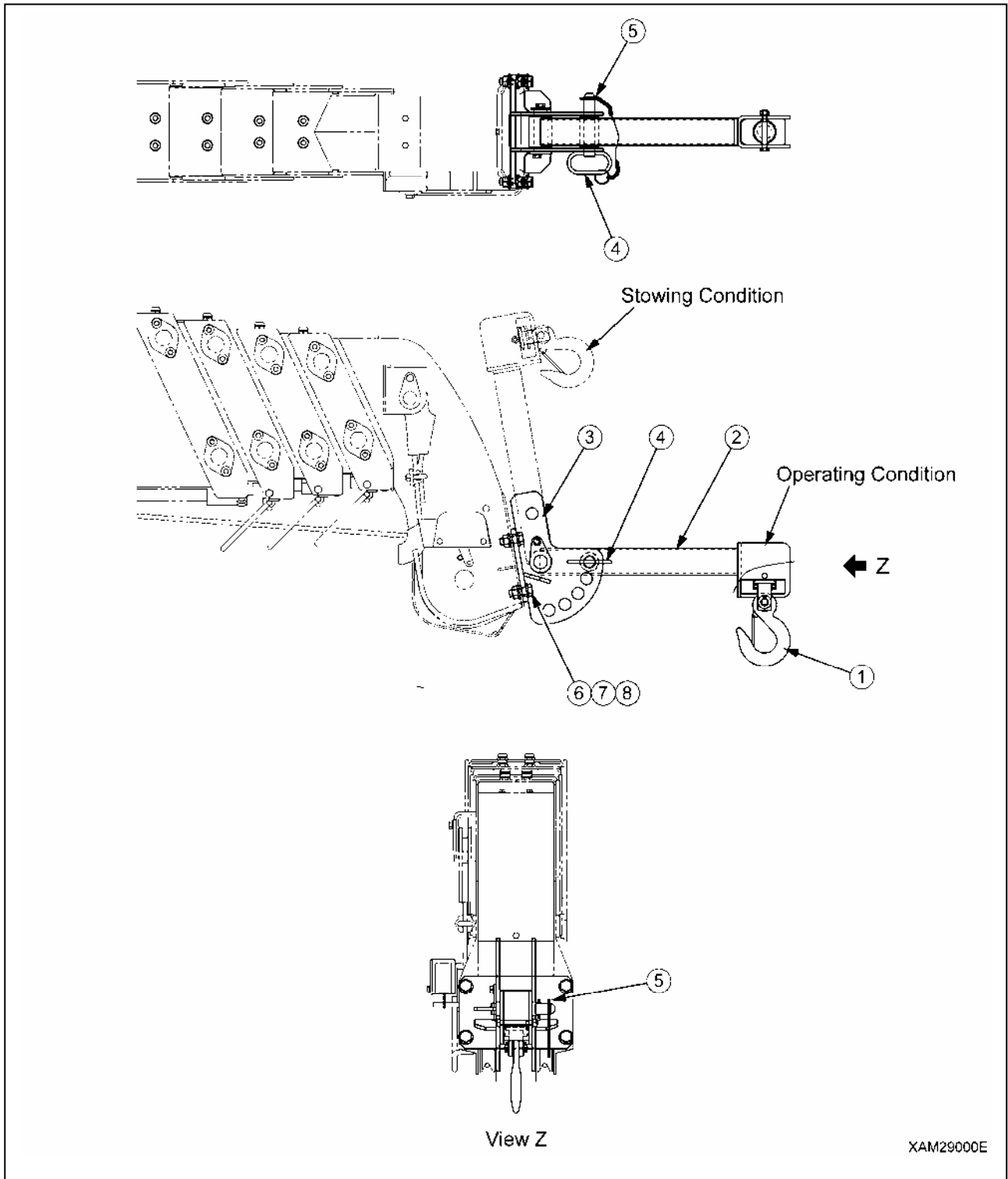

- (1) Hook
- (2) E-Boom
- (3) Bracket
- (4) Position pin

- (5) Snap pin
- (6) Hex. head bolt
- (7) Hex. head nut
- (8) High tension washer



## 2. MOMENT LIMITER DISPLAY UNIT

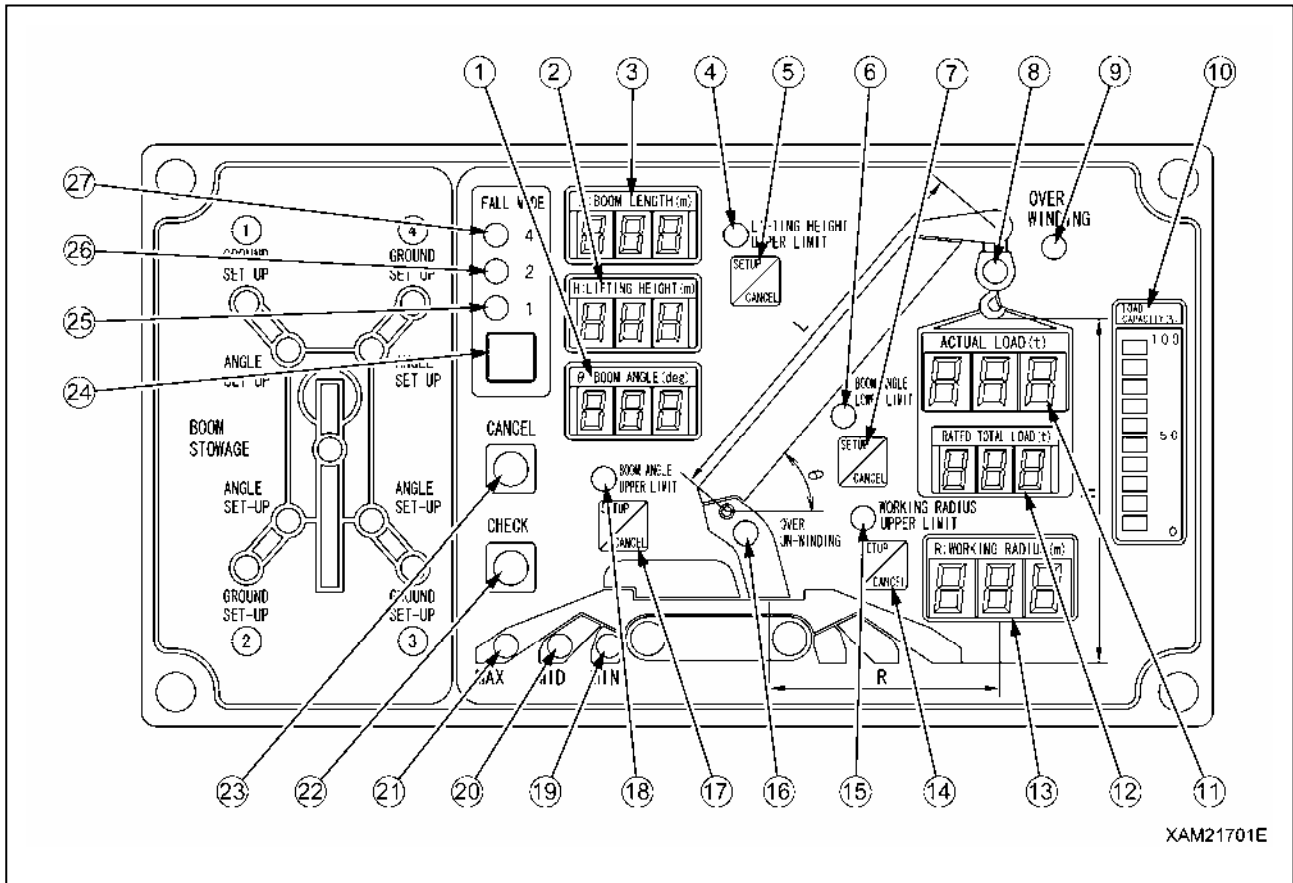

XAM21701E

- |  |  |
|--|--|
| (1) Boom angle display                                     | (14) Working radius upper limit switch       |
| (2) Lifting height display                                 | (15) Working radius upper limit LED (Orange) |
| (3) Boom length display                                    | (16) Over un-winding LED (Orange)            |
| (4) Boom lifting height upper limit LED (Orange)           | (17) Boom angle upper limit switch           |
| (5) Boom lifting height upper limit switch                 | (18) Boom angle upper limit LED (Orange)     |
| (6) Boom angle lower limit LED (Orange)                    | (19) Outrigger MIN. extension LED (Blue)     |
| (7) Boom angle lower limit switch                          | (20) Outrigger MID. extension LED (Blue)     |
| (8) Load factor LED<br>(Changes to green, yellow, and red) | (21) Outrigger MAX. extension LED (Blue)     |
| (9) Over hoist detection LED (Red)                         | (22) Check switch                            |
| (10) Load capacity display (Yellow)                        | (23) Cancel switch                           |
| (11) Actual load display                                   | (24) Fall mode selector switch               |
| (12) Rated total load display                              | (25) 1-fall fall LED (Blue)                  |
| (13) Working radius display                                | (26) 2-falls fall LED (Blue)                 |
|  | (27) 4-falls fall LED (Blue)                 |

For general operation, see "OPERATION 1.6 MORMENT LIMITER".

## [1] DESCRIPTIONS OF SWITCHES ON MOMENT LIMITER DISPLAY UNIT

### CAUTION

Refer “OPERATION 1.6 MOMENT LIMITER” section for switches other than the “WIRE FALLS SELECTOR SWITCH AND WIRE AND WIRE FALLS DISPLAY LED” shown in the next section.

### 1. WIRE FALLS SELECTOR SWITCH AND WIRE FALLS DISPLAY LED (BLUE)

#### ⚠ DANGER

Fall mode must be set as “Searcher hook mode” when operating searcher hook. Using searcher hook other than in “Searcher hook mode” may prevent issuance of the pre-warnings and boom auto-stop even when the overload is near happening, and thus may result in crane damage or machine trip that may result in serious accidents.

Use this switch to change the number of wire falls.

- Keep pressing the switch for 2 seconds or more.  
The setting changes from “4-falls” to “Searcher hook mode”. At the same time, the wire falls display LED changes from “4-falls” to “Searcher hook mode (all lights ON)”, indicating that the setting has changed.
- Then each time you press the switch for 2 seconds or more, the setting of the wire falls changes from “Searcher hook mode” to “1-fall”, then “1-fall” to “2-falls”, and then “2-falls” to “4-falls”.

#### NOTES

When changing the setting right after doing so, release your hand from the switch, and then press the switch again.

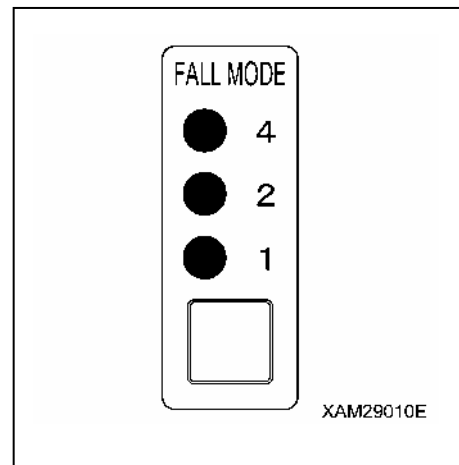

### 3. OPERATION

1. See "OPERATION 2.14 OUTRIGGER SETTING OPERATION" and set the outrigger.

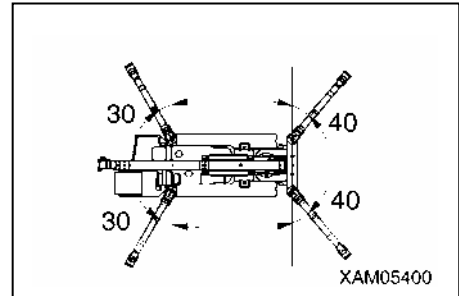

2. Fasten searcher bracket (3) to main-boom using 4 sets of M12 bolts and nuts. Tighten the bolts with torque wrench (B) them to torque of 93Nm ( $\pm 13$ Nm).

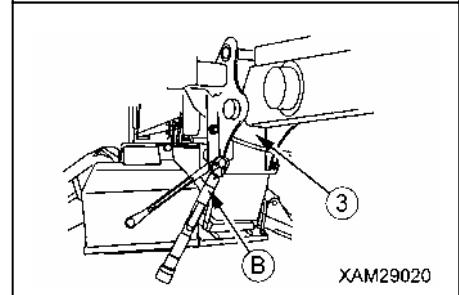

#### **⚠ DANGER**

- To prevent searcher hook to fall off, be sure to tighten and fix searcher hook fix bolt at tightening torque of 93Nm.
- Check that bolt is not cracked, squashed, or stretched before use.

3. Shift the wire falls selector switch on moment limiter display unit to "Searcher hook mode" (all LED ON).

#### **⚠ DANGER**

Fall mode must be set as "Searcher hook mode" when operating searcher hook. Using searcher hook other than in "Searcher hook mode" may prevent issuance of the pre-warnings and boom auto-stop even when the overload is near happening, and thus may result in crane damage or machine trip that may result in serious accidents.

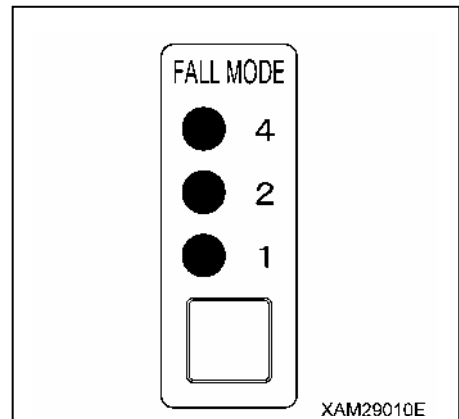

4. Remove the snap pin (5) from the end of position pin (4) of bracket (3), and remove the position pin (4).

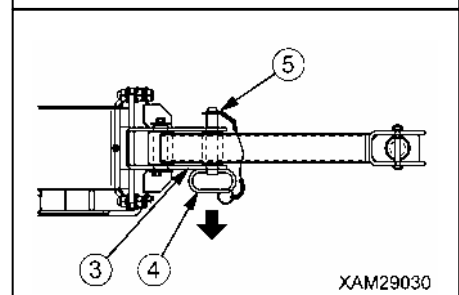

5. Move E boom (2) to the required angle for the work, and line up the holes in the E boom (2) and bracket (3).

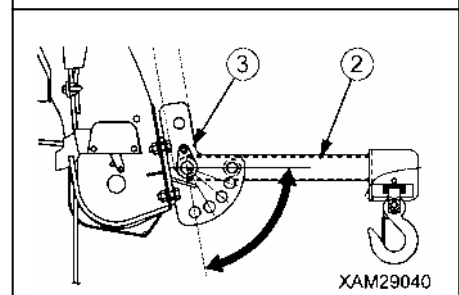

6. Insert the position pin (4) through the hole of bracket (3), and secure it with the snap pin (5) to the tip of position pin (4).

**⚠ DANGER**

Always secure the position pin (4) with the snap pin (5). If the snap pin falls out during operations, serious injury or damage to the machine may result.

7. Attach the load securely to the hook (1) and start operations.

**⚠ WARNING**

Always work in accordance with all appropriate local regulations concerning your own and others' safety.

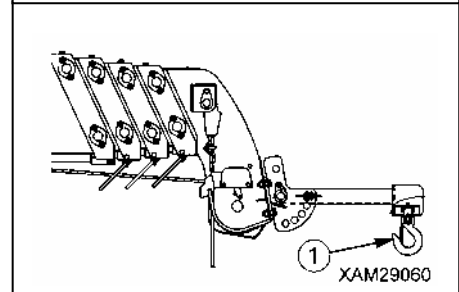
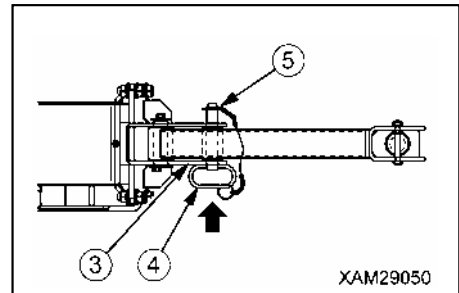



## 4. INSPECTION AND MAINTENANCE

### 4.1 LEGAL INSPECTION

In the event that federal or local law or regulation requires regular inspection to maintain safe operation of machine, check items below:

1. Check disorder of safety devices.
2. Check disorder of lifting equipment such as hook blocks.
3. Check damage to winch wire rope end and wire clips.
4. Replace wire rope immediately when any damage is detected.
5. Check cracks or deformations of structure members such as boom.
6. Check loose or missing of fasteners and fittings.
7. Check correct motion and stoppage of winch by actual operation.

In the event that such inspections detect any disorder, contact our sales partner. near-by.

### 4.2 CONSUMABLES

Wire rope and searcher hook fix bolt are consumption articles. Replace it at periodic inspection or before it reaches abrasion limits. Replace consumption articles regularly, which shall produce economical use of this machine. Always replace to our genuine item. Check parts catalog for correct part number for parts request.

#### [CONSUMABLES LIST]

| Part                                  | Replacement cycle  |
|---------------------------------------|--|
| Winch wire rope                       | # Based on wire rope exchange standard                     |
| Searcher hook fix bolt M12x30L (4pcs) | # Every 6 months or when damage, crack, or squash is found |

★The cycles marked with a star “#” in Replacement cycle include a halt period.

★Contact us or our sales service agency for part replacement.

### 4.3 INSPECTION AND MAINTENANCE LIST

This document only covers searcher hook kit. For crane body, please refer to “Inspection and Maintenance” and follow its precautions.

| Inspection and maintenance items                               | Page |
|--|------|
| <b>4.4.1 INSPECTION OF BEFORE OPERATION</b>                    | 8- 9 |
| <b>[CHECKING BEFORE STARTING ENGINE]</b>                       | 8- 9 |
| [1] CHECKING BOOM AND BRACKET                                  | 8- 9 |
| [2] CHECKING SEARCHER HOOK FIX BOLTS                           | 8- 9 |
| [3] CHECKING ELECTRICAL WIRING FOR DAMAGE                      | 8- 9 |
| <b>[CHECKING AFTER STARTING ENGINE]</b>                        | 8-10 |
| [1] CHECKING FUNCTIONS OF BOOM                                 | 8-10 |
| [2] CHECKING MOMENT LIMITER FOR OPERATION (SEARCHER HOOK MODE) | 8-10 |

## 4.4 MAINTENANCE PROCEDURES

### 4.4.1 INSPECTION OF BEFORE OPERATION

#### [CHECKING BEFORE STARTING ENGINE]

Check the followings in this section without starting the engine and before starting the first work every day.

#### [1] CHECKING BOOM AND FRAME

- Check each part of the boom and frame for cracks, excessive deformation, contamination and others. In addition, check bolts, nuts and pins for any looseness, drop, damage and other matters. If you find any abnormality, repair.

#### [2] CHECKING SEARCHER HOOK FIX BOLTS

### ⚠ DANGER

**If any damage found on searcher hook fix bolt, please exchange it to new one right away. Breakage of bolt cause searcher hook to fall off.**

- Check if there is crack, damage, or squash on screw thread on screw part of bolt.  
If crack, damage or squash on screw thread is found, change the bolt to new one even it is earlier than expected bolt life.

#### [3] CHECKING ELECTRICAL WIRING (FUSE BOX) FOR DAMAGE

### ⚠ WARNING

**If fuses are brown frequently or if you find the trace of a short circuit created in the electrical wiring, be sure to find the cause and fix the problem.**

Check the fuse at the lower section of the instrument panel for damage and meltdown and if the fuse of specified capacity is being used.

If a fuse has melted down or the trace of an open/short circuit is found in the electrical wiring, ask us or our sales service agency for repair.

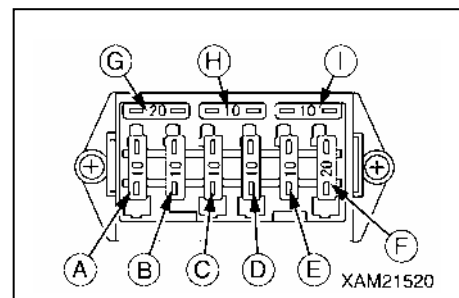

**[CHECKING AFTER STARTING ENGINE]**

Check the followings in this section after starting the engine and before starting the first work every day.

**CAUTION**

The checkups described in this section should be carried out after starting the machine. Refer to "Operation 2.2 Starting Engine" and later to execute the engine startup, traveling operations, outrigger operations and crane operations.

**[1] CHECKING FUNCTIONS OF BOOM**

**WARNING**

At the performance of function check for boom, ensure the safety such that hook and boom would not interfere with any personnel nor object.

1. Check abnormal noise from boom and searcher hook during crane operation.
2. Operate crane without load and check loose and missing of each bolt.
3. Check hook for deformation, abnormal noise from bearing and correct function of wire rope latch (1).

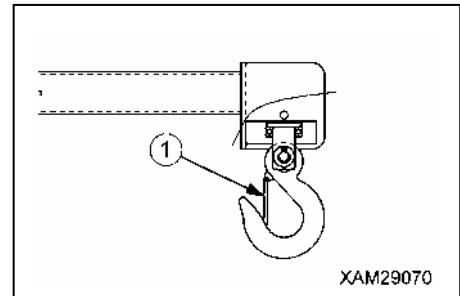

**[2] CHECKING MOMENT LIMITER FOR OPERATION (SEARCHER HOOK MODE)**

**WARNING**

If you find any abnormality with the moment limiter, immediately contact us or our sales service agency.

1. Turn the starter switch to the "ON" position.
2. Check with the working status lamp. The red of the lamp lights up for 2 seconds and then the green lights up.
3. Check the moment limiter display unit.  
Verify that no error code is displayed at the "RATED TOTAL LOAD" display on the display panel.
4. Shift the wire falls selector switch on moment limiter display unit to "Searcher hook mode" (all LED ON).
5. Start the engine and operate the crane as follows to verify if the moment limiter properly displays the value.

| Crane Operation and Displayed Parameter  | Value Displayed on Moment Limiter |
|--|-----------------------------------|
| Displayed "boom length" with the boom length at minimum  | 3.7 m                             |
| Displayed "boom length" with the boom length at maximum  | 12.5 m                            |
| Displayed "working radius" with the boom length of "5.9 m" (2-row booms) and boom angle of "57 °"  | 3.0 ± 0.1 m                       |
| Displayed "ACTUAL LOAD" when the weight of the known weight was hoisted<br>★Must be equal to the total weight of weight + lifting ring<br>★Note that it may show some errors depending on the boom conditions. | Actual load                       |

6. Operate the crane until the moment limiter display values indicate the boom length is "5.9 m" (booms (1) + (2)) and boom angle is "57 degrees", then measure the "boom angle" and "working radius".  
If the measured value(s) differ from the moment limiter display value, contact us or our sales agency.

## 5. WORKING RADIUS AND RATED TOTAL LOAD

### ⚠ DANGER

- When using the searcher hook, be sure to set searcher hook mode for moment limiter.
- Must not use the searcher hook and the crane hook simultaneously.

### 5.1 WORKING RADIUS AND LIFTING HEIGHT FOR SEARCHER HOOK

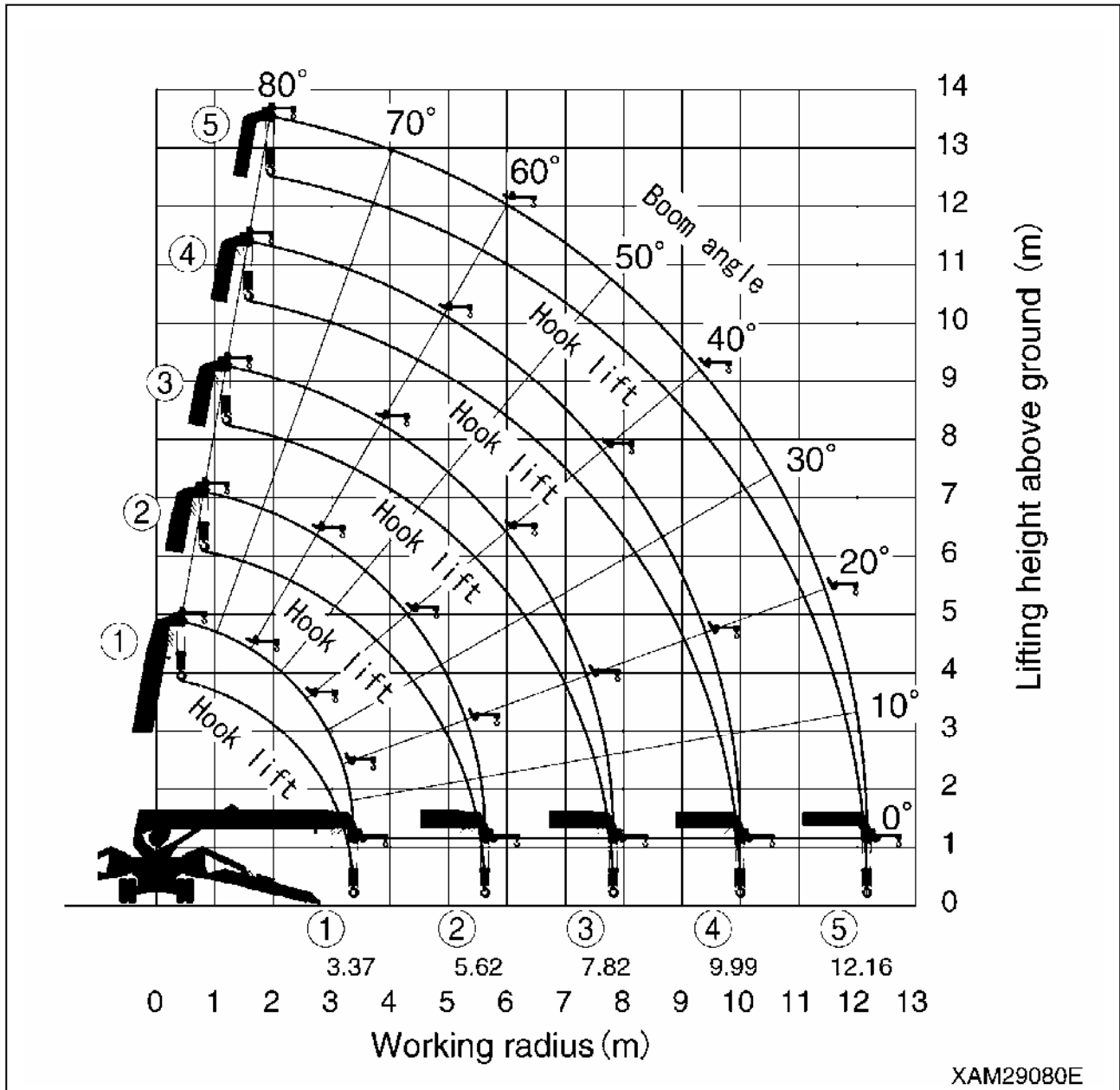

## 5.2 RATED TOTAL LOAD CHART FOR SEARCHER HOOK

| Rated total load Chart |                       |                    |                       |                    |                       |                    |                       |
|------------------------|-----------------------|--------------------|-----------------------|--------------------|-----------------------|--------------------|-----------------------|
| 5.945m BOOM            |                       | 8.145m BOOM        |                       | 10.315m BOOM       |                       | 12.485m BOOM       |                       |
| Working radius (m)     | Rated total load (kg) | Working radius (m) | Rated total load (kg) | Working radius (m) | Rated total load (kg) | Working radius (m) | Rated total load (kg) |
| 2.50 or less           | 300                   | 2.70 or less       | 300                   | 4.00 or less       | 300                   | 4.50 or less       | 300                   |
| 3.00                   | 300                   | 3.00               | 300                   | 4.50               | 300                   | 5.00               | 300                   |
| 3.50                   | 300                   | 3.50               | 300                   | 5.00               | 300                   | 6.00               | 300                   |
| 4.00                   | 300                   | 4.00               | 300                   | 6.00               | 300                   | 7.00               | 250                   |
| 4.50                   | 300                   | 4.50               | 300                   | 7.00               | 300                   | 8.00               | 200                   |
| 5.00                   | 300                   | 5.00               | 300                   | 8.00               | 300                   | 9.00               | 200                   |
| 5.62                   | 300                   | 5.50               | 300                   | 9.00               | 300                   | 10.00              | 150                   |
| --                     | --                    | 6.00               | 300                   | 9.99               | 250                   | 11.00              | 150                   |
| --                     | --                    | 7.00               | 300                   | --                 | --                    | 12.16              | 150                   |
| --                     | --                    | 7.82               | 300                   | --                 | --                    | --                 | --                    |

# 850kg SEARCHER HOOK

|  |      |
|--|------|
| 1. SAFETY DECAL LOCATIONS              | 9- 2 |
| 2. SEARCHER HOOK EACH SECTION          | 9- 5 |
| 3. MOMENT LIMITER DISPLAY UNIT         | 9- 6 |
| 4. OPERATION                           | 9-10 |
| 5. INSPECTION AND MAINTENANCE          | 9-14 |
| 6. WORKING RADIUS AND RATED TOTAL LOAD | 9-18 |

# 1. SAFETY DECAL LOCATIONS

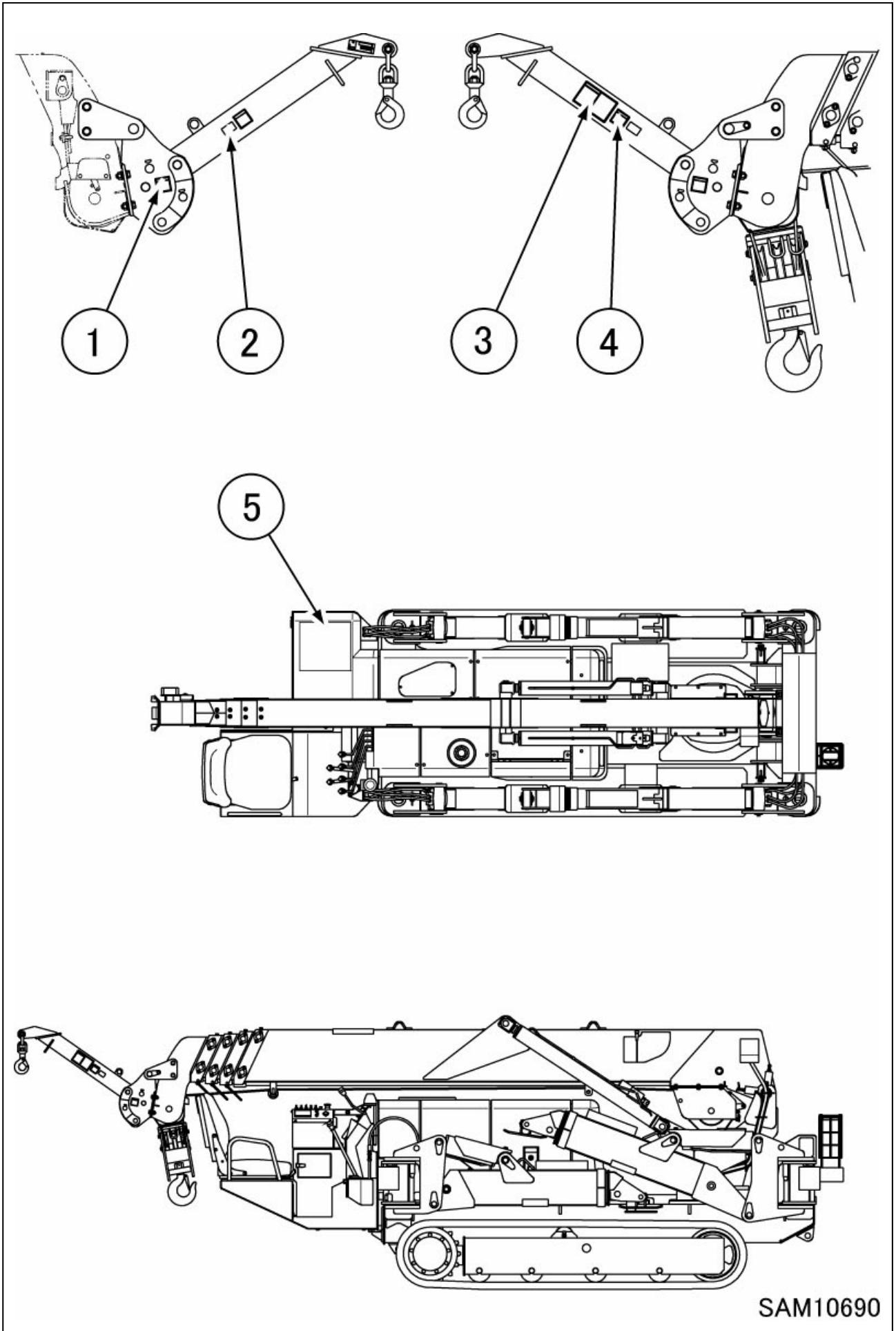



①102-4608500



②102-4621200

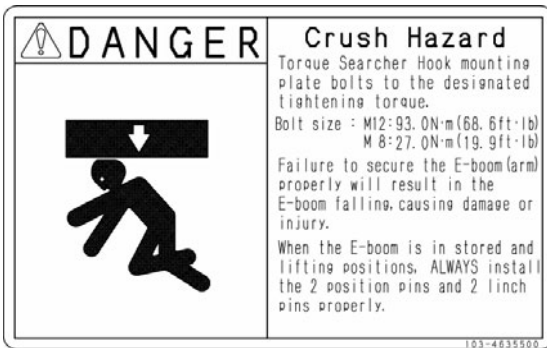

③103-4635500



④103-4635800



NC305C-2 OPERATING RANGE for 850kg SEARCHER HOOK

RATED TOTAL LOAD CHART for 850kg SEARCHER HOOK The unit of loads:kg

OFFSET POSITION SH1

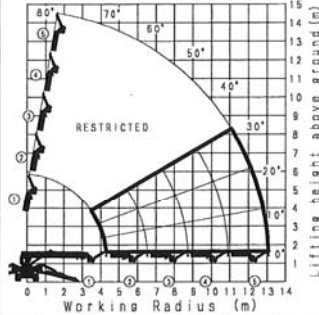

| Working Radius (m) | ① 3.695m BOOM           |                    |     |     | ② 5.945m BOOM |                         |                    |     | ③ 8.145m BOOM |     |                         |                    | ④ 10.315m BOOM |     |     |                         | ⑤ 12.485m BOOM     |     |     |     |                         |                    |     |     |     |
|--------------------|-------------------------|--------------------|-----|-----|---------------|-------------------------|--------------------|-----|---------------|-----|-------------------------|--------------------|----------------|-----|-----|-------------------------|--------------------|-----|-----|-----|-------------------------|--------------------|-----|-----|-----|
|                    | LOADED BOOM ANGLE (deg) | OUTRIGGER POSITION | MAX | MID | MIN           | LOADED BOOM ANGLE (deg) | OUTRIGGER POSITION | MAX | MID           | MIN | LOADED BOOM ANGLE (deg) | OUTRIGGER POSITION | MAX            | MID | MIN | LOADED BOOM ANGLE (deg) | OUTRIGGER POSITION | MAX | MID | MIN | LOADED BOOM ANGLE (deg) | OUTRIGGER POSITION | MAX | MID | MIN |
| 3.5                | 29.5                    | RESTRICTED         | 850 | 850 | 850           | 30.0 OR MORE            | RESTRICTED         | 850 | 850           | 850 | 30.0 OR MORE            | RESTRICTED         | 850            | 850 | 850 | 30.0 OR MORE            | RESTRICTED         | 850 | 850 | 850 | 30.0 OR MORE            | RESTRICTED         | 850 | 850 | 850 |
| 4.3                | 0.0                     | 850                | 850 | 850 |               |                         |                    |     |               |     |                         |                    |                |     |     |                         |                    |     |     |     |                         |                    |     |     |     |
| 5.5                |                         |                    |     |     |               |                         |                    |     |               |     |                         |                    |                |     |     |                         |                    |     |     |     |                         |                    |     |     |     |
| 6.5                |                         |                    |     |     |               |                         |                    |     |               |     |                         |                    |                |     |     |                         |                    |     |     |     |                         |                    |     |     |     |
| 7.4                |                         |                    |     |     |               |                         |                    |     |               |     |                         |                    |                |     |     |                         |                    |     |     |     |                         |                    |     |     |     |
| 8.0                |                         |                    |     |     |               |                         |                    |     |               |     |                         |                    |                |     |     |                         |                    |     |     |     |                         |                    |     |     |     |
| 8.7                |                         |                    |     |     |               |                         |                    |     |               |     |                         |                    |                |     |     |                         |                    |     |     |     |                         |                    |     |     |     |
| 9.3                |                         |                    |     |     |               |                         |                    |     |               |     |                         |                    |                |     |     |                         |                    |     |     |     |                         |                    |     |     |     |
| 10.5               |                         |                    |     |     |               |                         |                    |     |               |     |                         |                    |                |     |     |                         |                    |     |     |     |                         |                    |     |     |     |
| 11.2               |                         |                    |     |     |               |                         |                    |     |               |     |                         |                    |                |     |     |                         |                    |     |     |     |                         |                    |     |     |     |
| 12.0               |                         |                    |     |     |               |                         |                    |     |               |     |                         |                    |                |     |     |                         |                    |     |     |     |                         |                    |     |     |     |
| 13.1               |                         |                    |     |     |               |                         |                    |     |               |     |                         |                    |                |     |     |                         |                    |     |     |     |                         |                    |     |     |     |

OFFSET POSITION SH2

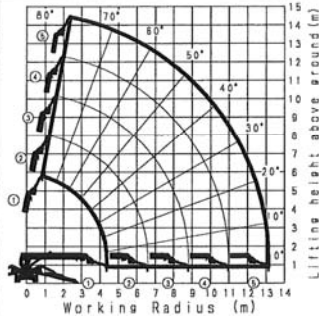

| Working Radius (m) | ① 3.695m BOOM           |                    |     |     | ② 5.945m BOOM |                         |                    |     | ③ 8.145m BOOM |     |                         |                    | ④ 10.315m BOOM |     |     |                         | ⑤ 12.485m BOOM     |     |     |     |                         |                    |     |     |     |
|--------------------|-------------------------|--------------------|-----|-----|---------------|-------------------------|--------------------|-----|---------------|-----|-------------------------|--------------------|----------------|-----|-----|-------------------------|--------------------|-----|-----|-----|-------------------------|--------------------|-----|-----|-----|
|                    | LOADED BOOM ANGLE (deg) | OUTRIGGER POSITION | MAX | MID | MIN           | LOADED BOOM ANGLE (deg) | OUTRIGGER POSITION | MAX | MID           | MIN | LOADED BOOM ANGLE (deg) | OUTRIGGER POSITION | MAX            | MID | MIN | LOADED BOOM ANGLE (deg) | OUTRIGGER POSITION | MAX | MID | MIN | LOADED BOOM ANGLE (deg) | OUTRIGGER POSITION | MAX | MID | MIN |
| 2.7                | 54.5                    | 850                | 850 | 850 | 67.5          | 850                     | 850                | 850 | 73.0          | 850 | 850                     | 850                | 76.5           | 850 | 850 | 850                     |                    |     |     |     |                         |                    |     |     |     |
| 4.0                | 27.0                    | 850                | 850 | 850 | 54.5          | 850                     | 850                | 850 | 64.0          | 850 | 850                     | 850                | 68.0           | 850 | 850 | 850                     |                    |     |     |     |                         |                    |     |     |     |
| 4.3                | 13.0                    | 850                | 850 | 850 | 51.5          | 850                     | 850                | 850 | 63.0          | 850 | 850                     | 850                | 66.0           | 850 | 850 | 850                     |                    |     |     |     |                         |                    |     |     |     |
| 4.5                |                         |                    |     |     | 49.0          | 850                     | 850                | 850 | 60.5          | 850 | 850                     | 850                | 66.5           | 850 | 850 | 850                     |                    |     |     |     |                         |                    |     |     |     |
| 5.0                |                         |                    |     |     | 43.0          | 850                     | 850                | 850 | 58.5          | 850 | 850                     | 850                | 64.0           | 850 | 830 | 830                     |                    |     |     |     |                         |                    |     |     |     |
| 6.0                |                         |                    |     |     | 27.0          | 850                     | 850                | 740 | 48.5          | 850 | 820                     | 680                | 58.0           | 710 | 700 | 650                     |                    |     |     |     |                         |                    |     |     |     |
| 6.6                |                         |                    |     |     | 0.0           | 850                     | 710                | 580 | 43.0          | 770 | 800                     | 570                | 54.0           | 660 | 650 | 570                     |                    |     |     |     |                         |                    |     |     |     |
| 7.0                |                         |                    |     |     |               |                         |                    |     | 38.0          | 720 | 620                     | 520                | 51.5           | 630 | 600 | 520                     |                    |     |     |     |                         |                    |     |     |     |
| 8.0                |                         |                    |     |     |               |                         |                    |     | 28.5          | 590 | 470                     | 380                | 44.5           | 550 | 490 | 410                     |                    |     |     |     |                         |                    |     |     |     |
| 8.8                |                         |                    |     |     |               |                         |                    |     | 0.0           | 520 | 420                     | 340                | 38.0           | 480 | 410 | 340                     |                    |     |     |     |                         |                    |     |     |     |
| 10.0               |                         |                    |     |     |               |                         |                    |     |               |     |                         |                    | 26.0           | 410 | 330 | 270                     |                    |     |     |     |                         |                    |     |     |     |
| 11.0               |                         |                    |     |     |               |                         |                    |     |               |     |                         |                    | 8.0            | 360 | 280 | 240                     |                    |     |     |     |                         |                    |     |     |     |
| 12.0               |                         |                    |     |     |               |                         |                    |     |               |     |                         |                    |                |     |     |                         |                    |     |     |     |                         |                    |     |     |     |
| 13.1               |                         |                    |     |     |               |                         |                    |     |               |     |                         |                    |                |     |     |                         |                    |     |     |     |                         |                    |     |     |     |

OFFSET POSITION SH3

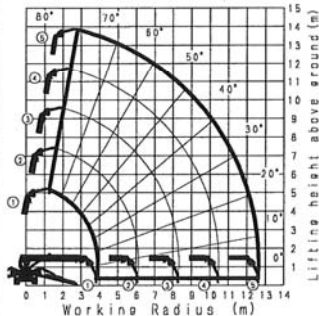

| Working Radius (m) | ① 3.695m BOOM           |                    |     |     | ② 5.945m BOOM |                         |                    |     | ③ 8.145m BOOM |     |                         |                    | ④ 10.315m BOOM |     |     |                         | ⑤ 12.485m BOOM     |     |     |     |                         |                    |     |     |     |
|--------------------|-------------------------|--------------------|-----|-----|---------------|-------------------------|--------------------|-----|---------------|-----|-------------------------|--------------------|----------------|-----|-----|-------------------------|--------------------|-----|-----|-----|-------------------------|--------------------|-----|-----|-----|
|                    | LOADED BOOM ANGLE (deg) | OUTRIGGER POSITION | MAX | MID | MIN           | LOADED BOOM ANGLE (deg) | OUTRIGGER POSITION | MAX | MID           | MIN | LOADED BOOM ANGLE (deg) | OUTRIGGER POSITION | MAX            | MID | MIN | LOADED BOOM ANGLE (deg) | OUTRIGGER POSITION | MAX | MID | MIN | LOADED BOOM ANGLE (deg) | OUTRIGGER POSITION | MAX | MID | MIN |
| 2.5                | 60.0                    | 850                | 850 | 850 | 72.0          | 850                     | 850                | 850 | 75.5          | 850 | 850                     | 850                |                |     |     |                         |                    |     |     |     |                         |                    |     |     |     |
| 2.7                | 56.5                    | 850                | 850 | 850 | 70.0          | 850                     | 850                | 850 | 73.5          | 850 | 850                     | 850                |                |     |     |                         |                    |     |     |     |                         |                    |     |     |     |
| 3.0                | 50.5                    | 850                | 850 | 850 | 67.0          | 850                     | 850                | 850 | 70.5          | 850 | 850                     | 850                |                |     |     |                         |                    |     |     |     |                         |                    |     |     |     |
| 3.8                | 25.0                    | 850                | 850 | 850 | 58.0          | 850                     | 850                | 850 | 67.5          | 850 | 850                     | 850                |                |     |     |                         |                    |     |     |     |                         |                    |     |     |     |
| 4.0                |                         |                    |     |     | 56.0          | 850                     | 850                | 850 | 66.0          | 850 | 850                     | 850                |                |     |     |                         |                    |     |     |     |                         |                    |     |     |     |
| 4.5                |                         |                    |     |     | 49.5          | 850                     | 850                | 850 | 62.0          | 850 | 850                     | 850                |                |     |     |                         |                    |     |     |     |                         |                    |     |     |     |
| 5.0                |                         |                    |     |     | 42.5          | 850                     | 850                | 850 | 58.0          | 850 | 850                     | 850                |                |     |     |                         |                    |     |     |     |                         |                    |     |     |     |
| 6.1                |                         |                    |     |     | 13.0          | 850                     | 830                | 710 | 48.0          | 840 | 800                     | 660                | 58.5           | 700 | 690 | 640                     |                    |     |     |     |                         |                    |     |     |     |
| 7.0                |                         |                    |     |     |               |                         |                    |     | 38.0          | 720 | 620                     | 520                | 57.0           | 630 | 600 | 520                     |                    |     |     |     |                         |                    |     |     |     |
| 8.3                |                         |                    |     |     |               |                         |                    |     | 9.0           | 560 | 450                     | 370                | 47.0           | 520 | 460 | 380                     |                    |     |     |     |                         |                    |     |     |     |
| 9.0                |                         |                    |     |     |               |                         |                    |     |               |     |                         |                    | 35.0           | 470 | 380 | 330                     |                    |     |     |     |                         |                    |     |     |     |
| 10.4               |                         |                    |     |     |               |                         |                    |     |               |     |                         |                    | 11.5           | 380 | 310 | 260                     |                    |     |     |     |                         |                    |     |     |     |
| 11.0               |                         |                    |     |     |               |                         |                    |     |               |     |                         |                    |                |     |     |                         |                    |     |     |     |                         |                    |     |     |     |
| 12.6               |                         |                    |     |     |               |                         |                    |     |               |     |                         |                    |                |     |     |                         |                    |     |     |     |                         |                    |     |     |     |

**DANGER**  
**TIPPING HAZARD**  
 When using searcher hook, Moment limiter "number of fall" must be set to 850kg searcher hook mode, and select searcher hook offset position.  
 Before start working, always make sure moment limiter is correctly set to the actual working condition.  
 Do not use searcher hook and main hoist hook block/ball simultaneously to hoist load.

**Notes:**  
 1. This Rated Total Load Chart shows maximum allowable capacities. These rated total loads are based on the machine standing level on a firm ground supporting surface, under ideal job conditions and a freely suspended load.  
 2. Sufficient design tolerance must be used to ensure adequate ground support surface design. The rated total loads are for static conditions only, and do not include dynamic effects of slewing, extending, retracting, lowering, raising, wind or adverse conditions. Crane users must reduce rated total loads ratings to take all conditions into account.  
 3. The working radius shown in the Rated Total Load Chart is based on practical working radius including boom deflection due to loading. The crane user must calculate and compensate for boom deflection as the load is lifted.  
 4. Deductions from Searcher Hook Rated Total Load must be made for the weight of the searcher hook, block/ball and all risings.  
 5. All capacities above the bold line are based on structural strength and other limitations. All other rated total loads are based on stability, not exceeding 75% of tipping loads.  
 6. Crane users must consult the Operator's Manual for complete details about assembly, operation, maintenance, configuration, and its limitations. Modifications to the crane, other than what is specified or supplied by the original equipment manufacturer can result in a reduction of rated total load ratings.  
 7. This operating range chart does not include boom deflections.  
 8. At certain working conditions, moment limiter may display bisser load value than actual load.  
 9. RESTRICTED AREA: At high boom angles, E-Boom (arm) and the hook will interfere with each other.  
 To avoid this interference: In SH1 position, do not operate above 30 degree boom angle.

## 2. SEARCHER HOOK EACH SECTION

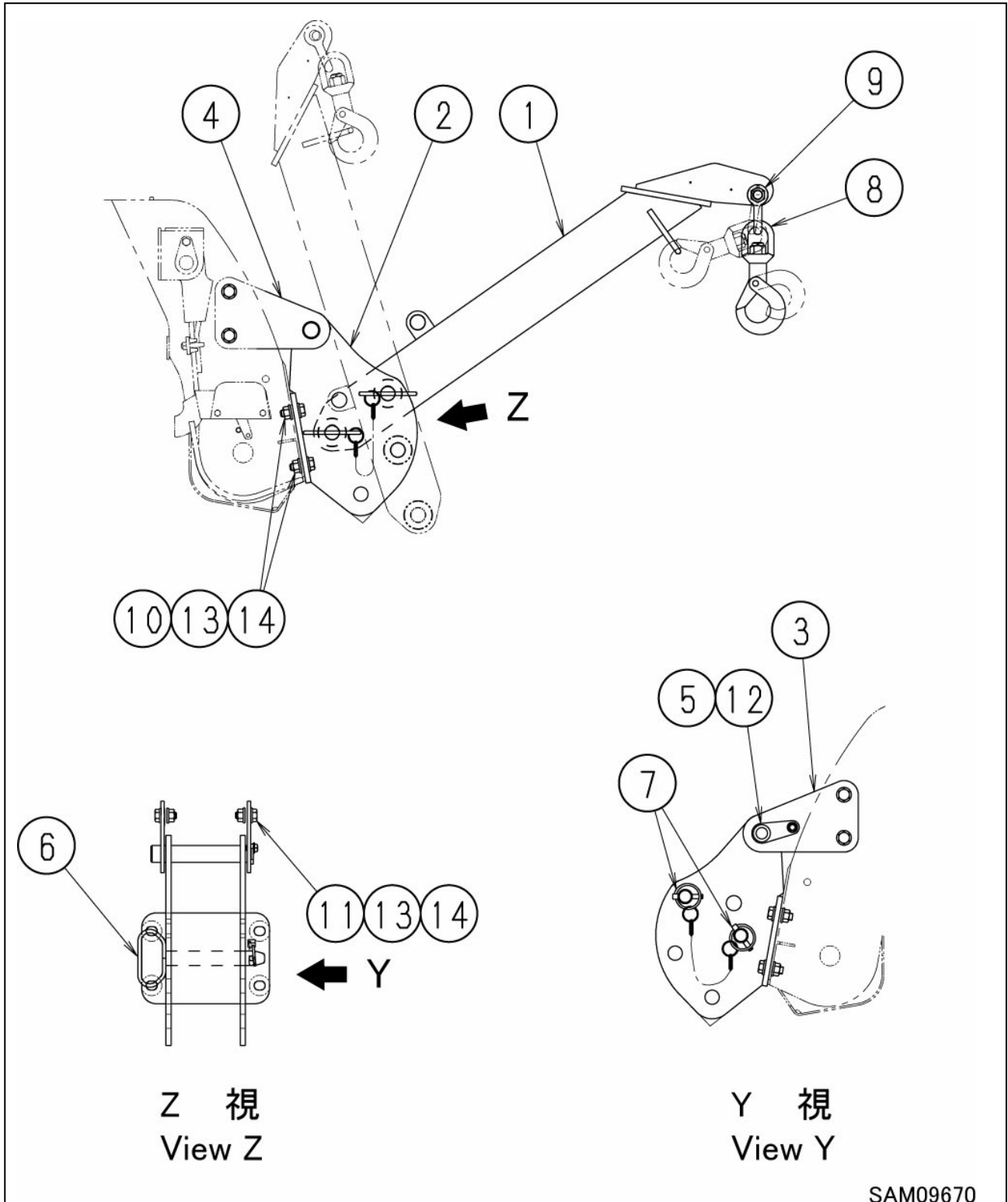

- (1) E-Boom
- (2) Bracket
- (3) Bracket 1
- (4) Bracket 2
- (5) Pin
- (6) Position pin
- (7) Linch pin

- (8) Hook
- (9) Shackle
- (10) Hexagonal bolt with washer (strength 10.9)
- (11) Hexagonal bolt with washer (strength 10.9)
- (12) Hexagonal bolt with washer (strength 10.9)
- (13) Nut (strength 10)
- (14) High tension washer

### 3. MOMENT LIMITER DISPLAY UNIT

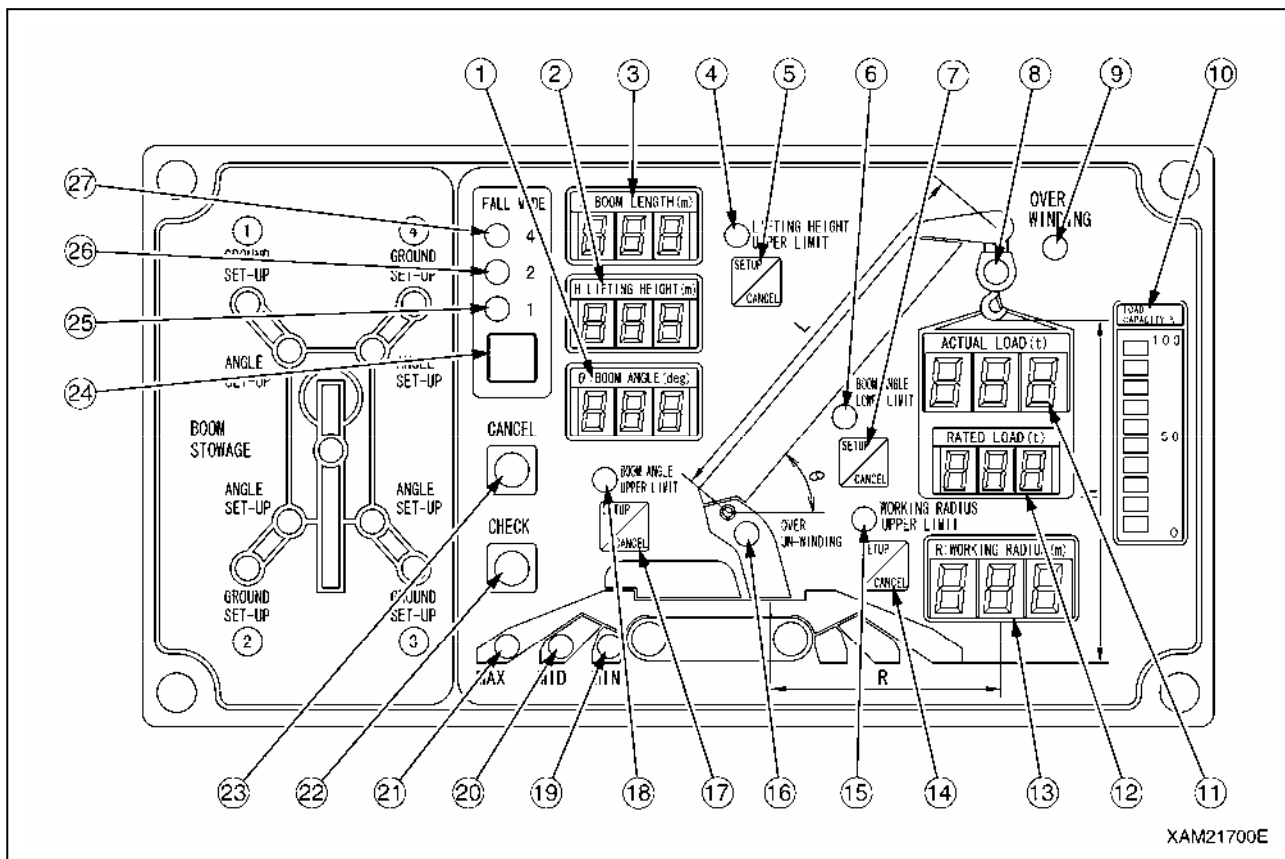

- |   |   |
|---|---|
| <ul style="list-style-type: none"> <li>(1) Boom angle display</li> <li>(2) Lifting height display</li> <li>(3) Boom length display</li> <li>(4) Boom lifting height upper limit LED (Orange)</li> <li>(5) Boom lifting height upper limit switch (Setup / cancel)</li> <li>(6) Boom angle lower limit LED (Orange)</li> <li>(7) Boom angle lower limit switch (setup / cancel)</li> <li>(8) Load factor LED (Changes to green, yellow, and red)</li> <li>(9) Over winding LED (Red)</li> <li>(10) Load capacity display (Yellow)</li> <li>(11) Actual load display</li> <li>(12) Rated total load display</li> <li>(13) Working radius display</li> </ul> | <ul style="list-style-type: none"> <li>(14) Working radius upper limit switch (Setup / cancel)</li> <li>(15) Working radius upper limit LED (Orange)</li> <li>(16) Over un-winding LED (Orange)</li> <li>(17) Boom angle upper limit switch (setup / cancel)</li> <li>(18) Boom angle upper limit LED (Orange)</li> <li>(19) Outrigger MIN. extension LED (Blue)</li> <li>(20) Outrigger MID. extension LED (Blue)</li> <li>(21) Outrigger MAX. extension LED (Blue)</li> <li>(22) Check switch</li> <li>(23) Cancel switch</li> <li>(24) Fall mode / Option selector switch</li> <li>(25) 1-fall LED (Blue)</li> <li>(26) 2-fall LED (Blue)</li> <li>(27) 4-fall LED (Blue)</li> </ul> |
|---|---|

### 3.1 DESCRIPTIONS OF SWITCHES MOMENT LIMITER DISPLAY UNIT

#### **⚠ CAUTION**

See “Operation 1.6 Moment Limiter” for how to operate the moment limiter.

#### 3.1.1 WIRE FALLS SELECTOR SWITCH AND WIRE FALLS DISPLAY LED (BLUE)

#### **⚠ DANGER**

Fall mode/option mode and searcher hook must be set as “850kg searcher hook mode”.

Using 850kg searcher hook other than in 850kg searcher hook mode may prevent activation of the pre-warnings and boom auto-stop even when approaching overload, and thus may result in crane damage or machine tipping that could cause a serious accident.

Use this switch to change the number of falls.

- Shift the fall mode/option selector switch (23) on moment limiter display unit to “850kg searcher hook mode” (**all LED flashes**). Each time you press the switch for 2 seconds or more, the setting of the fall mode changes in the order of “4 falls → 300kg searcher hook mode (all LED ON) → 850kg searcher hook (**all LED flashes**) → single fall → 2 falls → 4 falls ···”.

#### **NOTES**

When changing the setting, right after doing so, release your hand from the switch, and then press the switch again.

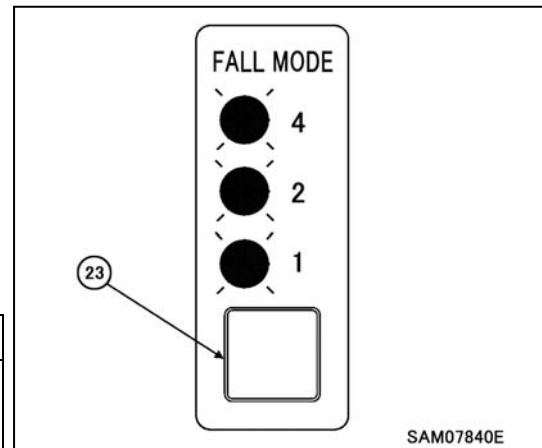

### 3.1.2 CANCEL SWITCH

## **⚠ DANGER**

Do not use 850kg searcher hook if actual searcher hook offset position and display of boom length window do not match. Without setting moment limiter to the actual searcher hook offset position, moment limiter may not work properly and thus may result in crane damage or machine tipping and could cause a serious accident.

Use this switch and fall mode/option selector switch to set searcher hook offset position shown in the boom length window.

- With fall mode set as 850kg searcher hook mode, press fall mode/option selector switch (23) and cancel switch (22) at the same time for 2 seconds or more and shift to set actual searcher hook offset position.

See “Searcher Hook offset position and boom length window display” on page 9-9 for correct setting.

Pressing fall mode/option selector switch (23) and cancel switch (22) at the same time for 2 seconds or more shifts boom length display in order of “SH1 → SH2 → SH3 → SH1 ...”

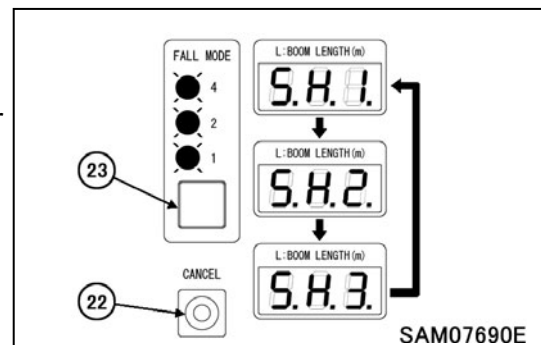

## **NOTES**

When changing the setting, right after doing so, release your hand from the switch, and then press the switch again.

When in 850kg searcher hook mode, searcher hook position mode display and actual boom length value are shown alternately.

Searcher Hook offset position and mode display in boom length window

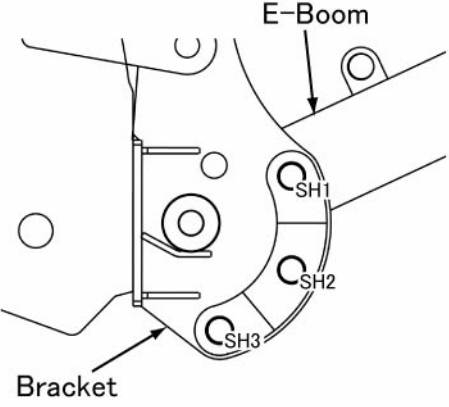
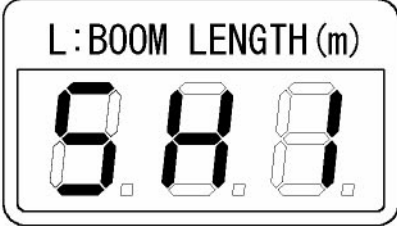
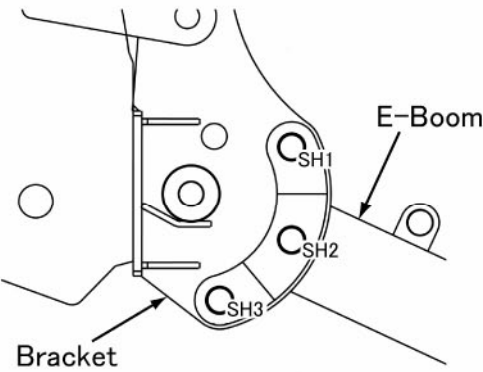
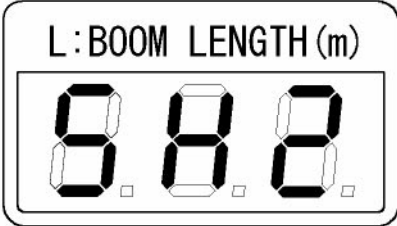
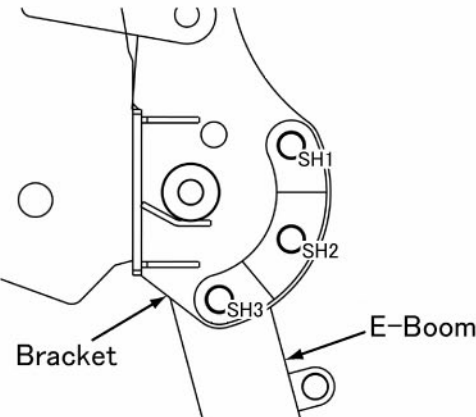
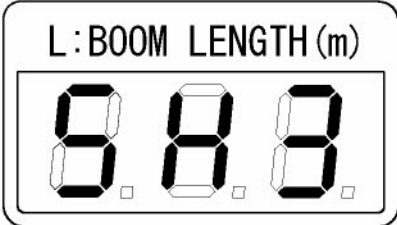
| SEARCHER HOOK POSITION  | MOMENT LIMITER BOOM LENGTH   |
|---|--|
|  <p>When a E-Boom is set SH1</p>   |    |
|  <p>When a E-Boom is set SH2</p>  |   |
|  <p>When a E-Boom is set SH3</p> |  |

SAM10700

## 4. OPERATION

1. See "Operation 2.14 Outrigger Setting" and set the outrigger

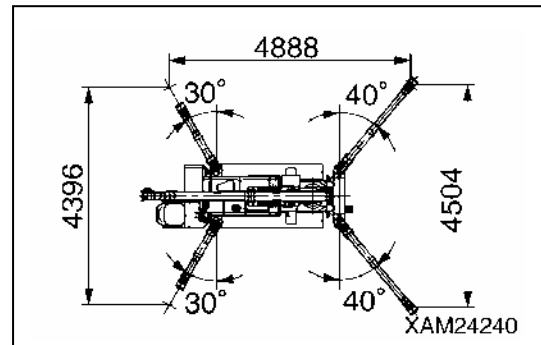

2. Install bracket (1), (2), and (3) using M12 bolts with washers (strength 10.9), nuts, and washers to main boom.  
Using torque wrench, tighten bolts at  $93\text{N}\cdot\text{m}$  ( $\pm 14\text{N}\cdot\text{m}$ ).  
Then insert pin (4) into holes of bracket (1), (2), and (3) as shown in the drawing, and tighten M8 bolts with washers (strength 10.9) at torque  $27\text{N}\cdot\text{m}$  ( $\pm 8\text{N}\cdot\text{m}$ ).

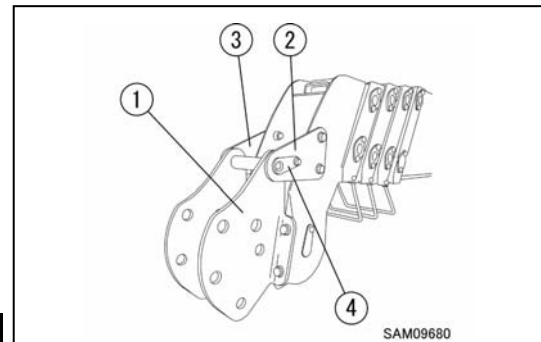

### **⚠ DANGER**

**Crash Hazard. Make sure to torque searcher hook mounting plate bolts to the designated tightening torque. To install searcher hook, always use new genuine Maeda bolts, nuts, and washers.**

3. Using fall mode/option selector switch (23), set moment limiter to 850kg searcher hook mode (all LED flashes).  
Also make sure the boom length display changes to either SH1, SH2, or SH3.

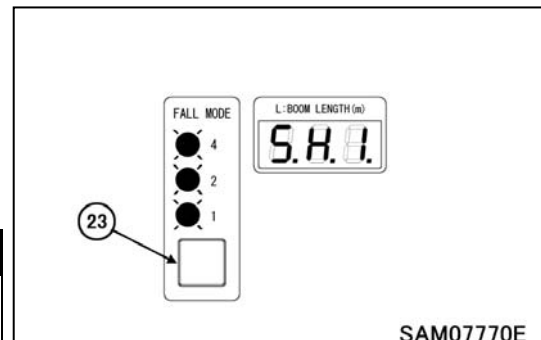

### **⚠ DANGER**

**Do not operate 850kg searcher hook without setting moment limiter as "850kg searcher hook mode". Without setting in correct mode, moment limiter will not work properly, and thus may result in crane damage or a serious accident.**

### **⚠ CAUTION**

**The last status of fall mode/option mode is memorized even after starter switch is turned to the OFF position**

- Remove the Linch pin (6) from the end of position pin (5), and remove the position pin (5).

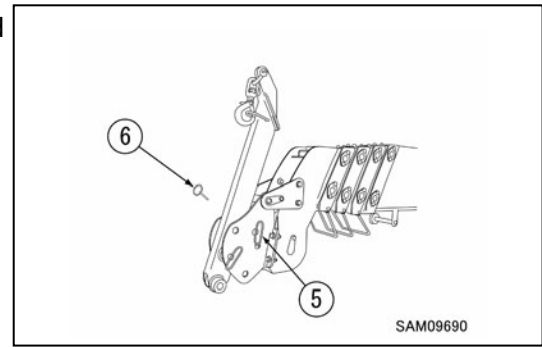

- Line up the hole (8) in E-boom (7) tip and hole (9) in bracket.

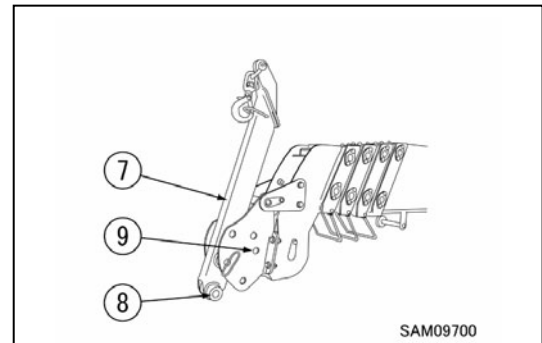

- Insert the removed position pin (5) (in procedure 4.) through the hole of bracket (9), and secure with lynch pin (6) to the tip of position pin (5).

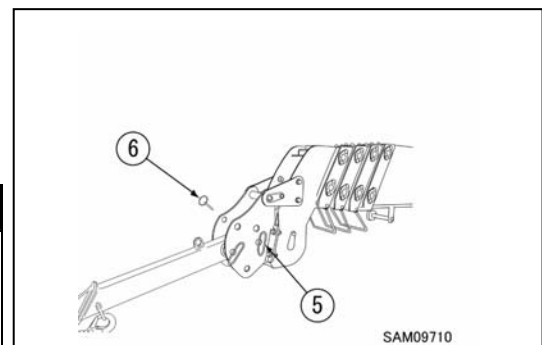

**⚠ DANGER**

Always secure the position pin (5) with the lynch pin (6). If the position pin falls out during operations, serious injury or damage to the machine may result.

- Remove lynch pin (11) from the tip of position pin (10), and remove the position pin (10).

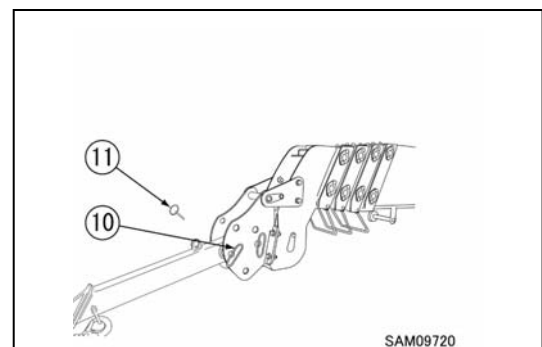

- Move E-boom (7) to the required angle for the work, and line the holes (1) in the E-boom (7).

**⚠ DANGER**

E-boom and hook may interfere with each other in RESTRICTED AREA on Rated Total Load chart, and it may cause a serious accident. Always adjust boom angle to proper position for the work.

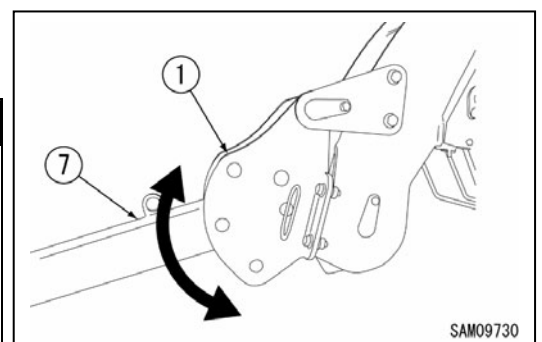



9. Insert the position pin (10) through the hole of bracket, and secure with lynch pin (11) to the tip of position pin (10).

**⚠ DANGER**

**Always secure the position pin (10) with the lynch pin (11). If the position pin falls out during operations, serious injury or damage to the machine may result.**

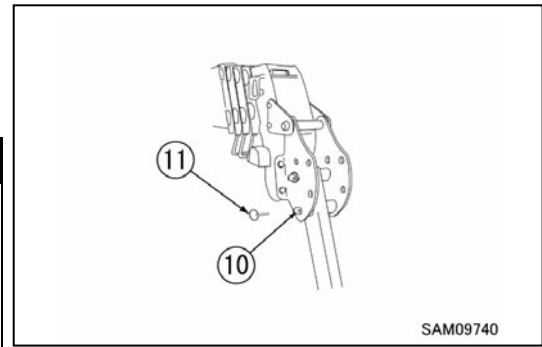

10. With fall mode set as 850kg searcher hook mode, press fall mode/option selector switch (23) and cancel switch (22) at the same time for 2 seconds or more and shift to set actual searcher hook offset position.

See “Searcher Hook offset position and boom length window display” on page 9-9 for correct setting.

Pressing fall mode/option selector switch (23) and cancel switch (22) at the same time for 2 seconds or more shifts boom length display in order of “SH1 → SH2 → SH3 → SH1 ...”

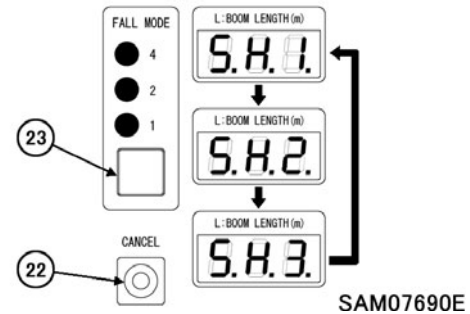

**⚠ DANGER**

**Do not use 850kg searcher hook if actual searcher hook offset position and display of boom length window do not match. Without setting moment limiter to the actual searcher hook offset position, moment limiter may not work properly and thus may result in crane damage or machine tipping and could cause a serious accident.**

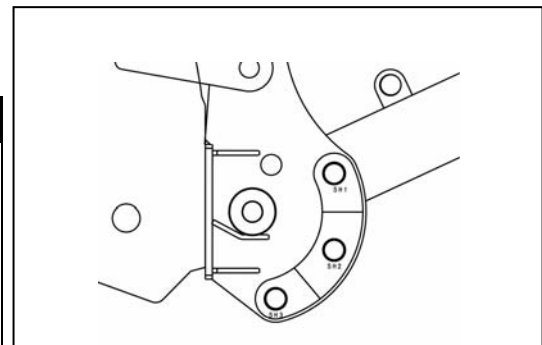

11. Attach the load securely to the hook (12) and start operations.

**⚠ DANGER**

**When hoisting a load in 850kg searcher hook mode, raise boom to hoist the load off the ground, and stop for a while to check if the load is safe to hoist.**

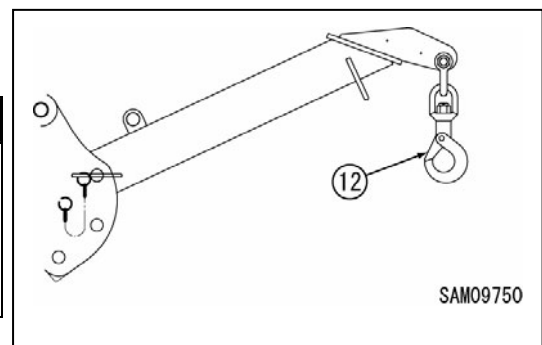

**NOTES**

- Characteristic of moment limiter display
    - At certain working conditions, moment limiter may display bigger load value than actual load.
    - Sudden lever operation increases error in reading load.
- When operating boom derricking lever, move the lever slowly.

12. When operation is auto-stopped by reaching overload during boom lowering or extending operation, first retract boom to recover into safe load range, and then lower boom to ground the load.

If boom lift must be operated due to the situation, use boom lift bypass switch (11) to enable the boom lift function.

To operate boom lifting using this boom lift bypass switch (13), keep pressing the switch to upper side and operate boom lift at the same time.

After the work, release the switch and it automatically turns off.

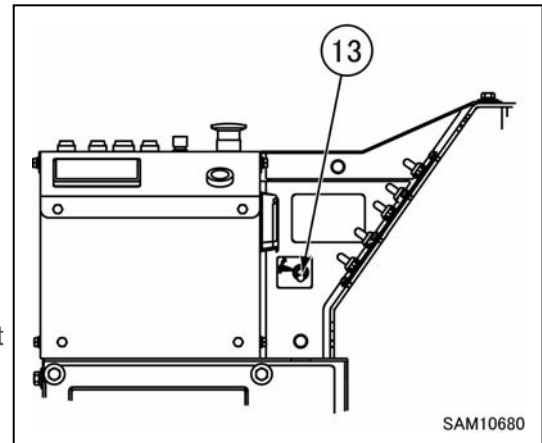

**⚠ DANGER**

**The boom lift bypass switch is to be used only when in searcher hook mode.**

**The boom lift function is stopped automatically when overloaded.**

**Never use this for normal lifting of loads clear of ground.**

**Hoisting a load off ground by using this switch may cause damage to the machine and serious accident.**

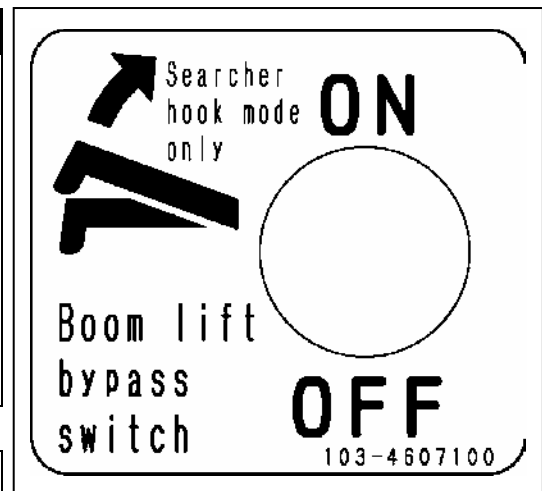

**NOTES**

In case machine is automatically stopped by entering overload area by boom lowering or boom extending operation, recover from the overload area by retracting boom, or lifting boom by keeping the boom lift bypass switch to ON side.

**NOTES**

When working envelope is set, and operation automatically stops at the boom upper angle limit or hook height upper limit, boom can be lifted beyond the limit by using this boom lift bypass switch. The boom lift bypass switch is to be used only when in searcher hook mode.

**[Caution]**

E-boom and hook may interfere with each other in RESTRICTED AREA on Rated Total Load chart.

Do not exceed 30 degrees of boom angle when E-boom offset position is in SH1.

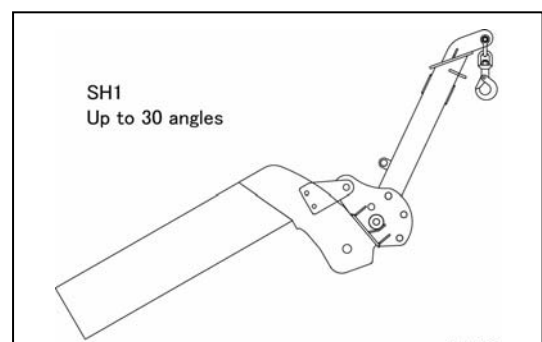

## 5. INSPECTION AND MAINTENANCE

### 5.1 LEGAL INSPECTION

If a periodic safety inspection is required by the laws and regulations of your country, perform that inspection in addition to the inspection items listed below.

1. Verify that all safety devices are operating properly.
2. Check the hoist accessories, including the hook block, for problems or damage.
3. Check the structural parts of the machine, including the frame and boom, for cracks, deformation and damage.
4. Check for loose or missing mounting bolts and joints.
5. Verify that the boom operates properly by stopping, extending, retracting, raising, lowering and swinging the boom.

Contact Maeda or a Maeda sales service agency to request inspection and repair service as needed.

### 5.2 CONSUMABLES

Parts for mounting searcher hook are consumable items. Replace them at periodic inspection or before they reach abrasion limits. Replace consumable items regularly, which will produce economical use of this machine. Always replace with a Maeda genuine item. Check parts catalog for correct part number for parts request.

#### [CONSUMABLES LIST]

| Part  | Replacement cycle  |
|---|--|
| Searcher hook fix bolt<br>M12x35L strength 10.9 (4pcs)    | Every 6 months or when damage, crack, or squash is found |
| Searcher hook fix bolt<br>M12x30L strength 10.9 (4pcs)    | Every 6 months or when damage, crack, or squash is found |
| Searcher hook fix bolt<br>M8x16L strength 10.9 (1pcs)     | Every 6 months or when damage, crack, or squash is found |
| Searcher hook fix nut<br>M12x1grade (8pcs)                | Every 6 months or when damage, crack, or squash is found |
| Searcher hook fix washer<br>M12x3.2t (high tension)(8pcs) | Every 6 months or when damage, crack, or squash is found |

Items include a halt period. Contact Maeda or a Maeda sales service agency for part replacement information.

## 5.3 INSPECTION AND MAINTENANCE LIST

This document only covers 850kg searcher hook kit. For crane body, please refer to “Inspection and Maintenance” and follow its precautions.

| Inspection and maintenance items                                    | Page |
|---|------|
| 5.4.1 INSPECTION BEFORE OPERATION                                   | 9-16 |
| [CHECKING BEFORE STARTING ENGINE]                                   | 9-16 |
| [1]CHECKING E-BOOM, FRAME AND HOOK                                  | 9-16 |
| [2]GREASING   | 9-16 |
| [3]CHECKING SEARCHER HOOK FIX BOLTS                                 | 9-16 |
| [4]INSTALLATION CHECK OF POSITION PIN AND LYNCH PIN                 | 9-16 |
| [CHECKING AFTER STARTING ENGINE]                                    | 9-17 |
| [1]CHECKING MOMENT LIMITER FOR OPERATION (850kg SEARCHER HOOK MODE) | 9-17 |

## 5.4 MAINTENANCE PROCEDURES

### 5.4.1 INSPECTION BEFORE OPERATION

#### [CHECKING BEFORE STARTING ENGINE]

Check the following in this section without starting the engine and before starting work every day.

#### [1] CHECKING E-BOOM, FRAME AND HOOK

Check each part of the E-Boom, frame and Hook for cracks, excessive deformation and contamination etc. In addition, check bolts nuts and pins for any looseness, drop and damage etc. If you find any abnormality, repair.

Check hook for deformation, abnormal noise from bearing and correct function of wire rope latch (1).

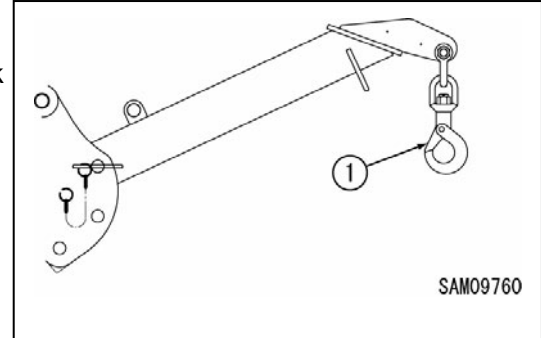

#### [2] GREASING

Wipe off and clean old grease from contact point (3) of shackle (2) and E-boom hole, and contact point (4) of hook (1) and shackle (2), then apply new lithium grease.

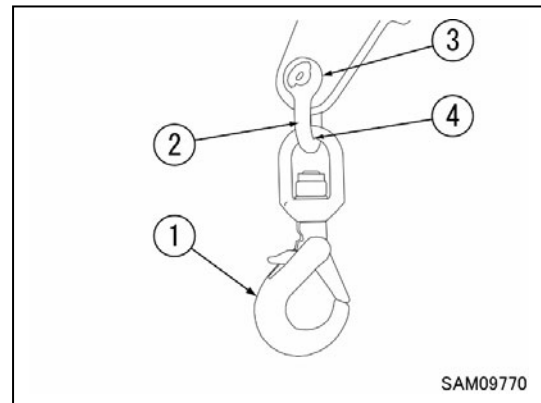

#### [3] CHECKING SEARCHER HOOK FIX BOLTS

### **⚠ DANGER**

**If any damage is found on searcher hook fixing bolts, please exchange for new one's right away.  
Breakage of bolts will cause the searcher hook to fall off.**

Check if bolts used are the designated type.

Also check if there are cracks, damage, squashing, heavy dirt, or rust on bolt.

If any abnormality is found, change the bolt for a new one even it is earlier than expected bolt life.

#### [4] INSTALLATION CHECK OF POSITION PIN AND LYNCH PIN

Check if position pin is surely secured with lynch pin.

## [CHECKING AFTER STARTING ENGINE]

### CAUTION

The checkups described in this section should be carried out after starting the machine.  
See "Operation 2.2 Starting the Engine" and later to execute the engine startup, travelling operations, outrigger operations and crane operations.

## [1] CHECKING MOMENT LIMITER FOR OPERATION (850kg SEARCHER HOOK MODE)

### WARNING

If you find any abnormality with the moment limiter, immediately contact us or our sales service agency.

1. Turn the starter switch to the "ON" position.
2. Check with the working status lamp. The red of the lamp lights up for 2 seconds and then the green lights up.
3. Check the moment limiter display unit.  
Verify that no error code is displayed at the "RATED TOTAL LOAD" display on the display panel.  
Check if moment limiter is set as 850kg searcher hook mode, and display in boom length window matches actual searcher hook offset position.  
See "Searcher Hook offset position and boom length window display" on page 9-9 for correct setting.
4. Shift the part of line selector switch on moment limiter display unit to "850kg Searcher hook mode".
5. Start the engine and operate the crane as follows to verify if the moment limiter properly displays the value.

| Crane Operation and Displayed Parameter   | Value Displayed on Moment Limiter |
|---|-----------------------------------|
| Displayed "boom length" with the boom length at minimum                             | 3.7 m                             |
| Displayed "boom length" with the boom length at maximum                             | 12.5 m                            |
| Displayed "working radius" with the boom length of "5.9 m" and boom angle of "25 °" | SH1 5.7 ± 0.1 m                   |
|   | SH2 6.1 ± 0.1 m                   |
|   | SH3 5.8 ± 0.1 m                   |

6. Check if displayed actual load value is equal to the total weight of the load + the hoisting accessory, when the weight of the known load is hoisted. There may be slight error in accuracy depending on boom condition.
7. Operate the crane until the moment limiter display indicates the boom length is "5.9 m" and boom angle is "25 degrees", then measure the "boom angle" and "working radius".  
If the measured value(s) differ from the moment limiter display value, contact MAEDA or MAEDA sales agency.
8. Lift up load and check if boom extending or boom lowering operation is auto-stopped when overloaded. If the operation is not auto-stopped in overloaded condition, please contact us or our sales service agency and do not use the machine.  
This checking operation must be operated slowly, and if machine does not auto-stop by overloading, immediately stop the operation, and perform recovery operation caused by overloading.

### NOTES

When measuring actual working radius, measure from hook offset position of searcher hook.

## 6. WORKING RANGE AND RATED TOTAL LOAD

### ⚠ DANGER

- When using the searcher hook, be sure to set searcher hook mode for moment limiter.
- Fall mode/option mode and searcher hook position must be set as “850kg searcher hook mode” when 850kg searcher hook is used. Searcher hook position must be displayed on moment limiter boom length window.
- Never use the searcher hook and the crane hook simultaneously.

### 6.1 WORKING RANGE DIAGRAM FOR SEARCHER HOOK

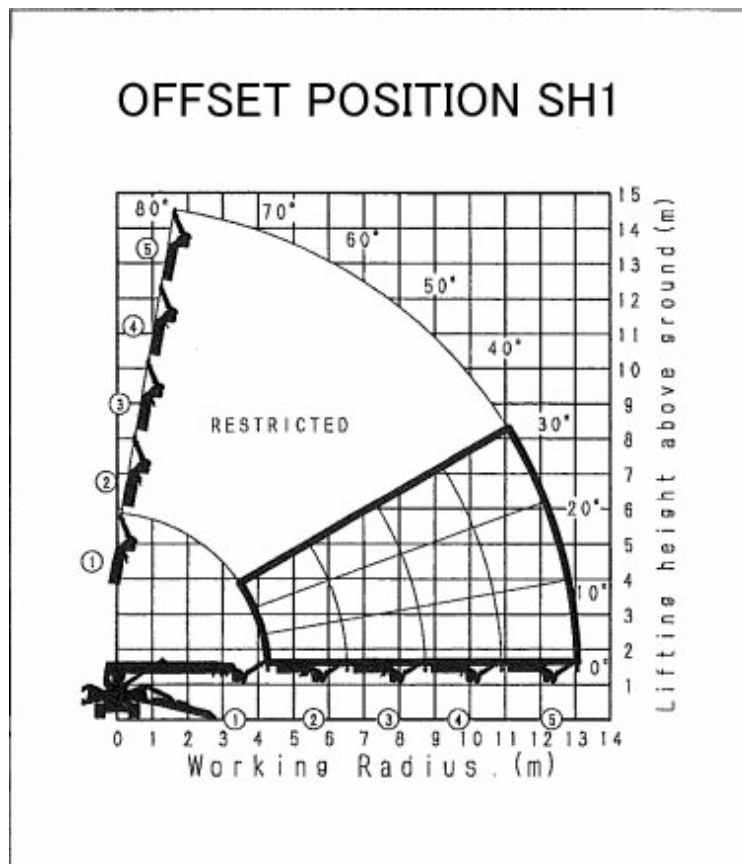

## OFFSET POSITION SH2

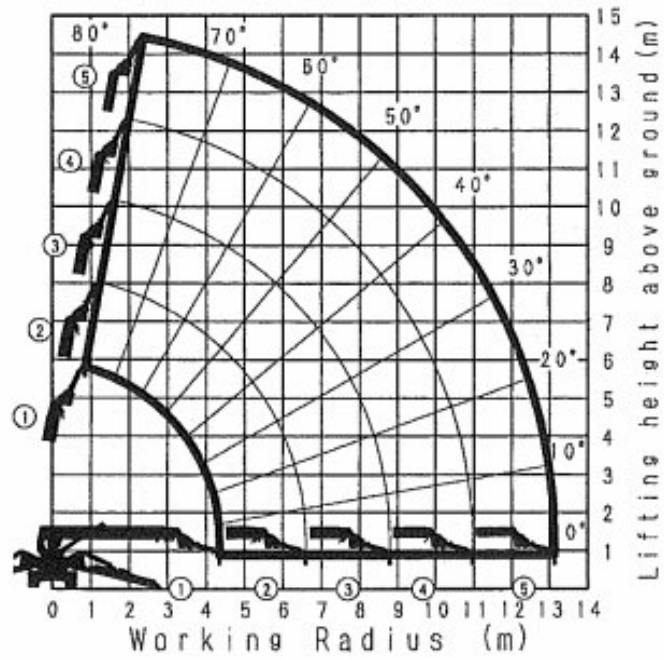

## OFFSET POSITION SH3

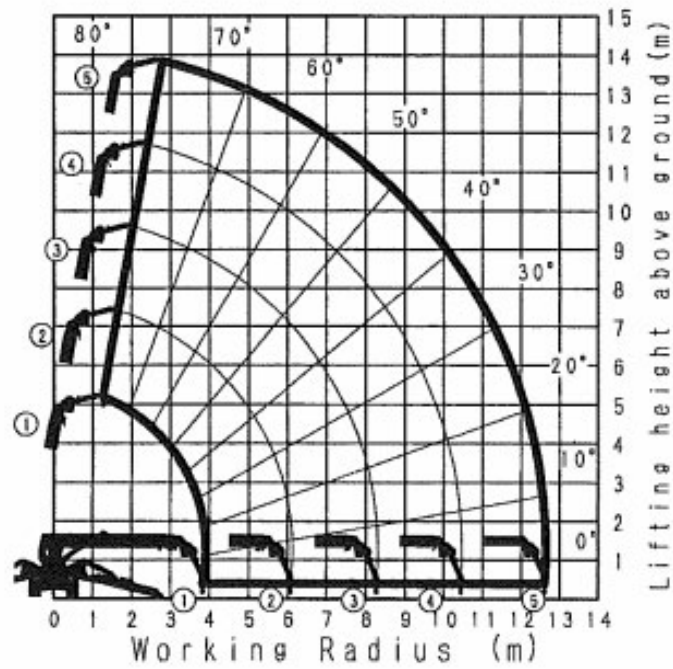





## 6.2 RATED TOTAL LOAD CHART FOR SEARCHER HOOK

1. This Rated Total Load Chart shows the maximum allowable capacities. These rated total loads are based on the machine standing level on a firm ground supporting surface, under ideal job conditions and a freely suspended load.
2. Sufficient design tolerance must be used to ensure adequate ground support surface design. The rated total loads are for static conditions only, and do not include dynamic effects of slewing, extending, retracting, lowering, raising, wind or adverse conditions. Crane users must reduce rated total loads ratings to take all conditions into account.
3. The Working radius shown in the Rated Total Load Chart is based on practical working radius including boom deflection due to loading. The crane user must calculate and compensate for boom deflection as the load is lifted.
4. Deductions from Searcher Hook Rated Total Load must be made for the weight of the 850kg searcher hook (20kg), block/ball and all rigging.
5. If boom (3) is extended to any extent, work should be performed within the capacity for “8.145m Boom”.
6. If boom (4) is extended to any extent, work should be performed within the capacity for “10.315m Boom”.
7. When more than one half of the third  mark is exposed from the boom (3), work should be carried out within the performance for the “12.485m Boom”.
8. All capacities above the bold line are based on structural strength and other limitations. All other rated total loads are based on stability not exceeding 75% of tipping loads.
9. Crane users must consult the Operators Manual for complete details about assembly, operation, maintenance, configuration, and its limitations. Modifications to the crane, other than what is specified or supplied by the original equipment manufacture, can result in a reduction of rated total load ratings.
10. This operating range chart does not include boom deflections.
11. At certain working conditions, moment limiter may display bigger load value the actual load.
12. RESTRICTED AREA : At high boom angles, E-Boom (arm) and the hook will interfere with each other. To avoid this interference : In SH1 position, do not operate above 30 degree boom angle.

OFFSET POSITION SH1

| Working Radius (m) | ① 3.695m BOOM           |                    |     |     | ② 5.945m BOOM |   |                    |     | ③ 8.145m BOOM |     |   |                    | ④ 10.315m BOOM |     |     |  | ⑤ 12.485m BOOM     |     |     |     | Working Radius (m) |  |                    |     |              |     |     |     |              |     |     |     |              |     |     |      |     |
|--------------------|-------------------------|--------------------|-----|-----|---------------|---|--------------------|-----|---------------|-----|---|--------------------|----------------|-----|-----|--|--------------------|-----|-----|-----|--------------------|--|--------------------|-----|--------------|-----|-----|-----|--------------|-----|-----|-----|--------------|-----|-----|------|-----|
|                    | BOOM FULLY RETRACTED    |                    |     |     |               | WHEN BOOM 2 IS EXTENDED TO ANY EXTENT, USE RATINGS FOR 3.696m-5.945m BOOM |                    |     |               |     | WHEN BOOM 3 IS EXTENDED TO ANY EXTENT, USE RATINGS FOR 5.946m-8.145m BOOM |                    |                |     |     | WHEN BOOM 4 IS EXTENDED TO ANY EXTENT, USE RATINGS FOR 8.146m-10.315m BOOM |                    |     |     |     |                    | WHEN THE MARK  ON BOOM 4 IS EXPOSED, USE RATINGS FOR 10.316m-12.485m BOOM |                    |     |              |     |     |     |              |     |     |     |              |     |     |      |     |
|                    | LOADED BOOM ANGLE (deg) | OUTRIGGER POSITION |     |     |               | LOADED BOOM ANGLE (deg)   | OUTRIGGER POSITION |     |               |     | LOADED BOOM ANGLE (deg)   | OUTRIGGER POSITION |                |     |     | LOADED BOOM ANGLE (deg)  | OUTRIGGER POSITION |     |     |     |                    | LOADED BOOM ANGLE (deg)  | OUTRIGGER POSITION |     |              |     |     |     |              |     |     |     |              |     |     |      |     |
| MAX                |                         | MID                | MIN | MIN | MAX           |   | MID                | MIN | MIN           | MAX |   | MID                | MIN            | MIN | MAX |  | MID                | MIN | MIN | MAX | MID                |  | MIN                | MIN |              |     |     |     |              |     |     |     |              |     |     |      |     |
| 3.5                | 30.0 OR MORE            | RESTRICTED         |     |     |               | 30.0 OR MORE  | RESTRICTED         |     |               |     | 30.0 OR MORE  | RESTRICTED         |                |     |     | 30.0 OR MORE   | RESTRICTED         |     |     |     | 30.0 OR MORE       | RESTRICTED   |                    |     |              | 3.5 |     |     |              |     |     |     |              |     |     |      |     |
| 4.3                | 29.5                    | 850                | 850 | 850 | 0.0           | 850   | 850                | 850 | 29.0          | 850 | 850   | 850                | 21.0           | 660 | 560 | 460  | 21.0               | 590 | 470 | 380 | 3.0                | 530  | 430                | 350 | 29.5         | 240 | 220 | 210 | 21.5         | 220 | 200 | 180 | 0.0          | 210 | 200 | 160  | 4.3 |
| 4.3                | 0.0                     | 850                | 850 | 850 | 30.0 OR MORE  | 850   | 850                | 850 | 3.0           | 850 | 740   | 610                | 30.0 OR MORE   | 850 | 850 | 850  | 30.0 OR MORE       | 850 | 850 | 850 | 30.0 OR MORE       | 850  | 850                | 850 | 30.0 OR MORE | 850 | 850 | 850 | 30.0 OR MORE | 850 | 850 | 850 | 30.0 OR MORE | 850 | 850 | 850  | 4.3 |
| 5.5                |                         |                    |     |     |               |   |                    |     |               |     |   |                    |                |     |     |  |                    |     |     |     |                    |  |                    |     |              |     |     |     |              |     |     |     |              |     |     | 5.5  |     |
| 6.5                |                         |                    |     |     |               |   |                    |     |               |     |   |                    |                |     |     |  |                    |     |     |     |                    |  |                    |     |              |     |     |     |              |     |     |     |              |     |     | 6.5  |     |
| 7.4                |                         |                    |     |     |               |   |                    |     |               |     |   |                    |                |     |     |  |                    |     |     |     |                    |  |                    |     |              |     |     |     |              |     |     |     |              |     |     | 7.4  |     |
| 8.0                |                         |                    |     |     |               |   |                    |     |               |     |   |                    |                |     |     |  |                    |     |     |     |                    |  |                    |     |              |     |     |     |              |     |     |     |              |     |     | 8.0  |     |
| 8.7                |                         |                    |     |     |               |   |                    |     |               |     |   |                    |                |     |     |  |                    |     |     |     |                    |  |                    |     |              |     |     |     |              |     |     |     |              |     |     | 8.7  |     |
| 9.3                |                         |                    |     |     |               |   |                    |     |               |     |   |                    |                |     |     |  |                    |     |     |     |                    |  |                    |     |              |     |     |     |              |     |     |     |              |     |     | 9.3  |     |
| 10.5               |                         |                    |     |     |               |   |                    |     |               |     |   |                    |                |     |     |  |                    |     |     |     |                    |  |                    |     |              |     |     |     |              |     |     |     |              |     |     | 10.5 |     |
| 10.9               |                         |                    |     |     |               |   |                    |     |               |     |   |                    |                |     |     |  |                    |     |     |     |                    |  |                    |     |              |     |     |     |              |     |     |     |              |     |     | 10.9 |     |
| 11.2               |                         |                    |     |     |               |   |                    |     |               |     |   |                    |                |     |     |  |                    |     |     |     |                    |  |                    |     |              |     |     |     |              |     |     |     |              |     |     | 11.2 |     |
| 12.0               |                         |                    |     |     |               |   |                    |     |               |     |   |                    |                |     |     |  |                    |     |     |     |                    |  |                    |     |              |     |     |     |              |     |     |     |              |     |     | 12.0 |     |
| 13.1               |                         |                    |     |     |               |   |                    |     |               |     |   |                    |                |     |     |  |                    |     |     |     |                    |  |                    |     |              |     |     |     |              |     |     |     |              |     |     | 13.1 |     |

OFFSET POSITION SH2

| Working Radius (m) | ① 3.695m BOOM           |                    |     |     | ② 5.945m BOOM |   |                    |     | ③ 8.145m BOOM |     |   |                    | ④ 10.315m BOOM |     |     |  | ⑤ 12.485m BOOM     |     |     |     | Working Radius (m) |  |                    |     |     |     |     |     |  |  |  |  |  |  |  |     |      |
|--------------------|-------------------------|--------------------|-----|-----|---------------|---|--------------------|-----|---------------|-----|---|--------------------|----------------|-----|-----|--|--------------------|-----|-----|-----|--------------------|--|--------------------|-----|-----|-----|-----|-----|--|--|--|--|--|--|--|-----|------|
|                    | BOOM FULLY RETRACTED    |                    |     |     |               | WHEN BOOM 2 IS EXTENDED TO ANY EXTENT, USE RATINGS FOR 3.696m-5.945m BOOM |                    |     |               |     | WHEN BOOM 3 IS EXTENDED TO ANY EXTENT, USE RATINGS FOR 5.946m-8.145m BOOM |                    |                |     |     | WHEN BOOM 4 IS EXTENDED TO ANY EXTENT, USE RATINGS FOR 8.146m-10.315m BOOM |                    |     |     |     |                    | WHEN THE MARK  ON BOOM 4 IS EXPOSED, USE RATINGS FOR 10.316m-12.485m BOOM |                    |     |     |     |     |     |  |  |  |  |  |  |  |     |      |
|                    | LOADED BOOM ANGLE (deg) | OUTRIGGER POSITION |     |     |               | LOADED BOOM ANGLE (deg)   | OUTRIGGER POSITION |     |               |     | LOADED BOOM ANGLE (deg)   | OUTRIGGER POSITION |                |     |     | LOADED BOOM ANGLE (deg)  | OUTRIGGER POSITION |     |     |     |                    | LOADED BOOM ANGLE (deg)  | OUTRIGGER POSITION |     |     |     |     |     |  |  |  |  |  |  |  |     |      |
| MAX                |                         | MID                | MIN | MIN | MAX           |   | MID                | MIN | MIN           | MAX |   | MID                | MIN            | MIN | MAX |  | MID                | MIN | MIN | MAX | MID                |  | MIN                | MIN | MAX | MID | MIN | MIN |  |  |  |  |  |  |  |     |      |
| 2.7                | 54.5                    | 850                | 850 | 850 | 67.5          | 850   | 850                | 850 | 73.0          | 850 | 850   | 850                | 76.5           | 850 | 850 | 850  |                    |     |     |     |                    |  |                    |     |     |     |     |     |  |  |  |  |  |  |  | 2.7 |      |
| 4.0                | 27.0                    | 850                | 850 | 850 | 54.5          | 850   | 850                | 850 | 64.0          | 850 | 850   | 850                | 68.0           | 850 | 850 | 850  |                    |     |     |     |                    |  |                    |     |     |     |     |     |  |  |  |  |  |  |  | 4.0 |      |
| 4.3                | 13.0                    | 850                | 850 | 850 | 51.5          | 850   | 850                | 850 | 63.0          | 850 | 850   | 850                | 66.5           | 850 | 850 | 850  |                    |     |     |     |                    |  |                    |     |     |     |     |     |  |  |  |  |  |  |  | 4.3 |      |
| 4.5                |                         |                    |     |     | 49.0          | 850   | 850                | 850 | 60.5          | 850 | 850   | 850                | 64.0           | 850 | 850 | 850  |                    |     |     |     |                    |  |                    |     |     |     |     |     |  |  |  |  |  |  |  |     | 4.5  |
| 5.0                |                         |                    |     |     | 43.0          | 850   | 850                | 850 | 56.5          | 850 | 850   | 850                | 64.0           | 850 | 830 | 830  |                    |     |     |     |                    |  |                    |     |     |     |     |     |  |  |  |  |  |  |  | 5.0 |      |
| 6.0                |                         |                    |     |     | 27.0          | 850   | 850                | 740 | 48.5          | 850 | 820   | 680                | 58.0           | 710 | 700 | 660  |                    |     |     |     |                    |  |                    |     |     |     |     |     |  |  |  |  |  |  |  | 6.0 |      |
| 6.6                |                         |                    |     |     | 0.0           | 850   | 710                | 580 | 43.0          | 770 | 680   | 570                | 54.0           | 660 | 650 | 570  |                    |     |     |     |                    |  |                    |     |     |     |     |     |  |  |  |  |  |  |  | 6.6 |      |
| 7.0                |                         |                    |     |     |               |   |                    |     | 39.0          | 720 | 620   | 520                | 51.5           | 630 | 600 | 520  |                    |     |     |     |                    |  |                    |     |     |     |     |     |  |  |  |  |  |  |  |     | 7.0  |
| 8.0                |                         |                    |     |     |               |   |                    |     | 26.5          | 590 | 470   | 380                | 44.5           | 550 | 490 | 410  |                    |     |     |     |                    |  |                    |     |     |     |     |     |  |  |  |  |  |  |  |     | 8.0  |
| 8.8                |                         |                    |     |     |               |   |                    |     | 0.0           | 520 | 420   | 340                | 38.0           | 480 | 410 | 340  |                    |     |     |     |                    |  |                    |     |     |     |     |     |  |  |  |  |  |  |  |     | 8.8  |
| 10.0               |                         |                    |     |     |               |   |                    |     |               |     |   |                    | 26.0           | 410 | 330 | 270  |                    |     |     |     |                    |  |                    |     |     |     |     |     |  |  |  |  |  |  |  |     | 10.0 |
| 11.0               |                         |                    |     |     |               |   |                    |     |               |     |   |                    | 8.0            | 360 | 280 | 240  |                    |     |     |     |                    |  |                    |     |     |     |     |     |  |  |  |  |  |  |  |     | 11.0 |
| 12.0               |                         |                    |     |     |               |   |                    |     |               |     |   |                    |                |     |     |  |                    |     |     |     |                    |  |                    |     |     |     |     |     |  |  |  |  |  |  |  |     | 12.0 |
| 13.1               |                         |                    |     |     |               |   |                    |     |               |     |   |                    |                |     |     |  |                    |     |     |     |                    |  |                    |     |     |     |     |     |  |  |  |  |  |  |  |     | 13.1 |

OFFSET POSITION SH3

| Working Radius (m) | ① 3.695m BOOM           |                    |     |     | ② 5.945m BOOM |   |                    |     | ③ 8.145m BOOM |     |   |                    | ④ 10.315m BOOM |     |     |  | ⑤ 12.485m BOOM     |     |     |     | Working Radius (m) |  |                    |     |     |     |     |     |  |  |  |  |  |  |  |  |      |      |
|--------------------|-------------------------|--------------------|-----|-----|---------------|---|--------------------|-----|---------------|-----|---|--------------------|----------------|-----|-----|--|--------------------|-----|-----|-----|--------------------|--|--------------------|-----|-----|-----|-----|-----|--|--|--|--|--|--|--|--|------|------|
|                    | BOOM FULLY RETRACTED    |                    |     |     |               | WHEN BOOM 2 IS EXTENDED TO ANY EXTENT, USE RATINGS FOR 3.696m-5.945m BOOM |                    |     |               |     | WHEN BOOM 3 IS EXTENDED TO ANY EXTENT, USE RATINGS FOR 5.946m-8.145m BOOM |                    |                |     |     | WHEN BOOM 4 IS EXTENDED TO ANY EXTENT, USE RATINGS FOR 8.146m-10.315m BOOM |                    |     |     |     |                    | WHEN THE MARK  ON BOOM 4 IS EXPOSED, USE RATINGS FOR 10.316m-12.485m BOOM |                    |     |     |     |     |     |  |  |  |  |  |  |  |  |      |      |
|                    | LOADED BOOM ANGLE (deg) | OUTRIGGER POSITION |     |     |               | LOADED BOOM ANGLE (deg)   | OUTRIGGER POSITION |     |               |     | LOADED BOOM ANGLE (deg)   | OUTRIGGER POSITION |                |     |     | LOADED BOOM ANGLE (deg)  | OUTRIGGER POSITION |     |     |     |                    | LOADED BOOM ANGLE (deg)  | OUTRIGGER POSITION |     |     |     |     |     |  |  |  |  |  |  |  |  |      |      |
| MAX                |                         | MID                | MIN | MIN | MAX           |   | MID                | MIN | MIN           | MAX |   | MID                | MIN            | MIN | MAX |  | MID                | MIN | MIN | MAX | MID                |  | MIN                | MIN | MAX | MID | MIN | MIN |  |  |  |  |  |  |  |  |      |      |
| 2.5                | 60.0                    | 850                | 850 | 850 | 72.0          | 850   | 850                | 850 | 75.5          | 850 | 850   | 850                |                |     |     |  |                    |     |     |     |                    |  |                    |     |     |     |     |     |  |  |  |  |  |  |  |  | 2.5  |      |
| 2.7                | 56.5                    | 850                | 850 | 850 | 70.0          | 850   | 850                | 850 | 73.5          | 850 | 850   | 850                |                |     |     |  |                    |     |     |     |                    |  |                    |     |     |     |     |     |  |  |  |  |  |  |  |  | 2.7  |      |
| 3.0                | 50.5                    | 850                | 850 | 850 | 67.0          | 850   | 850                | 850 | 67.5          | 850 | 850   | 850                |                |     |     |  |                    |     |     |     |                    |  |                    |     |     |     |     |     |  |  |  |  |  |  |  |  | 3.0  |      |
| 3.8                | 25.0                    | 850                | 850 | 850 | 58.0          | 850   | 850                | 850 | 66.0          | 850 | 850   | 850                |                |     |     |  |                    |     |     |     |                    |  |                    |     |     |     |     |     |  |  |  |  |  |  |  |  |      | 3.8  |
| 4.0                |                         |                    |     |     | 56.0          | 850   | 850                | 850 | 62.0          | 850 | 850   | 850                |                |     |     |  |                    |     |     |     |                    |  |                    |     |     |     |     |     |  |  |  |  |  |  |  |  |      | 4.0  |
| 4.5                |                         |                    |     |     | 49.5          | 850   | 850                | 850 | 62.0          | 850 | 850   | 850                |                |     |     |  |                    |     |     |     |                    |  |                    |     |     |     |     |     |  |  |  |  |  |  |  |  |      | 4.5  |
| 5.0                |                         |                    |     |     | 42.5          | 850   | 850                | 850 | 58.0          | 850 | 850   | 850                |                |     |     |  |                    |     |     |     |                    |  |                    |     |     |     |     |     |  |  |  |  |  |  |  |  |      | 5.0  |
| 6.1                |                         |                    |     |     | 13.0          | 850   | 830                | 710 | 48.0          | 840 | 800   | 660                |                |     |     |  |                    |     |     |     |                    |  |                    |     |     |     |     |     |  |  |  |  |  |  |  |  | 6.1  |      |
| 7.0                |                         |                    |     |     |               |   |                    |     | 38.0          | 720 | 620   | 520                |                |     |     |  |                    |     |     |     |                    |  |                    |     |     |     |     |     |  |  |  |  |  |  |  |  |      | 7.0  |
| 8.3                |                         |                    |     |     |               |   |                    |     | 9.0           | 560 | 450   | 370                |                |     |     |  |                    |     |     |     |                    |  |                    |     |     |     |     |     |  |  |  |  |  |  |  |  |      | 8.3  |
| 9.0                |                         |                    |     |     |               |   |                    |     |               |     |   |                    |                |     |     |  |                    |     |     |     |                    |  |                    |     |     |     |     |     |  |  |  |  |  |  |  |  |      | 9.0  |
| 10.4               |                         |                    |     |     |               |   |                    |     |               |     |   |                    |                |     |     |  |                    |     |     |     |                    |  |                    |     |     |     |     |     |  |  |  |  |  |  |  |  |      | 10.4 |
| 11.0               |                         |                    |     |     |               |   |                    |     |               |     |   |                    |                |     |     |  |                    |     |     |     |                    |  |                    |     |     |     |     |     |  |  |  |  |  |  |  |  | 11.0 |      |
| 12.6               |                         |                    |     |     |               |   |                    |     |               |     |   |                    |                |     |     |  |                    |     |     |     |                    |  |                    |     |     |     |     |     |  |  |  |  |  |  |  |  |      | 12.6 |



# Daily Pre-Use Checklist

## Maeda Mini Crane

Northern (Head Office) Tel: +44 (0)1482 227333

Central Tel: +44 (0)1302 341659

Western Tel: +44 (0)1384 900388

Southern Tel: +44 (0)203 174 0658

www.hird.co.uk

|                                   |           |            |
|-----------------------------------|-----------|------------|
| Machine Model: <b>Maeda MC305</b> |           | Site Name: |
| Date Week Commencing:             | Fleet No: | Address:   |
| Inspected by:                     |           |            |

### Daily Pre-use Checks

|   |   | M | T | W | T | F | S | S | COMMENTS |
|---|---|---|---|---|---|---|---|---|----------|
| 1 | Are all operators manuals present and readable                        |   |   |   |   |   |   |   |          |
| 2 | Is the Report of Thorough Examination (LOLER) in date                 |   |   |   |   |   |   |   |          |
| 3 | Complete a visual walk around / Inspection for any noticeable defects |   |   |   |   |   |   |   |          |
| 4 | Are all safety information decals present and readable                |   |   |   |   |   |   |   |          |

### Check the following components or areas for damage, or missing parts & unauthorised modifications:

|    |  |  |  |  |  |  |  |  |  |
|----|--|--|--|--|--|--|--|--|--|
| 5  | Fuel Level                                   |  |  |  |  |  |  |  |  |
| 6  | Engine oil Level                             |  |  |  |  |  |  |  |  |
| 7  | Hydraulic oil level                          |  |  |  |  |  |  |  |  |
| 8  | Gauges and switches                          |  |  |  |  |  |  |  |  |
| 9  | Electrical components, wiring, connectors,   |  |  |  |  |  |  |  |  |
| 10 | Hydraulic hoses                              |  |  |  |  |  |  |  |  |
| 11 | Nut, bolts & other fasteners                 |  |  |  |  |  |  |  |  |
| 12 | Tracks                                       |  |  |  |  |  |  |  |  |
| 13 | Outriggers                                   |  |  |  |  |  |  |  |  |
| 14 | Outrigger Pads                               |  |  |  |  |  |  |  |  |
| 15 | Winch Cable serviceable                      |  |  |  |  |  |  |  |  |
| 16 | Drivers cabin in servicable condition        |  |  |  |  |  |  |  |  |
| 17 | Horn   |  |  |  |  |  |  |  |  |
| 18 | Audible / Visual warnings (Alarms & Beacons) |  |  |  |  |  |  |  |  |
| 19 | Controls, Buttons, Joysticks, Remote Control |  |  |  |  |  |  |  |  |
| 20 | Boom sections free from defects or debris    |  |  |  |  |  |  |  |  |
| 21 | Fly Jib free from defects (where applicable) |  |  |  |  |  |  |  |  |
| 22 | Hook in serviceable condition                |  |  |  |  |  |  |  |  |
| 23 | SLI unit operational                         |  |  |  |  |  |  |  |  |
| 24 | Drive function test                          |  |  |  |  |  |  |  |  |
| 25 | Crane function test                          |  |  |  |  |  |  |  |  |
| 26 | Emergency Stop button(s) function            |  |  |  |  |  |  |  |  |
| 27 | Carry out full function test                 |  |  |  |  |  |  |  |  |

|  |     |     |     |     |     |     |     |
|--|-----|-----|-----|-----|-----|-----|-----|
| <b>Is the machine safe to use?</b> (please circle) | YES | YES | YES | YES | YES | YES | YES |
|  | NO  | NO  | NO  | NO  | NO  | NO  | NO  |

|                            |  |  |  |  |  |  |  |
|----------------------------|--|--|--|--|--|--|--|
| <b>Operator's Initials</b> |  |  |  |  |  |  |  |
|----------------------------|--|--|--|--|--|--|--|

|  |
|--|
| <b>Result of Inspections: List defects or state "No Defects"</b> |
|  |

|                   |              |              |
|-------------------|--------------|--------------|
| <b>Signature:</b> | <b>Name:</b> | <b>Date:</b> |
|-------------------|--------------|--------------|